

3M Purification Inc.

3M™ ES Series ASME Code Filter Housings



Innovative
Filtration
Solutions

Quality. Consistency. Performance.



3M™ ES Series Filter Housings



Engineered For Safety, Flexibility, and Economy!

The result of 3M Purification Inc.'s unique Rapid Manufacturing System (RMS), a combination of advanced computer aided design and computer assisted manufacturing tools, the Express Series filter housing delivers what you want, when you want it! The Express Series (ES) industrial housings are high quality ASME Code design housings available with various cartridge diaphragms to accommodate double open end (DOE), single open end (SOE), and Zeta Plus™ style filter cartridges. The filter housing, with outside diameters from 8 to 36 inches, can contain from 3 to 120 DOE or SOE cartridges of various heights, or up to 12 Zeta Plus cartridges, depending on the diaphragm chosen. The vessel includes ASME Code stamp and National Board certification to assure the customer that all materials and fabrication procedures meet the most stringent requirements.

The standard housing is offered with 150 or 300 psi designs and can be easily configured for specific system requirements. Options such as outlet and cover lifting device location (not available on model ES08), radiography, and surface finish can be added onto the base model to create one of the most versatile filter vessels in the industry.

Features

- ASME Code design with stamp to ensure safety
- Available in 150 or 300 psi units
- Manufactured from 304L, 316L, or carbon steel to meet application requirements; special materials upon request
- User-friendly cover lifting device for easy cartridge changeouts
- DOE, SOE, and Zeta Plus Cartridge styles available for maximum filter cartridge applicability
- Available for cartridge lengths from 20" - 40"
- Nitrile, EPR, fluorocarbon or PTFE-encapsulated fluorocarbon gasket materials
- Up and downstream gauge ports and drains

Options

- Corrosion allowance available, consult factory
- Side outlet and cover lifting device location can be 90, 180 or 270° from the inlet.
- Standard swing bolt or Fast-Hex® bolt cover fasteners
- Full or spot radiography
- Choice of inlet/outlet flange size.

Applicable 3M Purification Inc. Filter Cartridges

Filter Product	Literature	Filter Product	Literature
Betapure™ AU Series	70-0201-8690-7 (LITCBP001)	Micro-Klean™ CS Series	70-0201-8771-5 (LITMPF001)
Betapure™ BK Series	70-0201-8688-1 (LITCBK001)	Betafine™ PP & PG Series	70-0201-8787-1 (LITPPC01)
Betapure™ PK Series	70-0201-8718-6 (LITCPK1)	Betafine™ PEG Series	70-0201-8789-7 (LITPXLEL)
Betafine™ DP Series	70-0201-8617-0 (LITBFD2)	Micro-Klean™ RT Series	70-0201-8723-6 (LITCPOLYKLN)
Micro-Klean™ RB Series	70-0201-8714-5 (LITCMK001)	Zeta Plus™	70-0201-8873-9 (LITZPU02)
Micro-Klean™ D Series	70-0201-8716-0 (LITCMW001)		

Please note that double open-end cartridges require spring and seal assemblies. 3M Purification Inc. replacement media can include the integral spring end treatment, which eliminates the need for spring and seal assemblies.

3M™ ES Series Filter Housing Specifications

General Information

The 3M™ ES series filter housing has the broadest range of configurations available in a standard filter housing line. The user can select from a wide variety of size, materials, pressure ratings, and many other features. Table 1 lists the Express Series housing general specifications.

Table 1.— General Housing Specifications

Base Model	Material	Standard Flange (inches)	Aqueous Flow* @ 2 psid Housing Pressure Drop (gpm/lpm)
ES08	Carbon Steel, 304L Stainless Steel, Or 316L Stainless Steel	2	92 / 348
ES12		3	196 / 742
ES14		4	317 / 1200
ES16		4	362 / 1370
ES20		6	6 669 / 2532
ES24		6	805 / 3047
ES30		8	1369 / 5182
ES36		10	2045 / 7740

Applies to ALL 3M™ ES Series Filter Housings

Housing Material	Pressure @ Temperature
Carbon Steel	150 psi @ 450 °F (10 bar @ 232 °C)
	300 psi @ 450 °F (20 bar @ 232 °C)
Stainless Steel	150 psi @ 250 °F (10 bar @ 121 °C)
	300 psi @ 250 °F (20 bar @ 121 °C)
Drains	1 ½" NPT Female
Gauge Connections	¼" NPT Female
Vent	1" NPT Female

* Flow rate for DOE Standard housings without filters installed. The actual flow rate will be dictated by the filter media and cartridge style used. The total filter pressure drop is the sum of the housing drop and the cartridge drop.

Housing Dimensions

The 3M ES series filter housing is designed and manufactured using state-of-the-art techniques. By engineering flexibility in design and exploiting advances in metal fabrication, 3M Purification Inc. is able to offer a “custom” design in a “standard” product line - in the same production cycle time as “off-the-shelf” product. Use Figure 1 in conjunction with Table 2 to determine general dimensions for a specific housing style. These measurements can be used to determine over-all space requirements. For all other uses, request a certified drawing.

Table 2. – General Housing Dimensions

Base Model	A			B	C	D	E
	2 High	3 High	4 High				
All Dimensions = Inches							
ES08	52	62	72	18	21	8	39
ES12	62	72	82	18	21	10	39
ES14	65	75	85	22	23	11	45
ES16	65	75	85	22	23	12	45
ES20	69	79	89	23	26	15	49
ES24	69	79	89	23	26	17	49
ES30	76	86	96	24	32	20	56
ES36	76	86	96	24	32	23	56

Bottom Outlet Housing Dimensions (Inches)

ES08	52	62	72	27	11	8	38
ES12	61	71	81	27	11	10	38
ES14	64	74	84	30	13	11	43
ES16	64	74	84	30	13	12	43
ES20	70	80	90	33	17	15	50
ES24	70	80	90	33	17	17	50
ES30	80	90	100	36	24	20	60
ES36	80	90	100	36	24	23	60

3M™ ES Series Filter Housings with Cover Lifting Device

(Models ES12 through ES36)

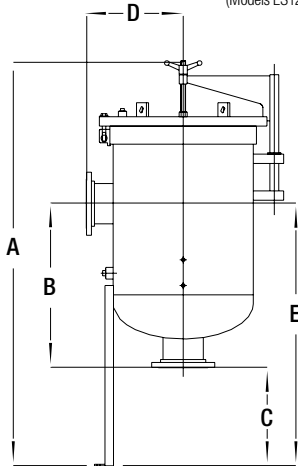

Bottom Outlet

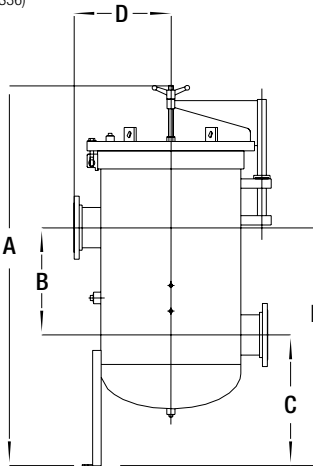

Side Outlet

3M™ ES Series Filter Housings without Cover Lifting Device

(Model ES08)

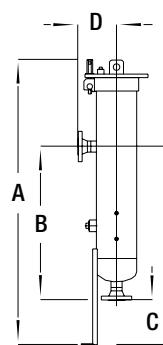

Bottom Outlet

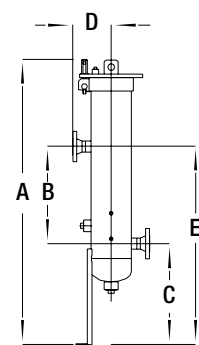

Side Outlet

3M™ ES Series Filter Housing

3M Purification Inc.

Featuring

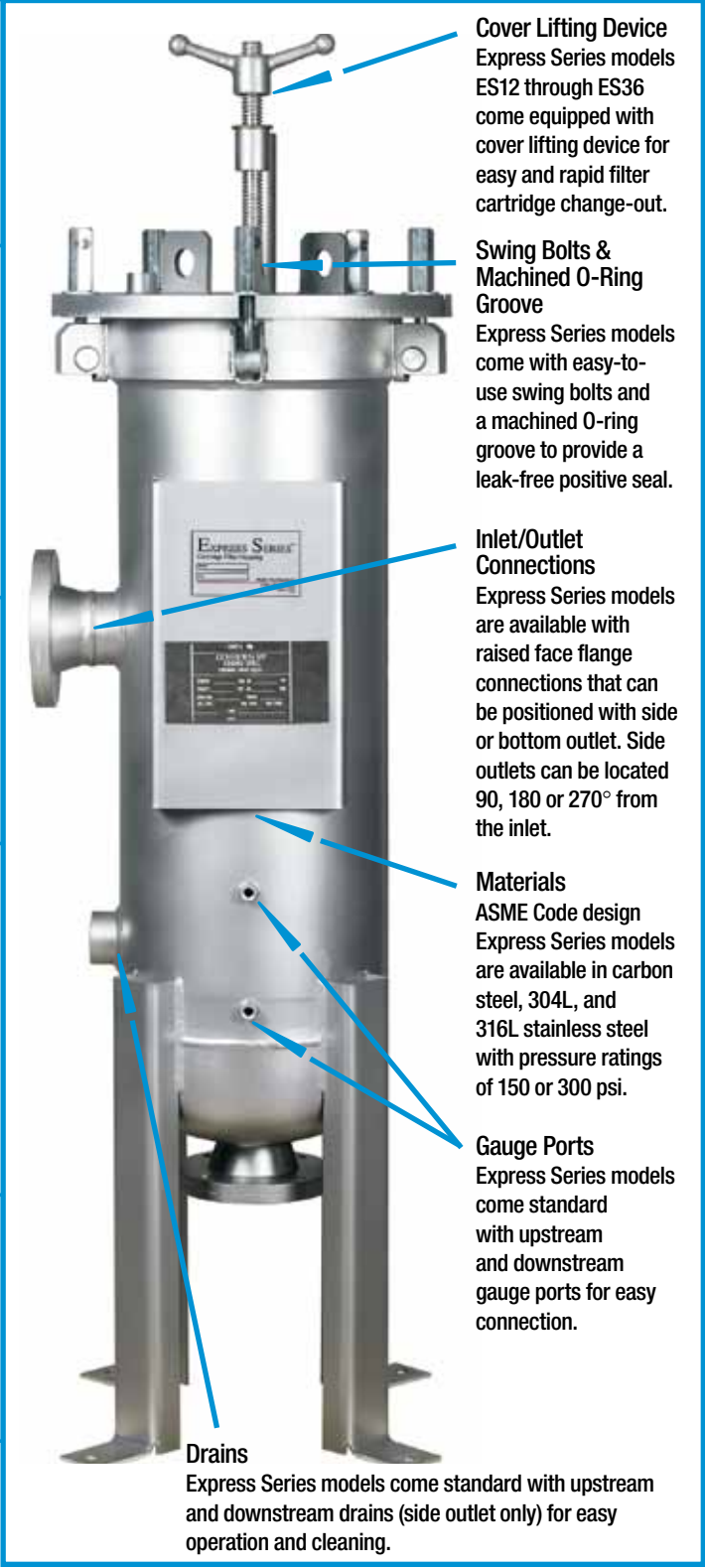

Cover Lifting Device
Express Series models ES12 through ES36 come equipped with cover lifting device for easy and rapid filter cartridge change-out.

Swing Bolts & Machined O-Ring Groove
Express Series models come with easy-to-use swing bolts and a machined O-ring groove to provide a leak-free positive seal.

Inlet/Outlet Connections
Express Series models are available with raised face flange connections that can be positioned with side or bottom outlet. Side outlets can be located 90, 180 or 270° from the inlet.

Materials
ASME Code design
Express Series models are available in carbon steel, 304L, and 316L stainless steel with pressure ratings of 150 or 300 psi.

Gauge Ports
Express Series models come standard with upstream and downstream gauge ports for easy connection.

Drains
Express Series models come standard with upstream and downstream drains (side outlet only) for easy operation and cleaning.



Filter Cartridge Styles*

* Note: Housing configuration is dependent on cartridge style. Cartridge styles are not interchangeable.

The Only ASME Code Design Housing That Combines Flexibility and Economy!

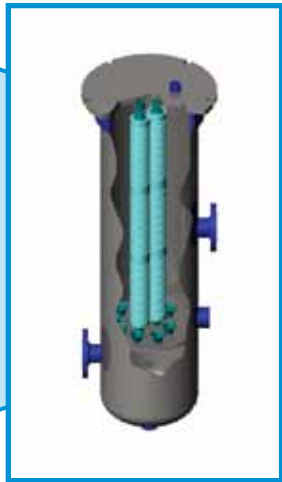

Filter Housing Styles

Double-Open-End Cartridge Capacity Number of Cartridges/ Total Equivalent Single Length Elements (10" nominal)

Cartridge Style D = Double Open End (2.625" Max. Diameter)

Housing Height	Housing Diameter							
	08	12	14	16	20	24	30	36
Two High	6/12	12/24	18/36	24/48	36/72	52/104	85/170	120/240
Three High	6/18	12/36	18/54	24/72	36/109	52/156	85/255	120/360
Four High	6/24	12/48	18/72	24/96	36/144	52/208	85/340	120/480

Cartridge Style P = Double Open End (3" Max. Diameter x 36" Long)

Petro-Klean Only	3	9	12	17	27	39	63	91
------------------	---	---	----	----	----	----	----	----

Single-Open-End Cartridge Capacity Number of Cartridges/ Total Equivalent Single Length Elements (10" nominal)

Cartridge Style T = 222 Double O-ring (2.813" Max. Diameter)

Housing Height	Housing Diameter							
	08	12	14	16	20	24	30	36
Two High	4/8	12/24	14/28	19/38	28/56	44/88	71/142	99/198
Three High	4/12	12/36	14/42	19/57	28/84	44/132	71/213	99/297
Four High	4/16	12/48	14/56	19/76	28/112	44/176	71/284	99/396

Cartridge Styles S = 226 Bayonet Lock (2.813" Max. Diameter)

Two High	4/8	8/16	12/24	17/34	25/50	38/76	67/134	77/154
Three High	4/12	8/24	12/36	17/51	25/75	38/76	67/201	77/231
Four High	4/16	8/32	12/48	17/68	25/100	38/152	67/268	77/308

Zeta Plus™ Cartridge Capacity

Cartridge Style Z = 12" & 16" Nom. Diameter

Housing Height	Housing Diameter		
	16	20	30
Three High	3 - 12" Cartridges	3 - 16" Cartridges	12 - 12" Cartridges

3M™ ES Series Filter Housing

Typical Flow Rate vs. Pressure Drop

Double Open End (standard)

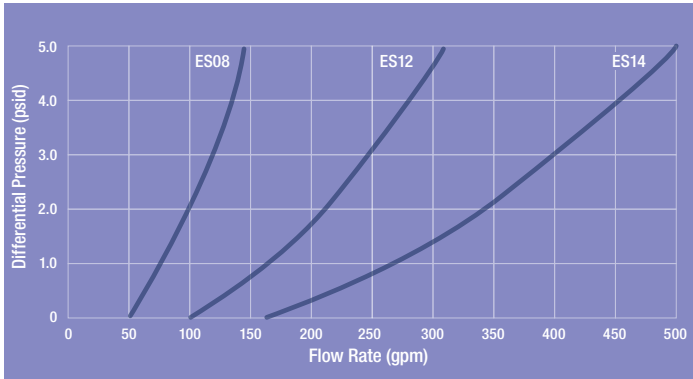

Double Open End (standard)

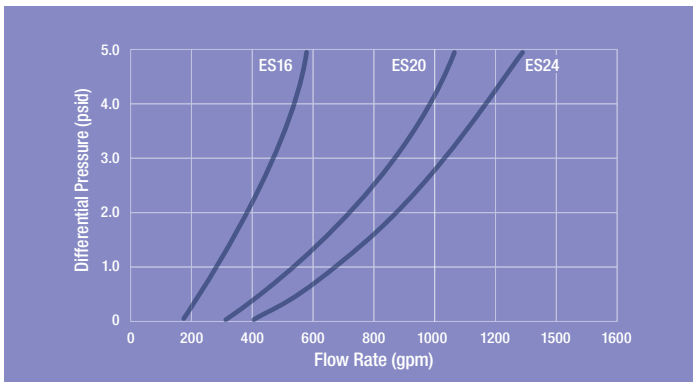

Double Open End (standard)

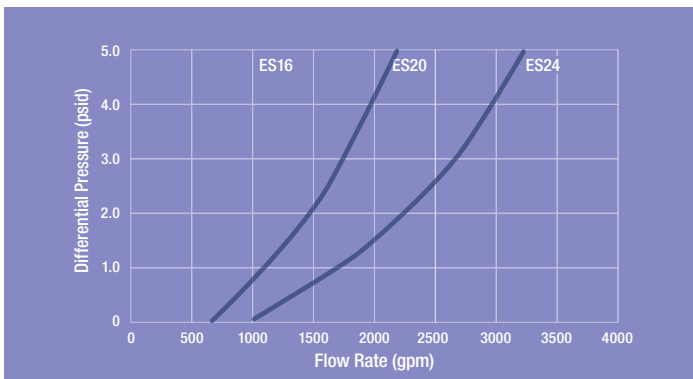

For Flow Rate vs Differential Pressure information for all other 3M™ ES series filter housing configurations, consult your local 3M Purification Inc. Distributor and ask for 70-0201-8801-0 (LITDESFL0).

3M™ ES Series Filter Housing Ordering Guide

Advanced computer aided design and computer integrated manufacturing technologies ensure compliance with design standards while allowing production of custom configurations in the standard manufacturing process. Each housing is identified by a general model and unique serial number to allow use of both standard replacement parts, where possible, and specials where required.

Please note that the housing configuration is dependent on cartridge style and that cartridge styles are not interchangeable. System flow rates and pressure drops are dictated by the filter medium used. For assistance in system sizing, contact your local 3M Purification Inc. Master Distributor or call 3M Purification Inc. Technical Sales.

3M™ ES Series Filter Housings

The following is an example of an Express Series housing model designation. Use this as a guide when ordering.

Housing Model	Housing Diameter	Number of Cartridges	Cartridge Style	Cartridge Height	Material	Pressure Rating	Gasket Material	Outlet Location	Cover Bolt Style
ES	08	006	D = DOE	2 = 2 High	A = Carbon Steel	1 = 150 psi	GA = Nitrile	E1 = Bottom	BB = Bolt

The resulting model is ES08006D2A1GAE1BB. Other options, such as cover lifting device location, are added after bolt style.

3M™ ES Series (Double-Open-End Cartridge) Filter Housing Ordering Guide

Double Open End (10" EQSL) Cartridge Style

Housing Model	Housing Diameter	Number of Cartridges	Cartridge Style	Cartridge Height	Material	Pressure Rating	Gasket Material	Outlet Location*	Cover Bolt Style
ES	08	006	D = DOE	2 = 2 high	A = Carbon Steel B = 304L SS C = 316L SS	1 = 150 psi 2 = 300 psi	GA = Nitrile GB = EPR GC Fluorocarbon GD = PTFE-Encapsulated Fluorocarbon	E1 = Bottom E2 = Side 90° E3 = Side 180° E4 = Side 270°	BB = Bolt BF = Fast Hex
	12	012		3 = 3 High					
	14	018		4 = 4 High					
	16	024							
	20	036							
	24	052							
	30	085							
	36	120							

Double Open End (Betapure™ PK – 36" long) Cartridge Style

Housing Model	Housing Diameter	Number of Cartridges	Cartridge Style	Cartridge Height	Material	Pressure Rating	Gasket Material	Outlet Location*	Cover Bolt Style
ES	08	003	P = Petro-Klean	3 = 3 High	A = Carbon Steel B = 304L SS C = 316L SS	1 = 150 psi 2 = 300 psi	GA = Nitrile GB = EPR GC Fluorocarbon GD = PTFE-Encapsulated Fluorocarbon	E1 = Bottom E2 = Side 90° E3 = Side 180° E4 = Side 270°	BB = Bolt BF = Fast Hex
	12	009							
	14	012							
	16	017							
	20	027							
	24	039							
	30	063							
	36	091							

* Outlet location is from housing top-view clockwise from inlet center line.

3M™ ES Series Filter Housings for use with Plug-In Style Filter Cartridges

Single Open End (222 O-ring) Cartridge Style

Housing Model	Housing Diameter	Number of Cartridges	Cartridge Style	Cartridge Height	Material	Pressure Rating	Gasket Material	Outlet Location*	Cover Bolt Style
ES	08	004	T = 222 O-ring & Spear	2 = 2 High 3 = 3 High 4 = 4 High	A = Carbon Steel B = 304L SS C = 316L SS	1 = 150 psi 2 = 300 psi	GA = Nitrile GB = EPR GC Fluorocarbon GD = PTFE-Encapsulated Fluorocarbon	E1 = Bottom E2 = Side 90° E3 = Side 180° E4 = Side 270°	BB = Bolt BF = Fast Hex
	12	012							
	14	014							
	16	019							
	20	028							
	24	044							
	30	071							
	36	099							

Single Open End (226 Bayonet Lock) Cartridge Style

Housing Model	Housing Diameter	Number of Cartridges	Cartridge Style	Cartridge Height	Material	Pressure Rating	Gasket Material	Outlet Location*	Cover Bolt Style
ES	08 12 14 16 20 24 30 36	004 008 012 017 025 038 067 077	S = 226 O-ring & Spear	2 = 2 High 3 = 3 High 4 = 4 High	A = Carbon Steel B = 304L SS C = 316L SS	1 = 150 psi 2 = 300 psi	GA = Nitrile GB = EPR GC Fluorocarbon GD = PTFE- Encapsulated Fluorocarbon	E1 = Bottom E2 = Side 90° E3 = Side 180° E4 = Side 270°	BB = Bolt BF = Fast Hex

3M™ ES Series Zeta Plus™ Filter Housings Ordering Guide – 12” & 16” Diameter Cartridges

Housing Model	Housing Diameter	Number of Cartridges	Cartridge Style	Cartridge Height	Material	Pressure Rating	Gasket Material	Outlet Location*	Cover Bolt Style
ES	16 20 30	001 - 12” Ctg 001 - 16” Ctg 004 - 12” Ctg	Z = Zeta Plus	3 = 3 High	A = Carbon Steel B = 304L SS C = 316L SS	1 = 150 psi 2 = 300 psi	GA = Nitrile GB = EPR GC Fluorocarbon GD = PTFE- Encapsulated Fluorocarbon	E1 = Bottom E2 = Side 90° E3 = Side 180° E4 = Side 270°	BB = Bolt BF = Fast Hex

3M™ ES Series Filter Housings Option Ordering Guide

Cover Lifting Device Location	Radiography	Inlet/Outlet Connection Size (see table to right)	Surface Finish	Inlet/Outlet Connection Size (Inches)								
A1 = Side 90° A2 = Side 180° (default) A3 = Side 270°	R1 = None R2 = Spot R3 = Full	N1 = Default N2 = Next Size Smaller N3 = Next Size Bigger	Y = Default Y2 = Pickle & Passivate	Model	ES08	ES12	ES14	ES16	ES20	ES24	ES30	ES36
				Next Size Smaller	NA	2	3	3	4	4	6	8
				Next Size Larger	NA	4	6	6	8	8	10	12

Important Notice

The information described in this literature is accurate to the best of our knowledge. A variety of factors, however, can affect the performance of the Product(s) in a particular application, some of which are uniquely within your knowledge and control. **INFORMATION IS SUPPLIED UPON THE CONDITION THAT THE PERSONS RECEIVING THE SAME WILL MAKE THEIR OWN DETERMINATION AS TO ITS SUITABILITY FOR THEIR USE. IN NO EVENT WILL 3M PURIFICATION INC. BE RESPONSIBLE FOR DAMAGES OF ANY NATURE WHATSOEVER RESULTING FROM THE USE OF OR RELIANCE UPON INFORMATION.**

It is your responsibility to determine if additional testing or information is required and if this product is fit for a particular purpose and suitable in your specific application.

3M PURIFICATION INC. MAKES NO REPRESENTATIONS OR WARRANTIES, EITHER EXPRESS OR IMPLIED INCLUDING WITHOUT LIMITATION ANY WARRANTIES OF MERCHANTABILITY, FITNESS FOR A PARTICULAR PURPOSE OR OF ANY OTHER NATURE HEREUNDER WITH RESPECT TO INFORMATION OR THE PRODUCT TO WHICH INFORMATION REFERS.

Limitation of Liability

3M Purification Inc. will not be liable for any loss or damage arising from the use of the Product(s), whether direct, indirect, special, incidental, or consequential, regardless of the legal theory asserted, including warranty, contract, negligence or strict liability. Some states do not allow the exclusion or limitation of incidental or consequential damages, so the above limitation may not apply to you.

Your Local Distributor:



3M Purification Inc.
400 Research Parkway
Meriden, CT 06450
U.S.A.
Phone (800) 243-6894
(203) 237-5541
Fax (203) 630-4530
www.3mpurification.com

3M is a trademark of 3M Company.
Zeta Plus and Betapure are trademarks
of 3M Company used under license.
All other trademarks are the property of their respective owners.
© 3M 2011. All rights reserved.
70-0201-8711-1 1011vb