

Honeywell



GR Series and DR Graphic Recorders

DR Graphic, Multitrend GR, Minitrend GR and eZtrend GR

See, Store and Send Data Securely

For the best in Display Versatility, Analysis and Communications ..

choose **Honeywell**

User manual

Table of Contents

| | |
|--|-----------|
| Section 1: Preface | 1 |
| Preface | 1 |
| <i>Thank you for choosing a Honeywell GR Series recorder</i> | 1 |
| <i>Documentation</i> | 1 |
| <i>Notes</i> | 1 |
| <i>Trademarks</i> | 1 |
| Safety | 2 |
| <i>Symbols</i> | 2 |
| <i>Static Electricity</i> | 3 |
| Protocols used in this manual | 3 |
| <i>Safety and Symbol Identification</i> | 3 |
| Warnings and Safety Precautions | 3 |
| <i>Do's and Don'ts</i> | 3 |
| <i>Hazardous Voltage</i> | 4 |
| <i>For use in hazardous locations</i> | 5 |
| Section 2: Installation | 7 |
| Environment and Location | 7 |
| Mechanical Installation | 8 |
| <i>Installation Instructions</i> | 11 |
| Electrical Installation | 22 |
| <i>Installation Category</i> | 22 |
| <i>Analogue Input Card</i> | 29 |
| eZtrend GR Analogue Input (Standard) card | 32 |
| <i>Analogue Output Card</i> | 33 |
| <i>Pulse Input Card</i> | 35 |
| <i>Transmitter Power Supply Card</i> | 37 |
| <i>Alarm Relay Cards & Digital Input/Output Cards</i> | 38 |
| <i>Communications Connections</i> | 42 |
| <i>USB Devices</i> | 44 |
| Section 3: Overview | 45 |
| Functions and Features | 45 |
| <i>Recorder Functionality</i> | 47 |
| <i>Features</i> | 49 |
| <i>Options - Hardware</i> | 55 |
| Section 4: Recorder Setup | 63 |
| Power up | 63 |
| 1. <i>Menu Access</i> | 63 |
| 2. <i>Log On/Off</i> | 64 |
| 4. <i>Time and Date Settings</i> | 65 |
| 5. <i>Firmware Options</i> | 65 |
| <i>Menu Path</i> | 65 |
| <i>Help</i> | 66 |
| <i>Configure Menu</i> | 67 |
| <i>Setup Menu</i> | 68 |
| <i>Edit Recording</i> | 148 |



| | |
|---------------------------------------|-----|
| <i>Reports Menu</i> | 153 |
| <i>Layout</i> | 157 |
| <i>Passwords</i> | 164 |
| <i>Settings</i> | 173 |
| <i>Alarms Menu</i> | 175 |
| <i>Screen Menu</i> | 176 |
| <i>Batch Setup/Batch Groups</i> | 180 |
| <i>Recording Menu</i> | 184 |
| <i>Messages Menu</i> | 187 |
| <i>Process Menu</i> | 190 |
| <i>Status Menu</i> | 194 |
| <i>Finish</i> | 206 |

Section 5: Security 207

| | |
|--|-----|
| <i>Password Security</i> | 207 |
| <i>Users and Groups</i> | 207 |
| <i>Administrator</i> | 208 |
| <i>Password Policy</i> | 210 |
| <i>User Interface requirements</i> | 210 |
| <i>Audit Trail</i> | 210 |
| <i>Level Permissions</i> | 211 |
| <i>Default Password Access</i> | 214 |
| <i>Hardware Configuration Lock</i> | 224 |

Section 6: Screen Configuration 225

| | |
|--------------------------------------|-----|
| <i>Process Screen Overview</i> | 225 |
| <i>Menu Bar</i> | 226 |
| <i>Screen Menu Bar</i> | 227 |
| <i>Replay</i> | 228 |
| <i>Chart Speeds</i> | 235 |
| <i>Hot Button</i> | 235 |
| <i>Screen Activity</i> | 236 |

Section 7: Firmware Options 241

| | |
|-------------------------------------|-----|
| <i>Firmware Credit System</i> | 241 |
| <i>Firmware Options</i> | 243 |

Section 8: Communication 245

| | |
|--|-----|
| <i>Comms Configuration</i> | 245 |
| <i>Standard Communication Interfaces</i> | 245 |
| <i>Protocols</i> | 246 |
| <i>Hardware Installation</i> | 247 |
| <i>Getting connected - IP Address</i> | 248 |
| <i>Local Area Network setup</i> | 249 |
| <i>Links to Remote Networks</i> | 249 |
| <i>Data Logging and Transfer</i> | 249 |
| <i>Comms and Trend Manager Suite</i> | 251 |
| <i>System Requirements</i> | 252 |
| <i>Software Installation</i> | 253 |
| <i>Start Up</i> | 254 |



| | |
|------------------------------------|-----|
| Communications Server | 258 |
| <i>Comms Server Overview</i> | 258 |
| <i>Comms Server Start up</i> | 258 |
| <i>Comms Server Setup</i> | 261 |
| <i>Comms Server Logging</i> | 266 |
| Comms Server Database | 274 |
| <i>System Setup</i> | 274 |
| Shutdown Server | 274 |
| <i>Modbus Capabilities</i> | 275 |
| Web Browser | 276 |
| Internet Security Settings | 277 |

Section 9: PC Software Suite 279

| | |
|---|-----|
| <i>The TrendManager Pro Software Suite</i> | 279 |
| <i>X Series & GR Recorder Screen Designer</i> | 279 |
| <i>Database Management Tool</i> | 280 |
| <i>Report Generation Tool - AMS2750</i> | 280 |
| <i>System Requirements</i> | 280 |

Section 10: Spares List 281

| | |
|-------------------------------------|-----|
| <i>Minitrend GR Recorder</i> | 281 |
| <i>Multitrend GR Recorder</i> | 285 |
| <i>eZtrend GR Recorder</i> | 291 |
| <i>DR Graphic Recorder</i> | 295 |

Section 11: Instrument Care and Maintenance 301

| | |
|---------------------------------------|-----|
| Instrument Care and Maintenance | 301 |
| <i>Cleaning Instructions</i> | 301 |
| <i>Backlights</i> | 301 |
| <i>Operating Temperature</i> | 301 |
| <i>Touch Screen</i> | 302 |
| <i>Calibration</i> | 302 |

Section 12: Technical Data & Specifications 303

| | |
|---|-----|
| Field IO Specification | 303 |
| Analogue Input | 304 |
| Relay Alarm/Digital Input Specification | 304 |
| <i>Relay/Alarm Output Card Options</i> | 304 |
| <i>Digital Input Cards</i> | 305 |
| <i>Specification Tables</i> | 307 |
| <i>Input Range Performance Accuracy Table</i> | 312 |
| <i>Input Actuation</i> <i>(Linear)</i> | 312 |
| <i>Input Actuation</i> | 313 |
| <i>LED Flash Codes</i> | 317 |

Appendix A: Quality and Safety 319

| | |
|---------------|-----|
| CE Mark | 319 |
| Safety | 319 |

| | |
|---|------------|
| Appendix B: Maths Expressions | 321 |
| Full Maths & Script Processing | 321 |
| <i>Maths Credit Options</i> | 321 |
| <i>Maths Variable and Function Tables</i> | 322 |
| <i>Full Maths</i> | 330 |
| <i>Script Function Application Examples</i> | 331 |
| <i>Maths Error Messages</i> | 336 |
| Appendix C: Thermocouple Connections | 337 |
| How Thermocouples work | 337 |
| Thermocouple CJC Compensation | 338 |
| <i>Internal Automatic</i> | 338 |
| <i>Ext 0°C Reference</i> | 339 |
| <i>External with a Specified Temperature</i> | 339 |
| <i>External Input Reference</i> | 340 |
| Appendix D: Alarms | 341 |
| <i>Alarms Menu</i> | 341 |
| Appendix E: Ethernet | 343 |
| <i>Ethernet</i> | 343 |
| <i>Email</i> | 344 |
| <i>General operation of the e-mail system</i> | 344 |
| Appendix F: Fuzzy Logging | 345 |
| Appendix G: F sub zero Sterilisation | 349 |
| <i>The significance of F0</i> | 349 |
| Appendix H: Calibration | 351 |
| AI Calibration and CJC Calibration | 351 |
| Sensor Compensation | 351 |
| Appendix I: Battery Data | 353 |
| Location: Processor Board | 353 |
| <i>Safety Guidelines</i> | 353 |
| Appendix J: Function Codes and Memory Maps | 355 |
| Modbus Memory Map Supplement: | 355 |
| <i>Totalisers</i> | 360 |
| <i>Input Text message</i> | 360 |
| <i>Analogue Input Value</i> | 360 |
| <i>Communications Input</i> | 360 |
| <i>Pen Values</i> | 361 |
| Modbus Function Codes | 362 |
| Appendix K: Troubleshooting | 363 |
| Error Messages | 363 |

| | |
|---|------------|
| Appendix L: GR Series AMS2750 capabilities | 377 |
| AMS2750 and the GR Series Recorders | 377 |
| AMS2750 Process mode | 378 |
| AMS2750 Credit Option | 378 |
| AMS2750 Process Menu | 379 |
| AMS2750 Process Screen | 379 |
| SAT | 383 |
| I/O + AMS2750 (Process Mode) | 383 |
| AMS2750 Button (Process Mode) | 385 |
| Pens for TC's (Process Mode) | 389 |
| Thermocouple Usage Tracking (AMS2750) | 390 |
| TUS mode | 392 |
| Temperature Uniformity Survey (TUS) Mode | 392 |
| AMS2750 (TUS) - Credit Option | 393 |
| AMS2750 (TUS) Screen | 394 |
| I/O + AMS2750 (TUS) | 394 |
| AMS2750 Menu (TUS) | 395 |
| Pens for TC's (TUS Mode) | 401 |
| TUS survey process screen | 402 |
| Start a Survey | 410 |
| During survey | 410 |
| Events (AMS2750) | 416 |
| Audit Trail (AMS2750) | 417 |
| TUS Data file | 417 |
| TUS Logged data | 418 |
| Passwords (AMS2750) | 419 |
| TrendManager SuiteSoftware (AMS2750) | 420 |
| Screen Designer (AMS2750) | 420 |
| AMS2750 Report Generation Tool | 421 |
| Installation | 421 |
| Introduction | 423 |
| Report Tool User Interface | 423 |
| Browse Logo | 424 |
| SAT Report Wizard | 425 |
| TUS Report Wizard | 428 |
| Index | 449 |



Section 1: Preface

Preface

Thank you for choosing a Honeywell GR Series recorder

Thank you for purchasing the newest in our range of electronic data recording for **GR** Advanced Graphic Recorders.

The **Minitrend GR**, **Multitrend GR** **eZtrend GR** and **DR Graphic** paperless chart recorders are the latest development of the solid-state replacement for traditional paper recorders.

Many options, features and functions are available to meet a wide range of applications and requirements including: Power, Water Treatment, Thermal Processing, Food and Beverage, Pharmaceutical/Biotech and Manufacturing industries.

This manual explains the product functionality operation, configuration and communication as well as Safety Precautions, Installation & Wiring, Recorder Setup, Troubleshooting and Spares List. It is recommended that the user reads the manual before installing and operating the recorder.

Documentation

A full set of manuals for the software and the recorders (including some language versions) are available on the CD provided and from our website www.honeywellprocess.com.

Also Application Notes and Installation Instructions, first time password setup and database tool information.

Supplementary documentation to accompany these recorders are:

Table 1.1 : Supplementary documentation

| Manual | Part number |
|---------------------------------|-------------|
| TrendManager Pro Software Suite | 43-TV-25-11 |
| Screen Designer | 43-TV-25-31 |

Notes

- The contents of this manual are correct at the time of issue. The contents may change at any time without prior notification. This is due to continuous developments to the recorder and it's functionality.
- Every effort has been made to ensure the accuracy of this document, however should there be any anomalies found, please contact your nearest **Honeywell** supplier. See back page for contact addresses.
- All rights are reserved. No part of this manual should be copied or reproduced, stored on a retrieval system or transmitted in any form without the prior permission from **Honeywell** International Inc.

Trademarks

- Microsoft, MS-DOS, Windows 7, Windows 8, Windows Server 2008 and Windows 2012 Server are all registered trademarks of Microsoft corporation.

Safety



• *SD, SDHC and SDXC are trademarks or registered trademarks of SD-3C, LLC in the United States, other countries or both.

- For the purpose of this manual the TM and [®] symbols will not follow their own trademark names or registered trademark names in every instance.
- Company names and Product names mentioned in this manual are trademarks or registered trademarks of their individual owners.

Safety

The **GR Series** range of instruments is compliant with the requirements of BS EN 61010-1:2010 “Safety Requirements for Electrical Equipment for Measurement, Control and Laboratory Use” and UL 61010-1 (3rd Edition) and CAN/CSA-C22-2 No.61010-1-12, as options. If the equipment is used in a manner not specified, the protection provided by the equipment may be impaired.

The **GR Series** range of instruments are compliant to the requirements for Class 1, Div.2 Hazardous (Classified) Locations. Refer to the Model Selection Guide.

Symbols

One or more of the following symbols may appear on the recorder labelling.

Table 1.2 : Safety Symbols

| Symbol | Meaning |
|--------|---|
| | Caution - refer to manual for instructions |
| | Caution - risk of electric shock |
| | Direct Current |
| | Protective conductor terminal |
| | Earth (ground) terminal |
| | Static Electricity |
| | Directive 2002/96/EC WEEE: Waste Electrical and Electronic Equipment |



Static Electricity

All circuit boards and electronic modules associated with this recorder contain components which are susceptible to damage caused by electrostatic discharge. Should it be necessary to handle such components, appropriate precautions in accordance with ANSI/ESD S20.20 Electrostatic Discharge Control Program Standard, should be observed.

Protocols used in this manual

Safety and Symbol Identification

Table 1.3 :

| Symbol | Description |
|--|--|
|  WARNING | The WARNING symbol indicates a potentially hazardous situation, which, if not avoided, could result in death or serious injury . |
|  CAUTION | This CAUTION symbol may indicates a potentially hazardous situation, which, if not avoided, may result in property damage . |
| NOTICE | A NOTICE symbol indicates important information that must be remembered and aids in job performance. |

Warnings and Safety Precautions

Do's and Don'ts

1. DC inputs to the product should be provided by SELV power supply
2. The inputs of the product are supplied from SELV and should not exceed 50V.
3. Before any connections are made to the recorder, ensure the protective earth terminal is connected to a protective conductor before applying power or any other connections.

| |
|---|
|  WARNING IMPROPER INTERRUPTION OF CONNECTIONS Any interruption of the protective conductor outside the recorder, or disconnection of the protective earth terminal is likely to make the recorder dangerous under some fault conditions. Intentional interruption of the protective conductor is dangerous. Failure to comply with these instructions could result in death or serious injury. |
|---|

In order to comply with the requirements of safety standard EN 61010-1:2010, the recorder should have one of the following as a disconnecting device, located within easy reach of the operator, and be clearly labelled as the disconnecting safety device:

- A switch or circuit breaker which complies with the requirements of IEC 60947-1 and IEC 60947-3.

Warnings and Safety Precautions

- A separable coupler which can be disconnected without the use of a tool.
 - A separable plug, without a locking device, to mate with a socket outlet in the building.
4. Whenever it is likely that protection has been impaired, the recorder should be made inoperative and secured against operation. The manufacturer's service centre should be contacted.
 5. Repair is not to be attempted by a customer. Any adjustment or maintenance expected of an operator as part of the normal operation of the product is referred to as Operational Maintenance. Any maintenance not expected of the operator is referred to as Corrective Maintenance and is to be carried out only by authorized service personnel or returned to an authorized repair centre.
 6. Where conductive pollution such as condensation or conductive dust is present, adequate air conditioning, filtering and/or sealing must be installed.
 7. This recorder contains one battery on the Processor board which must be treated and disposed of with care. Batteries must not be short circuited. Batteries should be disposed of in accordance with local regulations, they must not be disposed of with normal refuse.
 8. Improper signal and supply wiring - WARNING



WARNING

IMPROPER SIGNAL AND SUPPLY WIRING

Signal and supply wiring should be kept separate. Where this is impractical, shielded cables should be used for the signal wiring. Where signal wiring is carrying, or could carry under fault conditions, hazardous voltage (defined as >30 V rms and 42.4 V peak, or >60 Vd.c.), double insulation must be used for all signal wiring.

Failure to comply with these instructions could result in death or serious injury.

9. If the equipment is used in a manner not specified by the manufacturer, the protection provided by the equipment may be inadequate.
10. The protective earth terminal must remain connected (even if the recorder is isolated from the mains supply) if any of the measuring, communications, or relay terminals are connected to hazardous voltages.

Hazardous Voltage

Hazardous Voltages are defined by EN61010-1 as follows:



WARNING

HAZARDOUS VOLTAGE LEVELS

Voltage levels above 30V rms and 42.4V peak or 60V dc are deemed to be "Hazardous Live". Ensure operators are not exposed to hazardous voltage levels.

Failure to comply with these instructions could result in death or serious injury.

Warnings and Safety Precautions

For use in hazardous locations

(only applicable to recorders with FM approval)

WARNING

EXPLOSION HAZARD

Do not remove or replace the Connectors, Fuse holders while circuit is live when Flammable or Combustible atmosphere is present

WARNING

EXPLOSION HAZARD

Do not disconnect equipment when a flammable or combustible atmosphere is present.

WARNING

EXPLOSION HAZARD

Do not open the enclosure or replace the battery when a flammable or combustible atmosphere is present

WARNING

EXPLOSION HAZARD

Do not connect or disconnect the equipment or memory card or USB device unless the power has been switched off or the area is known to be hazardous

NOTICE

The Front door is tool secured and do not intended to open during live condition or when flammable or combustible atmosphere is present. Ensure to lock the door for use in hazardous location.

In case of GR Mini /Multi the front door is tool secured with cable tie whereas in DR graphic recorder the front door is tool secured with Hex head Screw.

Warnings and Safety Precautions

Section 2: Installation

Damage checks

Any damage caused to the recorder or the contents should be reported immediately to your shipper.

Unpacking

Remove the contents, check the packaging and remove all documentation and accessories supplied. Retain the box and any packaging for future transportation.

Contents

Check that the contents and accessories are correct against the order or Model Selection Guide using the model number on the recorder. Contact your authorised **Honeywell** distributor or **Honeywell** immediately should there be any query.

The contents are based on Unit Model Number ordered and will vary from unit to unit. The following list is provided as a general guide and not specific to any single unit.

- Recorder - specification as ordered (check against the Model Selection Guide)
- Mounting fixings - Mounting clamps and panel gasket
- Connector kit - mating half connectors to recorder spec. Including a CJC connector for Thermocouple operation.
- Quick Start Guide - to get you started
- First time Password system instructions - for ESS recorders only
- CD - Viewer software + documentation
- Plastic stylus x 2 (for use with the touch screen)
- Manual (optional) - Hard copy English, French or German
- Any other items ordered as an option (Model Selection Guide)

Re-packing

NOTICE

Should the original packing be destroyed or lost, new packaging can be ordered or as a last alternative, then **ONLY** pack the recorder in polystyrene granules if the recorder is **FIRST** sealed in a strong plastic bag. Failure to do this will invalidate your warranty.

Environment and Location

- The recorder is designed to be mounted into a panel. [See “Installation Instructions” on page 11.](#)
- Mounting angle is unlimited. Choose a suitable location with an ideal viewing angle. [See “Mounting and Viewing Angles” on page 8.](#)
- The location should be free from vibration.
- The environment should be of non-condensing humidity.
- The ambient temperature should be between 0°C and 50°C (32°F to 122°F).
- The relative humidity should be between 10% to 90%.
- In the presence of sustained strong EM Field (~10V/m or higher), deviation from the accuracy specifications may occur. To improve performance under such installation scenarios we recommend using twisted pair cables and/or ferrite cylinders (over individual wires)

Mechanical Installation

Mounting and Viewing Angles

Mounting - The **Minitrend GR**, **Multitrend GR** and **eZtrend GR** recorders have an unlimited mounting angle.

Viewing - For the best view of the display the viewing angle should not exceed:

Minitrend GR 55° from the left or right, 40° looking down and 50° looking up at the recorder display.

Multitrend GR and **DR Graphic** 70° from the left or right, 45° looking down and 55° looking up at the recorder display.

eZtrend GR 45° from the left or right, 10° looking down and 30° looking up at the recorder display.

Panel cut-out size for the Minitrend GR and eZtrend GR recorders

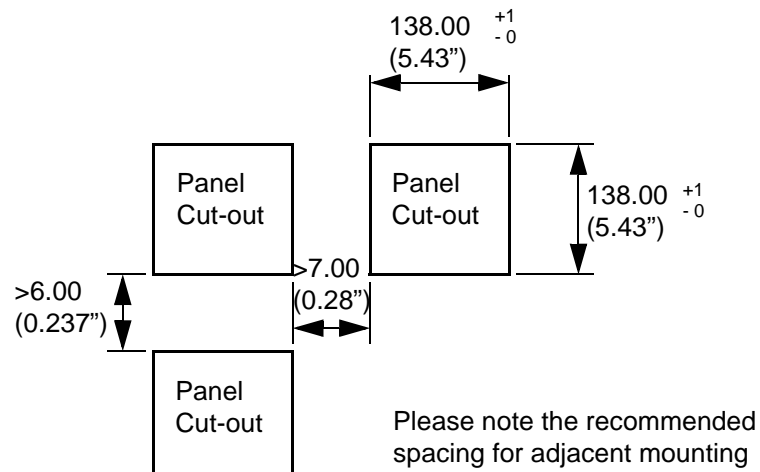

Figure 2.1 Minitrend GR and eZtrend GR Panel cut-out

Mechanical Installation

Panel cut-out size for the Multitrend GR recorder

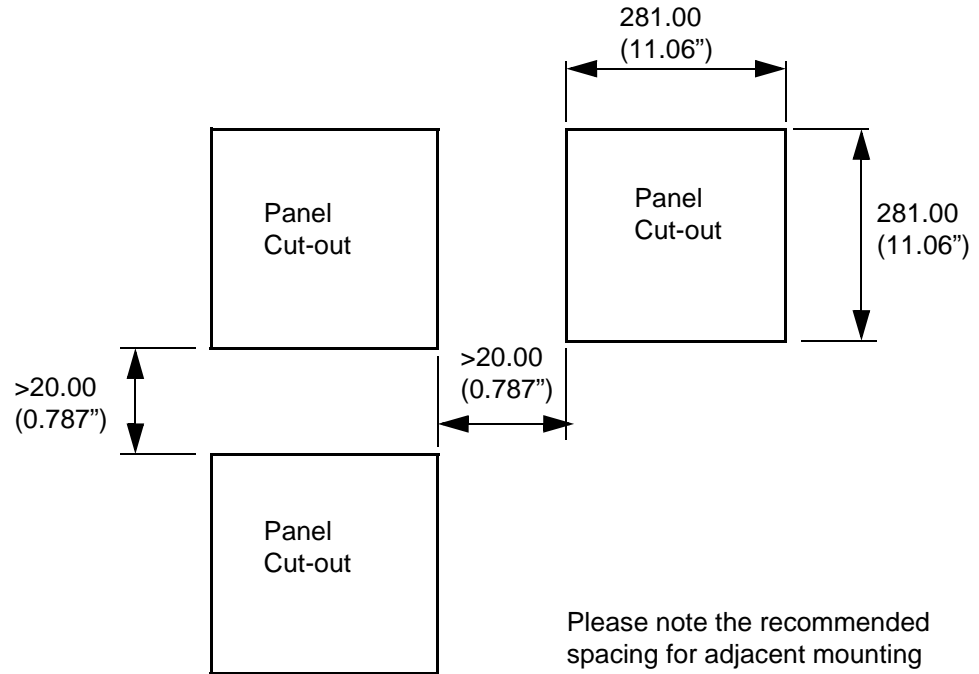

Figure 2.2> Multitrend GR Panel cut-out

The **Minitrend GR**, **Multitrend GR** and **eZtrend GR** recorders are DIN Standard sizes and should be panel mounted.

Panel cut-out size for the DR Graphic recorder

Physical considerations

The recorder can be mounted flush in a panel or on the surface of a panel or wall using the mounting kit supplied with the recorder. Adequate access space must be available at the back of the panel for installation and servicing.

Overall dimensions

The overall dimensions and panel cutout requirements for mounting the recorder are shown in Figure 2.3

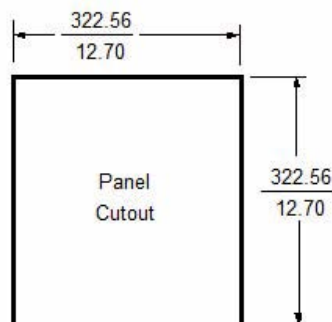
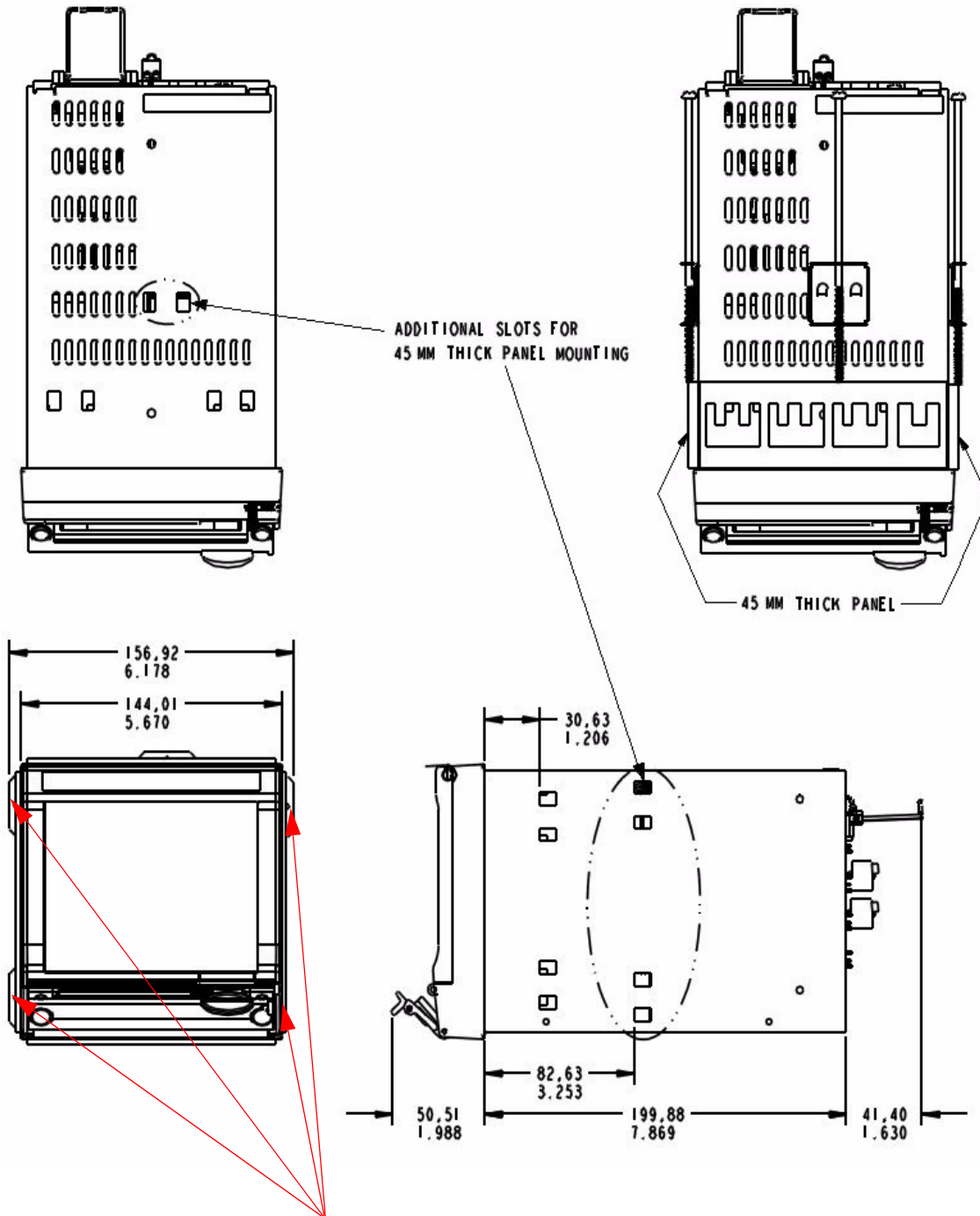

Figure 2.3>
DR Graphic recorder
Panel cut-out

Mechanical Installation

Minitrend GR Dimension details

Figure 2.4> Minitrend GR Recorder Dimensions and Mounting slots (including 45mm panel thickness)



4 Mounting clamp positions for 2 - 20mm panel thickness. For standard units fit only two brackets on opposite sides of the unit, either top and bottom or left and right slots. NEMA 4X rated recorders require all four mounting brackets to be fitted.

Mechanical Installation

Multitrend GR Dimension details

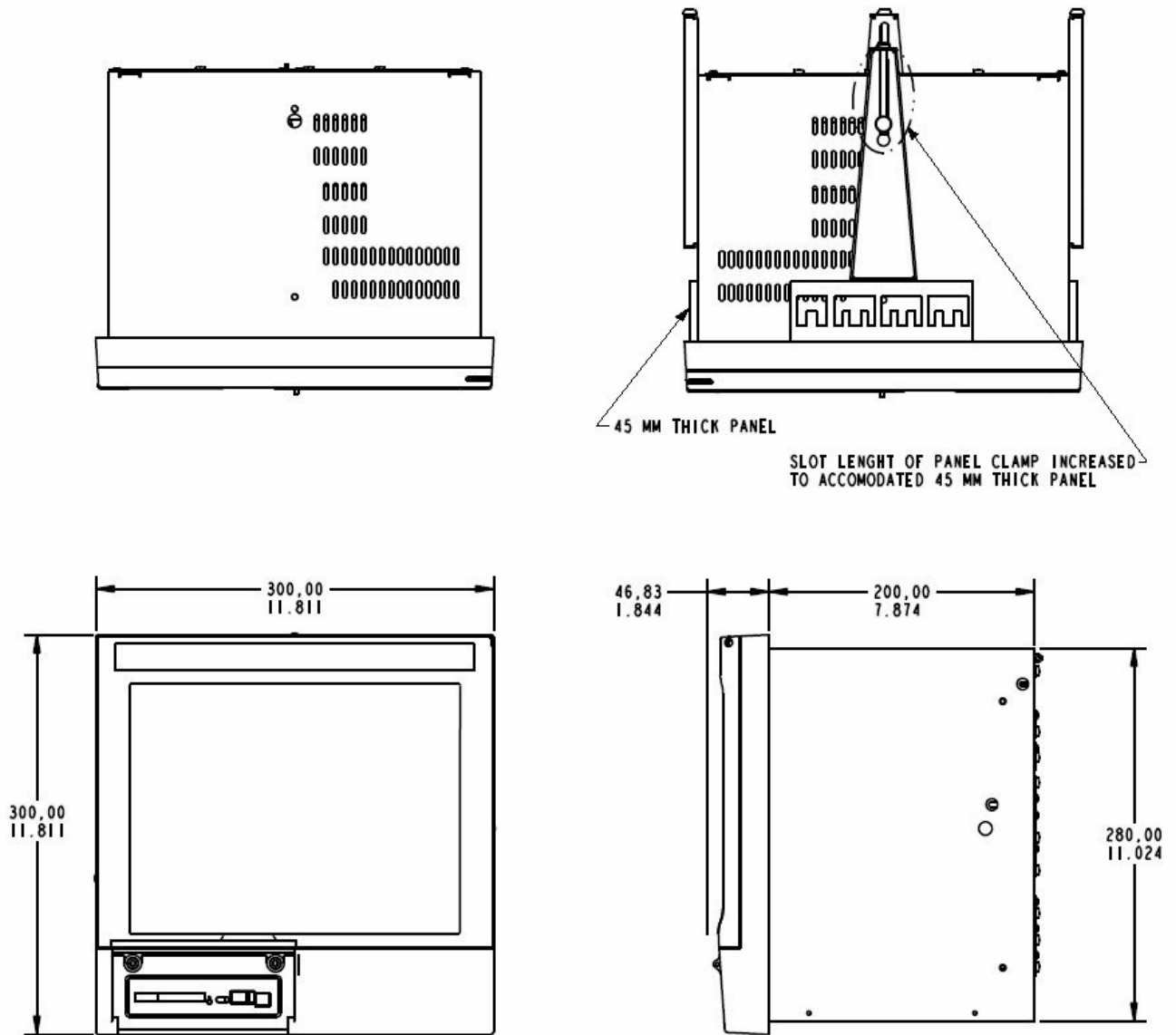

Figure 2.5> Multitrend GR Recorder Dimensions and Mounting slots
(including 45mm panel thickness)

Installation Instructions

- Minimum panel thickness = 2mm (0.078"), max = 20mm (0.78")
- Alternate panel mounting available thickness = 45mm (1.77")
- Both recorders must be inserted from the front of the panel,
- Two mounting clamps are supplied and can be fixed either on the top and bottom sides or on the left and right sides of the case.

Mechanical Installation

eZtrend GRDimension details

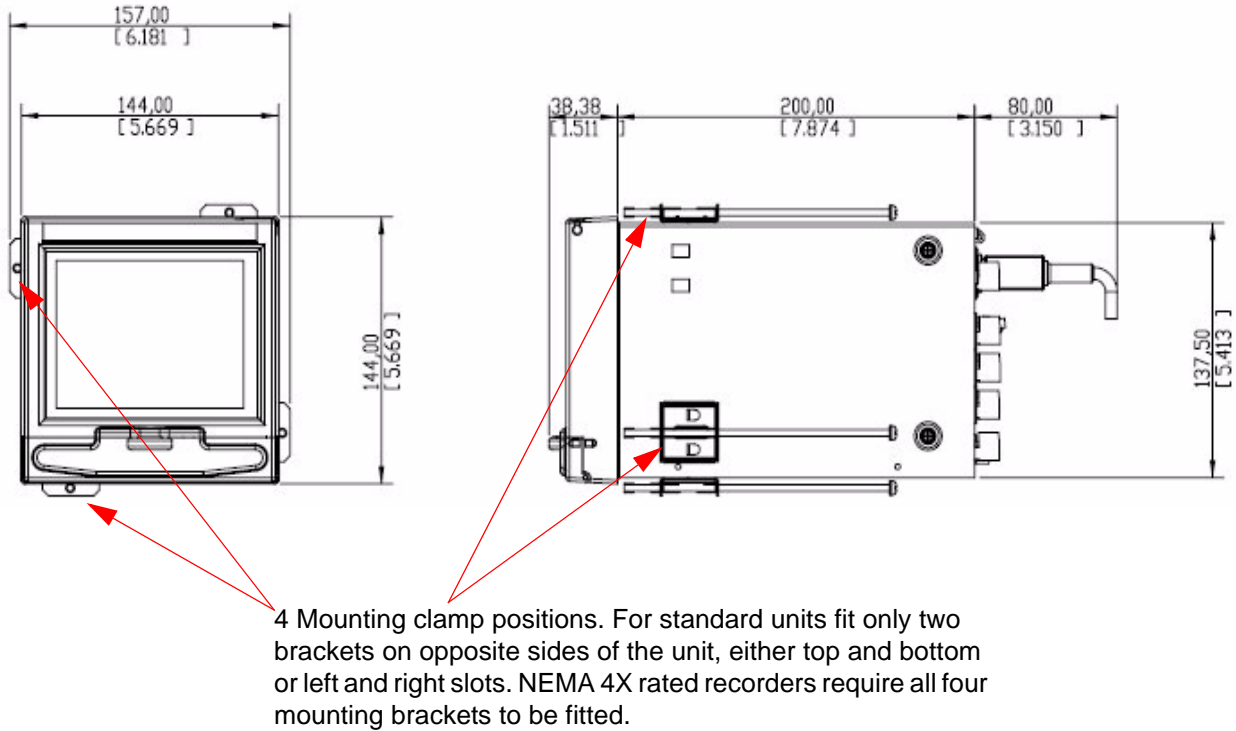

Figure 2.6 eZtrend GRrecorder dimensions

DR Graphic recorder Dimension details

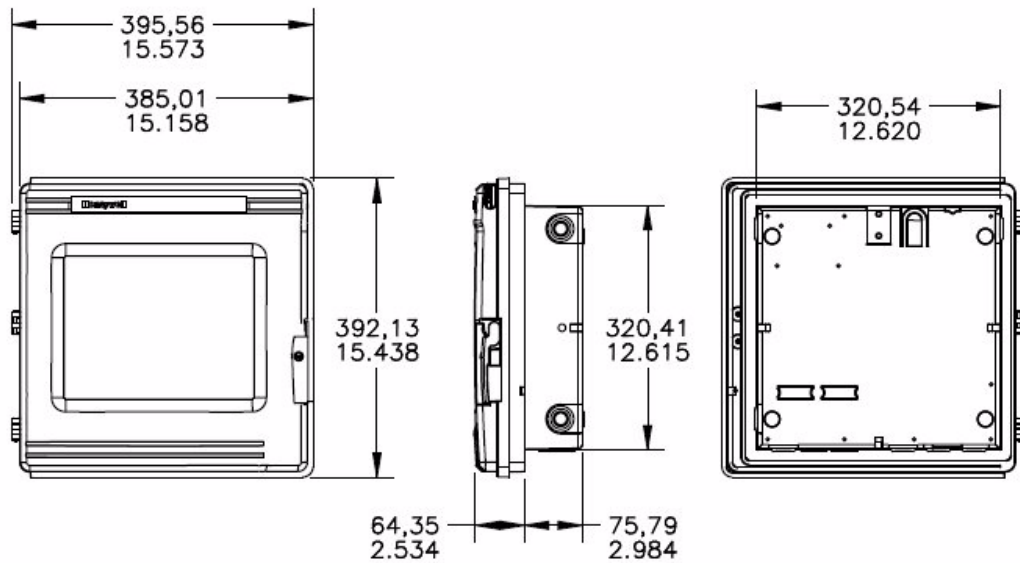

Figure 2.7 DR Graphic recorder dimensions

Mechanical Installation

Panel Mounting Clamp Installation

The **Minitrend GR**, **Multitrend GR** and the **eZtrend** recorders slide into the panel cut-out and are held in place by two or four panel clamps (6 clamps for **Minitrend GR** recorder with 45mm panel thickness). The panel clamps should be fitted on diagonally opposite sides of the unit and tightened against the rear of the panel using two fixing screws.

The mounting clamp assembly and fitting instructions differ slightly for the two recorders.

Minitrend GR and eZtrend GR *See Figure 2.6*

1. Insert the panel gasket onto the recorder so it goes between the back of the recorder bezel and the panel. From the front panel, place unit in the panel and push through the panel.
2. To loosen each clamp, unscrew the long screw to accommodate the panel thickness. Use either a Number 1 Phillips or Straight slot screw driver.
3. From behind the panel, the orientation of the clamp should be with the screw head towards the rear of the unit.
4. Take the first clamp and locate the two lugs on the clamp into the slots on the unit.
5. Take the second clamp and do the same but in the diagonal position to the opposite side. Repeat for all other clamps.
6. Tighten the screw using a Number 1 Phillips or Straight slot screw driver and the clamp will secure against the panel.



CAUTION

CONTROL UNIT DAMAGE

Do not over tighten mounting clamp screws.

Minitrend GR and **eZtrend GR** torque setting should be 0.5 - 0.75Nm/4.4 - 6.6lbf-in

Multitrend GR torque setting should be 0.5 - 0.70Nm/4.4 - 6.2lbf-in

Failure to comply with these instructions may result in product damage

Multitrend GR *See Figure 2.7*

1. Insert the panel gasket onto the recorder so it goes between the back of the recorder bezel and the panel. From the front panel, place unit in the panel and push through the panel.
2. To loosen each clamp, unscrew the long screw to accommodate the panel thickness. Use either a Number 1 Phillips or Straight slot screw driver.
3. From behind the panel, the orientation of the clamp should be with the screw head towards the rear of the unit.
4. Position the circular mounting boss in the hole on one side of the case with the lip of the boss inside the case. Ensure the front of the clamp is up against the panel.
5. Fix the second clamp on the opposite side of the unit.
6. Tighten the screw using a Number 1 Phillips or Straight slot screw driver and the clamp will secure against the panel.

Mechanical Installation

DR Graphic recorder *See Figure 2.8*

This section provides instructions for mounting the DR Graphic recorder using one of the following methods:

- Flush in a panel
- Flush in a panel for recorders with NEMA 4
- On the surface of a wall for panel

Choose the method that meets your mounting requirements. Use the associated dimension drawings for reference.

How to remove knockouts for conduits

Before you mount the recorder, remove the appropriate plugs in the bottom and/or sides of the recorder case for wire entry via 1/2" (12.7 mm) conduits. Refer to [Figure 2.8](#) for plug locations. To see recommended use of conduits for various types of wiring, refer to [Figure 2.12](#) and [Figure 2.13](#).

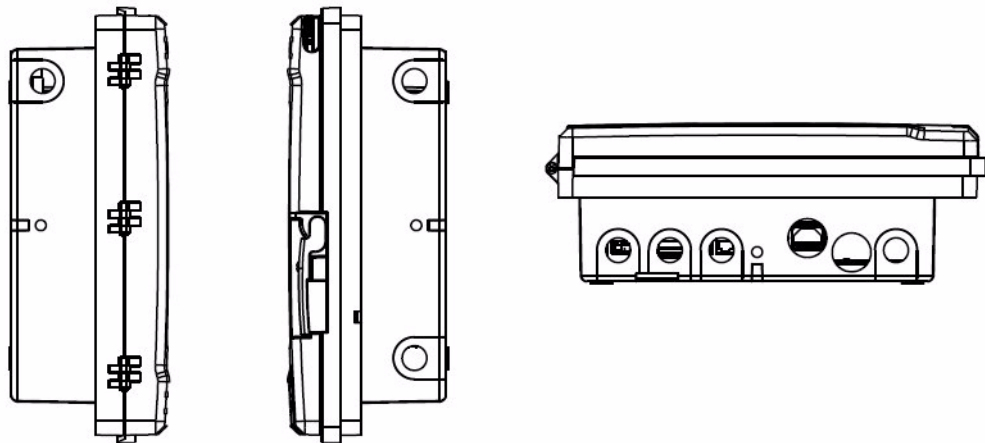

Figure 2.8 DR Graphic recorder dimensions

Mounting Flush in panel (new cut-out)

Procedure

1. At the appropriate location, make a square cutout in the panel. Cutout dimensions should be 12.7 ±0.060 inches by 12.7 ±0.060 inches (322.56 ±1.52 by 322.56 ±1.52 millimeters). [See Figure 2.9](#).
2. Orient the recorder case properly and slide it into the cutout from the front of the panel. Support the recorder as shown in Steps 3 and 4.
3. Refer to [Figure 2.9](#). From the back of the panel, attach a mounting bracket to each side of the recorder case using a 1/4-20 x 1/2 inch hex screw for each bracket (mounting hardware supplied with recorder). Leave the screws slightly loose so you can adjust the brackets.
4. While holding the recorder firmly against the panel, slide each bracket against the back of the panel and tighten the screws.

Mechanical Installation

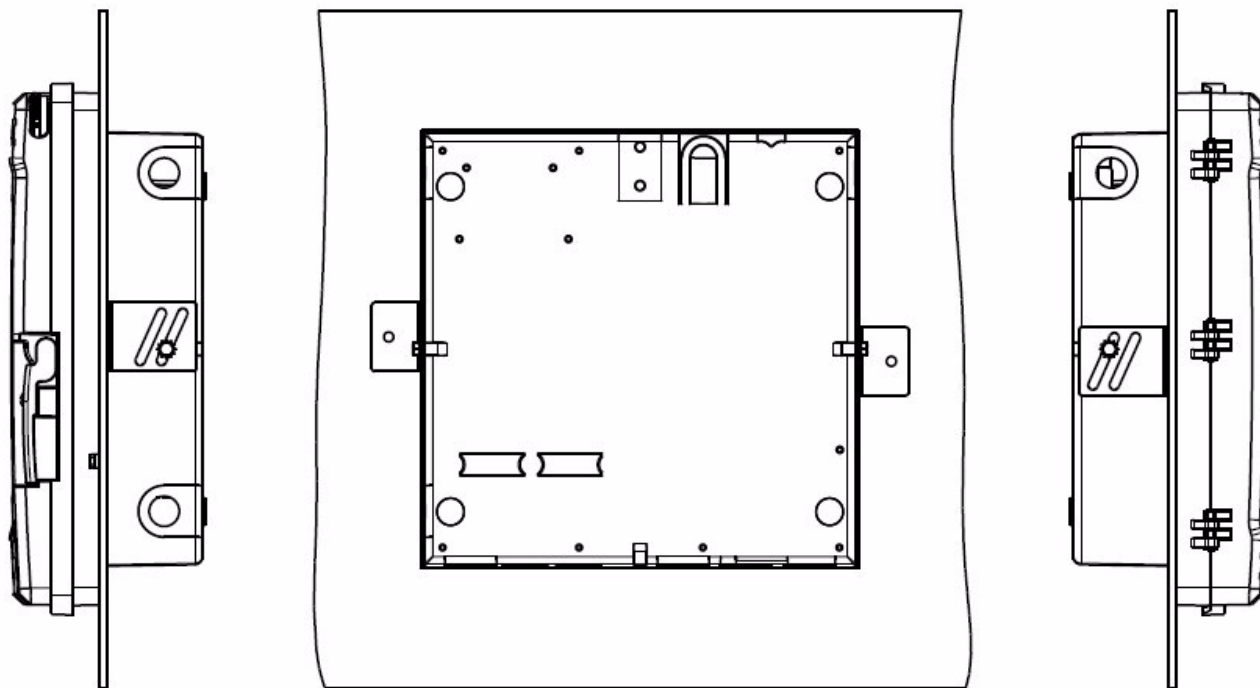
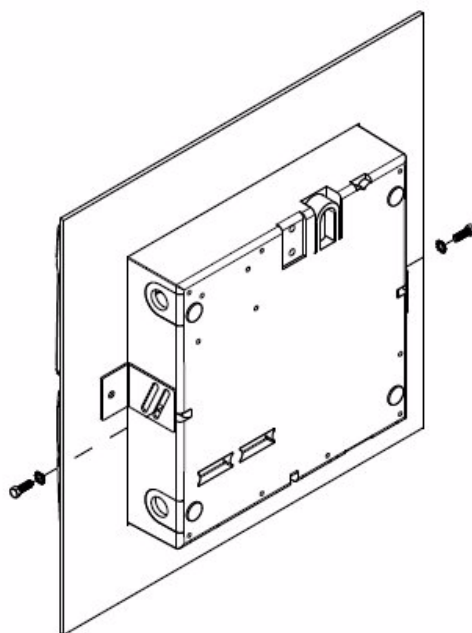

Figure 2.9 Flush Mounting in a panel cutout



NOTE: Mounting brackets and attaching hardware are included in kit 30755065-501

Mechanical Installation

Mounting Clamp Diagram

Figure 2.10 Minitrend GR Mounting Clamps

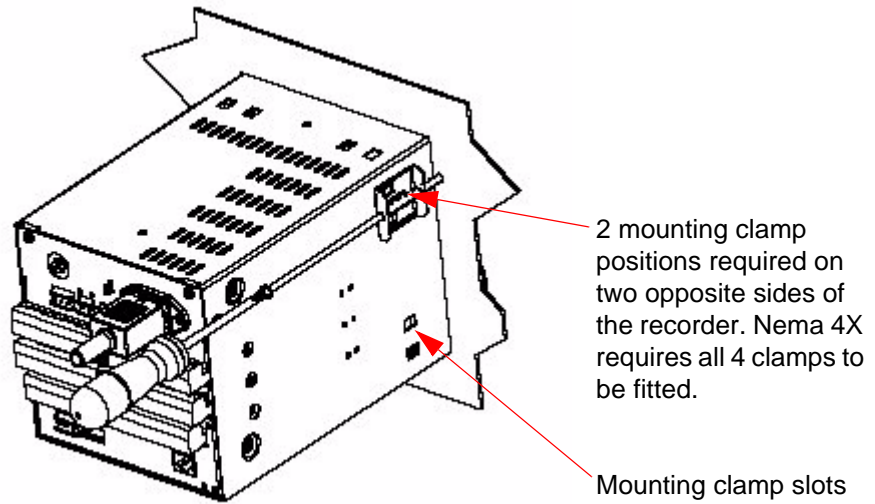
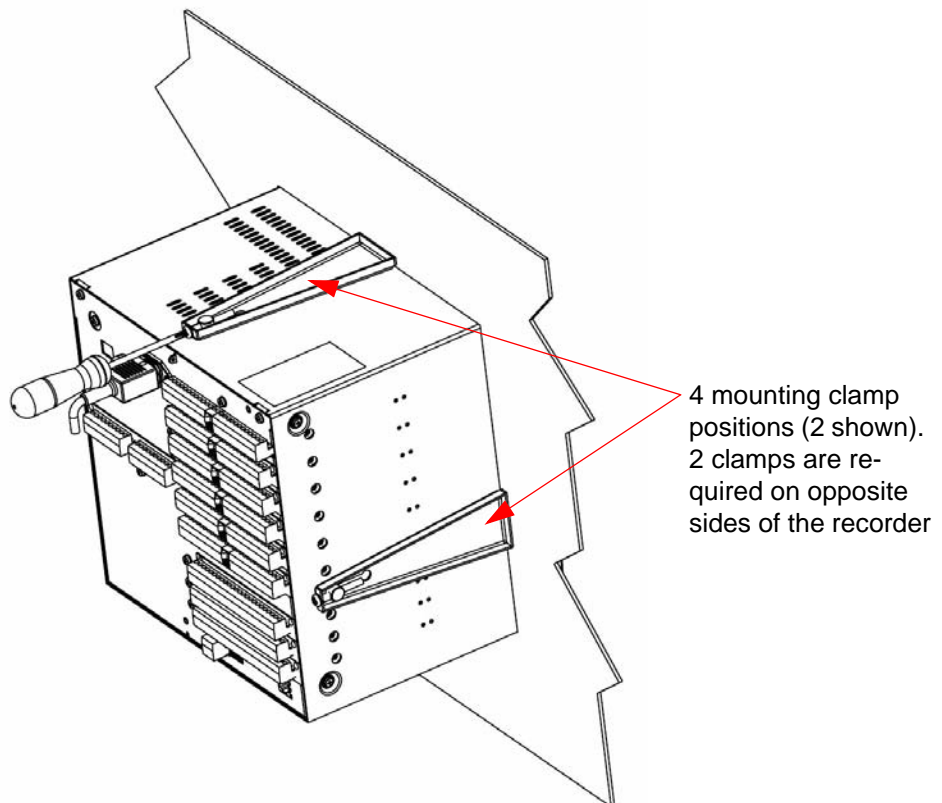

Figure 2.11 Multitrend GR Mounting Clamps



Mechanical Installation

Mounting Clamp Diagram for 45mm panel thickness

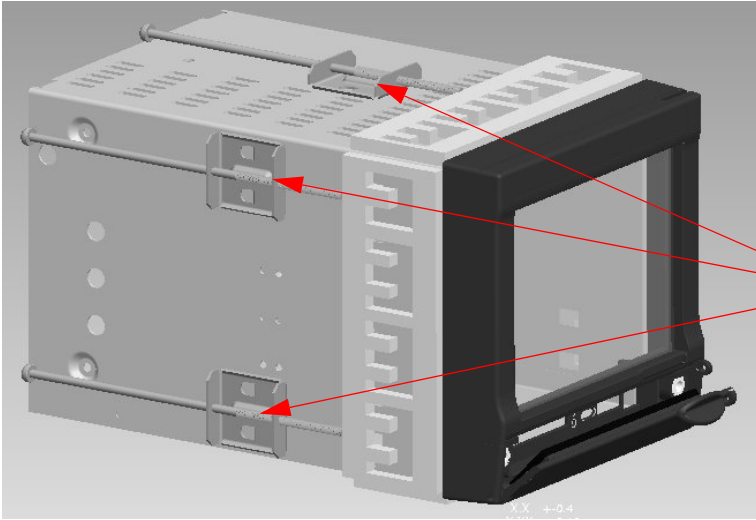

Figure 2.12 Minitrend GR - 45mm Mounting Clamps

6 mounting clamp positions (3 shown) for mounting in 45mm panel thickness. Mounting slots shown in [Figure 2.4](#). Only 2 mounting brackets need to be fixed, in opposite positions.

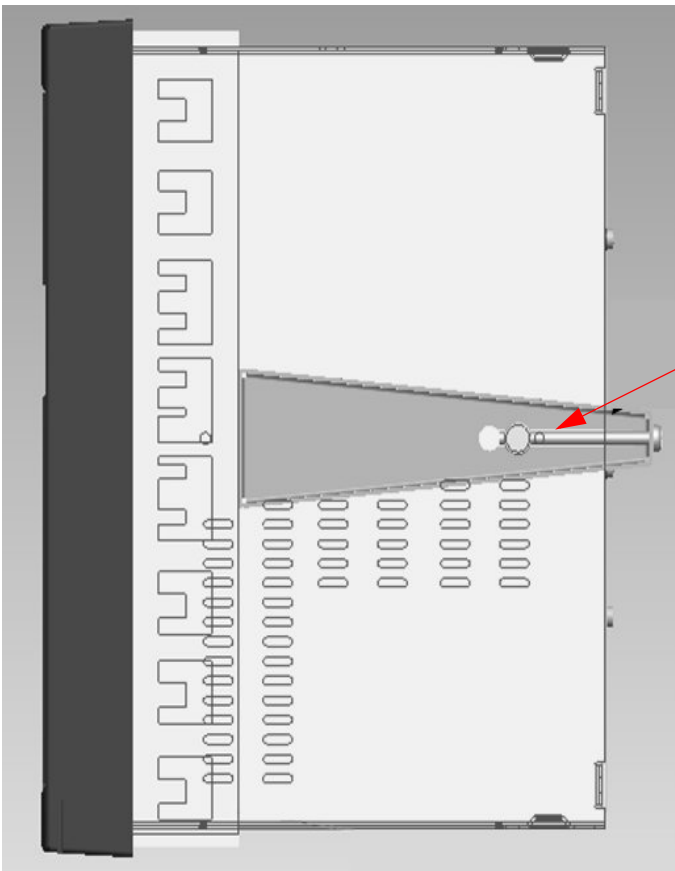

Figure 2.13 Multitrend GR - 45mm Mounting Clamps

4 mounting clamp positions (1 shown) for mounting in 45mm panel thickness on opposite sides of the unit. Mounting slots shown in [Figure 2.4](#). Both mounting clamps are required to be fitted

Mechanical Installation

Panel mounting recorder with NEMA4

Refer to [Figure 2.14](#) and follow the procedure below to panel mount your recorder if it has a NEMA4.

1. Place the panel gasket onto the rear flange of the recorder case.
2. Install four #8-32 screws on each of the three mounting brackets so the ends of the screw threads are flush with the face of the bracket.
NOTE: Screw heads to be flange side of brackets.
3. Insert the case with gasket into the panel opening.
4. Install one left hand and one right hand bracket with 1/4 x 3/8 long bolts and lockwashers on each side of the case.
NOTE: The notch on each bracket should be facing upward towards the top of the unit. Do not tighten the hex bolts at this time.
5. Install the remaining right hand bracket on the top with the 1/4 x 3/4 long bolt and lockwasher. Do not tighten the bolt at this time.
6. Place a screwdriver blade on the notch of each bracket and firmly tap so that each bracket firmly mates the case with gasket to the panel.
NOTE: Keep brackets parallel to case. Tighten the three 1/4 hex bolts to hold the brackets in place.
7. Start to tighten the #8-32 x 1/2 screws on the right side bracket. Alternate screws at opposite ends until all four screws have a minimum of 10 lb-in of torque applied. Do the same to both the left side and top brackets.
When completed all twelve screws should have a minimum of 10 lb-in of torque applied. This assures the case and panel gasket are adequately sealed against the panel.

Mechanical Installation

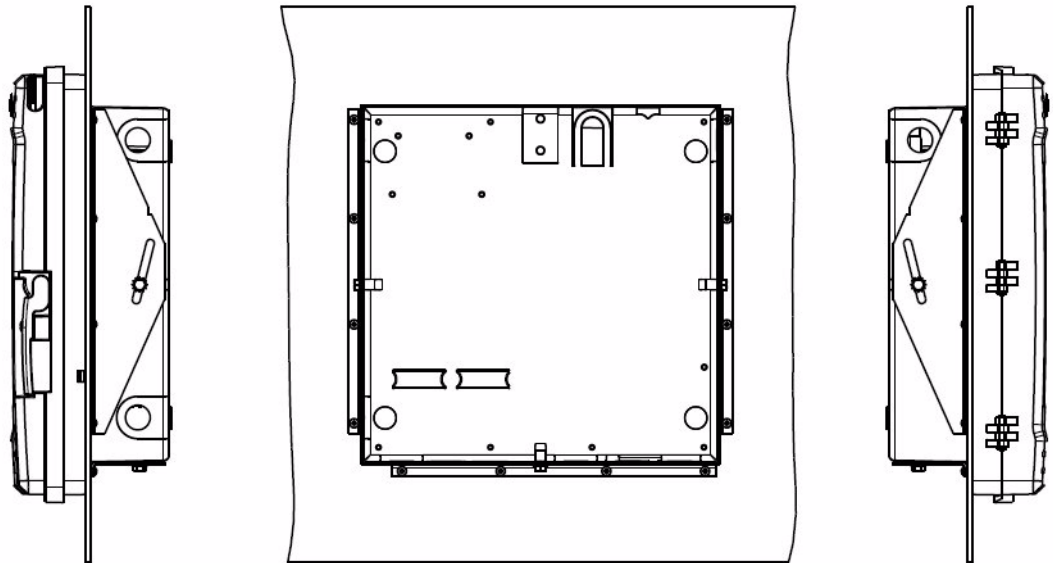
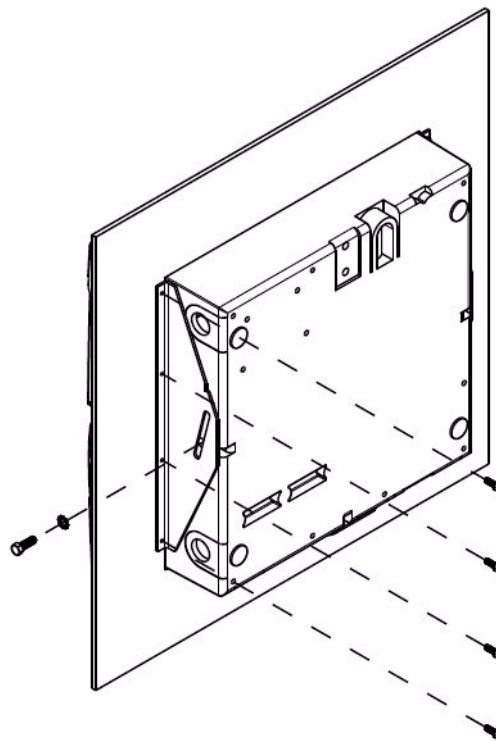

Figure 2.14 Panel Mounting with NEMA4



Mounting on Surface of panel or wall

Procedure

Refer to [Figure 2-15](#) and follow the procedure below to mount your recorder on a surface (panel or wall).

NOTE: Three (3) screws must be supplied by the user for attaching the mounting hardware (brackets and support hook) to panel or wall.

Using two flat-head 10-32 x 1/4-inch screws supplied with the recorder, fasten the support hook into the recess at the back of the recorder case as shown in [Figure 2-15](#).

1. Using 1/4-20 x 1/2-inch hex screws and lockwashers, attach a mounting bracket to each side of the case. Leave the screws slightly loose so as to permit some adjustments of the brackets.
2. On the panel, mark the locations for the three holes, as shown by the hole pattern in [Figure 2-15](#).
3. Using a drill of appropriate size for user-supplied screws, drill a hole in the front of the panel for the eye of the support hook.
4. Insert the screws for the support hook into the panel, allowing the screw head to protrude approximately 5/16-inch.
5. Hang the recorder support hook on the screw. Make sure that the locations for the other two holes (marked in Step 3) are correct. If not, make sure that the recorder is aligned vertically, and use the brackets as templates to mark the proper locations.
6. Remove the recorder from the panel and drill the other two holes.
7. Hang the recorder on the screw by the support hook and insert the other two user-supplied screws through the brackets into the panel. Tighten the two hex screws that attach the brackets to the case.

Mechanical Installation

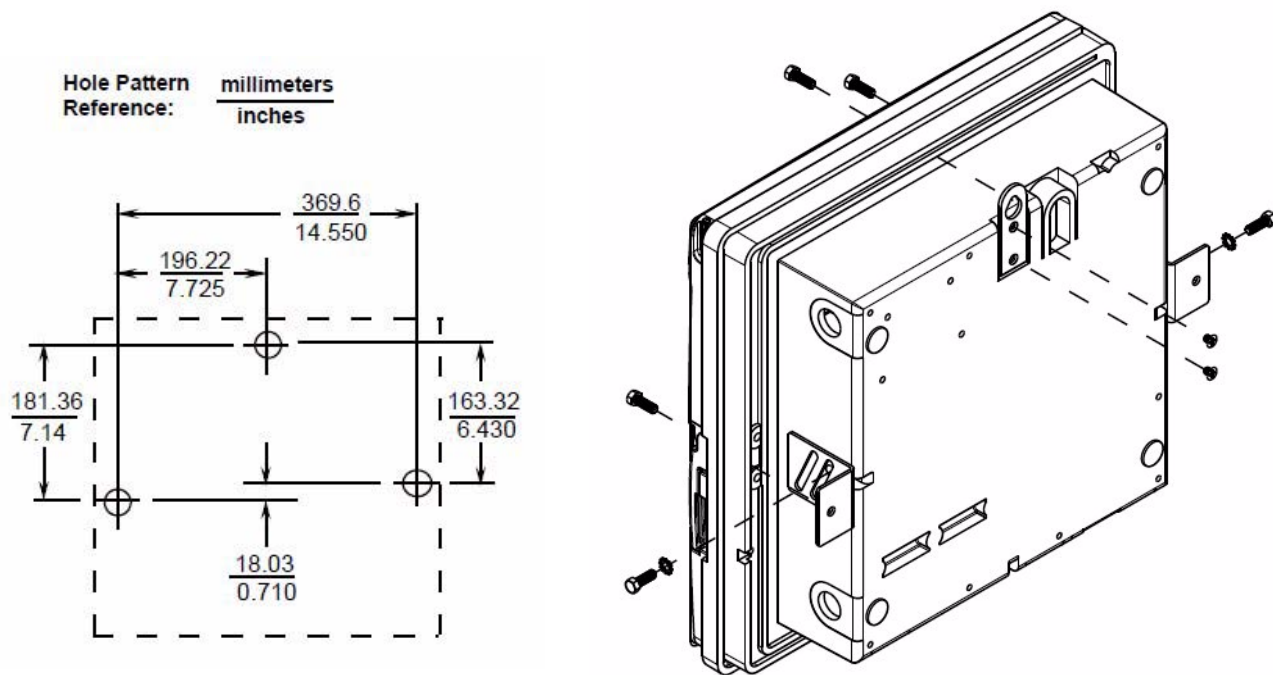

Figure 2.15 Surface Mount on wall or panel

Electrical Installation

Installation Category

- Installation category - Installation category II, Pollution degree 2
- Follow National and local electrical codes for installation in a Class 1, Div.2 area.

For voltage, frequency and power refer to the appropriate Specification sheet: [See “Section 12: Technical Data & Specifications” on page 303.](#)

Fuses

There is a fuse situated on the DC input version power supply, type 2A time-delay, this can be replaced by the user. Replacement of fuses should be carried out by qualified service personnel.

If the fuse should blow again there is probably a problem elsewhere within the unit and the recorder should be returned for inspection to your authorised **Honeywell** distributor or **Honeywell** Service department.

Cables

To fully comply with the requirements of the CE Mark, all cables connected to the rear of the unit should use screened cable terminated at both ends. A low impedance earth cable (<50 mΩ) **must** be connected to the earthing stud on the rear of the recorder, to ensure that the recorder is always earthed.

Before performing any installation please read the section on [“Safety” on page 2](#) and [“Warnings and Safety Precautions” on page 3.](#)

All connections to the unit are made via the rear panel, the layout of which is shown in [page 24](#)

Note: The **eZtrend GR** Analogue Input card (Slot A). Cable screen must be well connected to the recorder case using a low impedance bond. Also avoid use of a length of wire between the cable screen and the recorder case.

Signal Wiring



WARNING

ENSURE SAFETY EARTH CONNECTION

Always ensure the unit is connected to safety earth when connecting to an AC or DC supply.

Failure to comply with these instructions could result in death or serious injury.

Your recorder is intended for panel-mount use, and only the front face is intended to be exposed to the operator. Disconnection from the supply **MUST** be made possible by means of a switch, circuit breaker or other means of supply isolation.

The disconnection device must be included in the panel installation, clearly marked, in close proximity to the recorder, and within easy reach of the operator. The protective earth terminal must remain connected (even if the recorder is isolated from the mains supply) if any of the analogue or relay terminals are connected to hazardous voltage.



CAUTION

UNIT DAMAGE CONTROL

To protect against component failures the user should fit an external fuse for the DC input power supply. The value should be 4A, time delay, high breaking capacity, minimum 60Vdc.rated.

Failure to comply with these instructions may result in product damage



WARNING

HAZARDOUS VOLTAGES

When using the recorder as portable equipment the optional rear cover must be fitted when hazardous voltages are connected.

Failure to comply with these instructions could result in death or serious injury.

AC Power

AC supply is connected via the standard configuration IEC chassis plug on the power supply, 100 - 240 Vac, 50-60 Hz (40W **Minitrend GR**, **eZtrend GR** and 50VA **DR Graphic** and 60W **Multitrend GR**). Absolute limits 90V-132Vac (110V) and 180V-264Vac (240V).

AC/DC Power Supply

For the **Minitrend GR** the supply range is 12-30V DC (absolute limits are 12V to 30V DC). The **DR Graphic** and **Multitrend GR** the supply range is 24V DC +/- 10% (absolute limits are 20V to 55V DC), the AC range is 20 to 30V AC. The **Minitrend GR** and the **eZtrend GR** also has an 18V option with supply range 12VDC -30VDC / 12VAC -20VAC.

DC power rating are as follows **Minitrend GR** and **eZtrend GR**: 40W, **Multitrend GR**: 60W, **DR Graphic**: 40W.

Power to the D.C.variant is connected via a rectangular 3-way connector as identified in [page 24](#) for the **Minitrend GR** and [page 24](#) for the **Multitrend GR** and [page 26](#) for the **DR Graphic**.

Note: Inrush Current = 75A max(High Line, Cold Start) for all recorders.

Electrical Installation

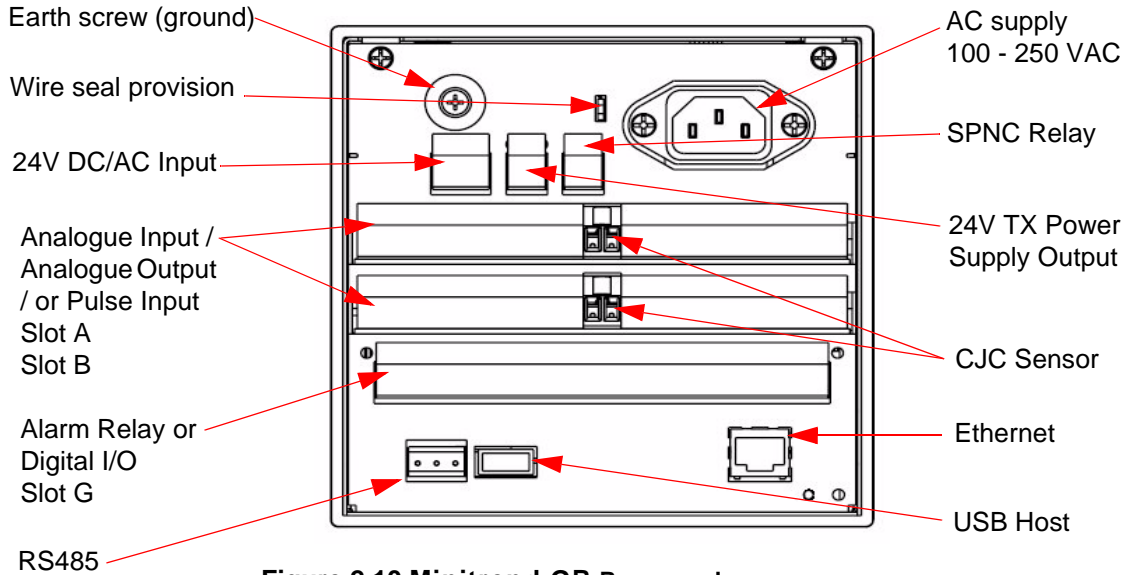

Figure 2.10 Minitrend GR Rear panel

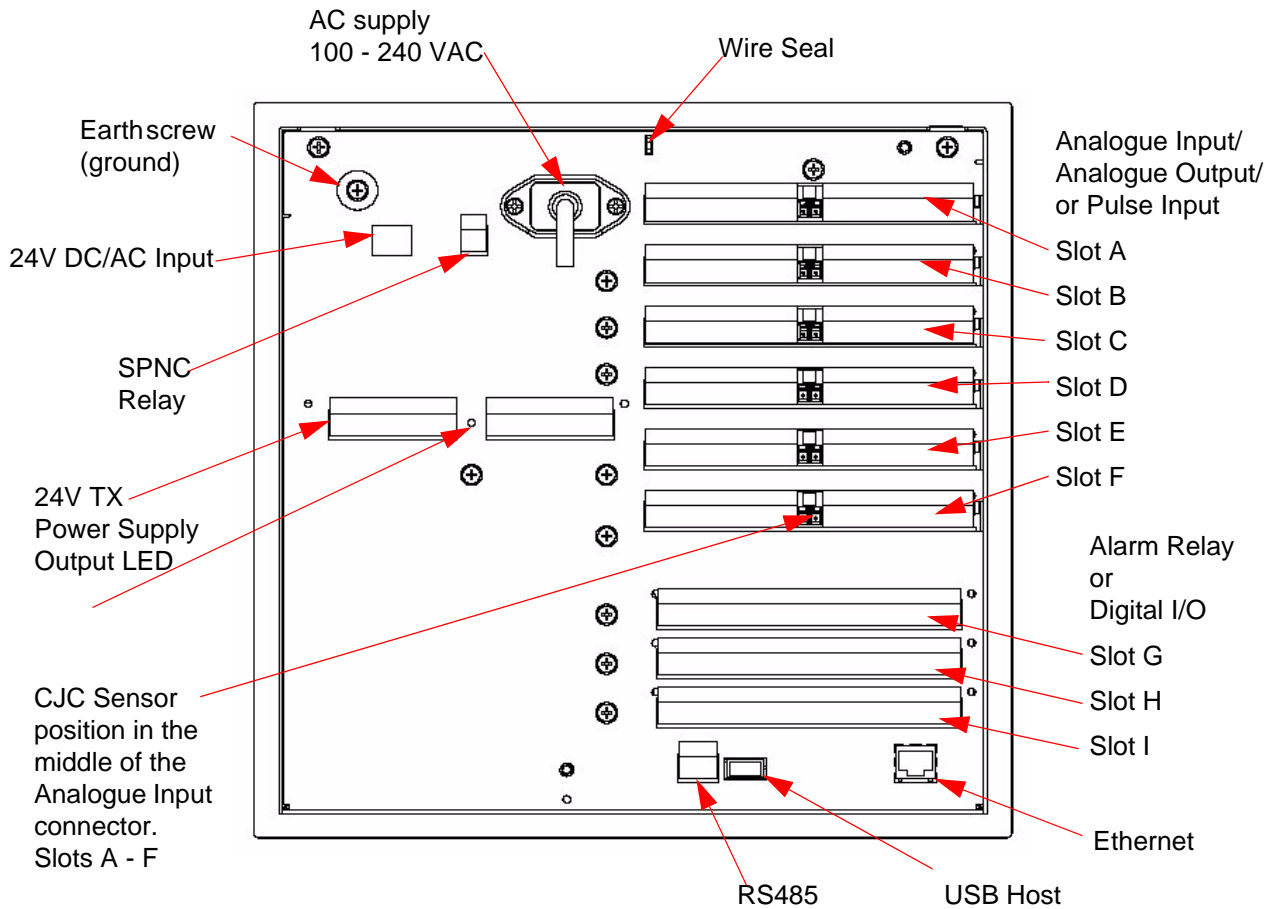

Figure 2.11 Multitrend GR Rear panel

Electrical Installation

Card and Slot positions

Table 2.1 : Card priority positions

| Cards | Minitrend GR | Multitrend GR | eZtrend GR | DR Graphic |
|------------------------------------|-------------------------|--------------------------|-----------------------|-------------------|
| Analogue Input card | A, B | A, B, C, D, E, F | A*, B (option) | A, B |
| Analogue Output card | B | E, F | - | B |
| Pulse Input card | A, B | A, B, C, D, E, F | - | A, B |
| Alarm Relay or Digital I/O card | G | G, H, I | G | B |

DR Graphic card positions

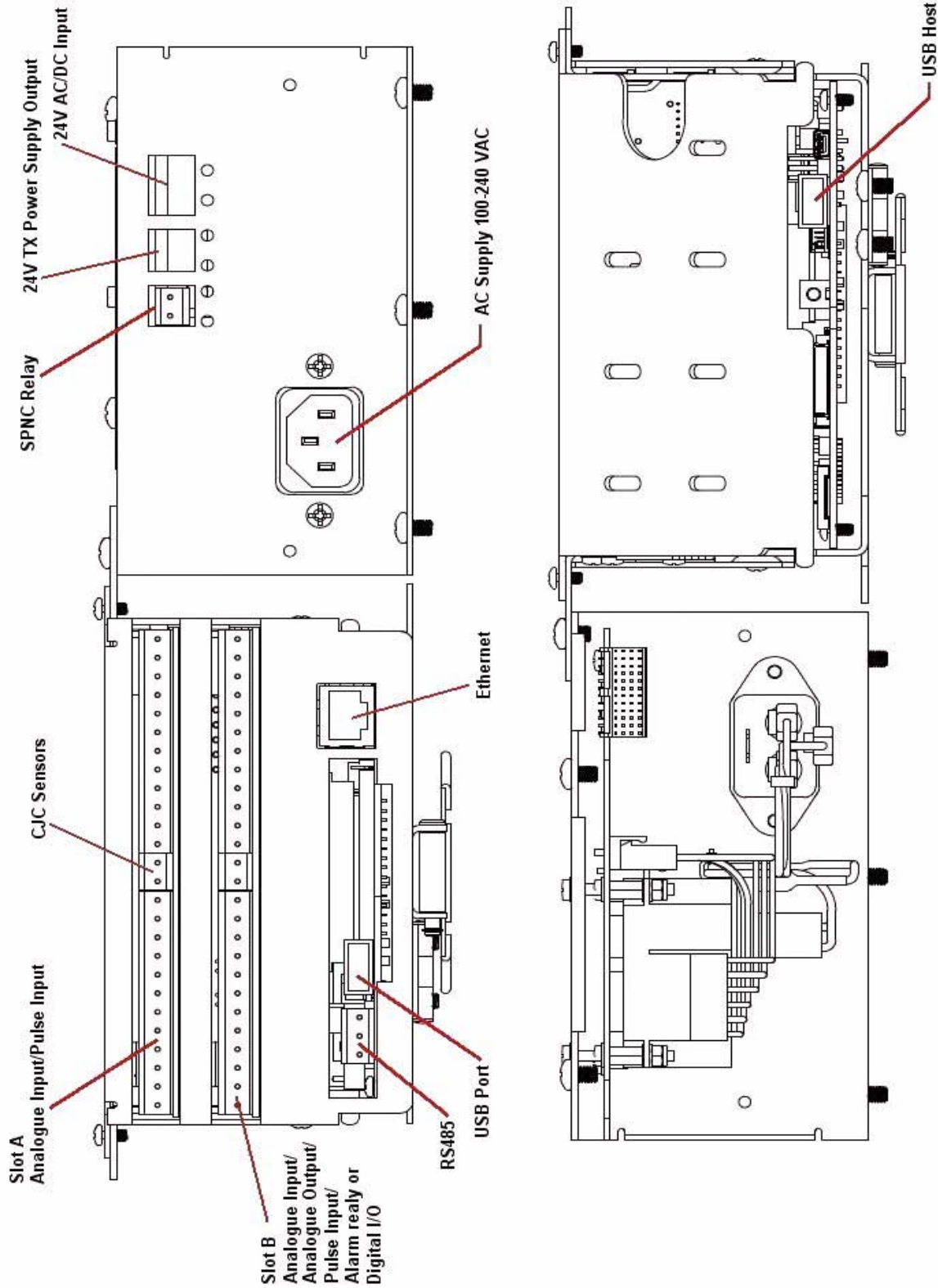

Figure 2.12 DR Graphic slot positions and connections

Electrical Installation

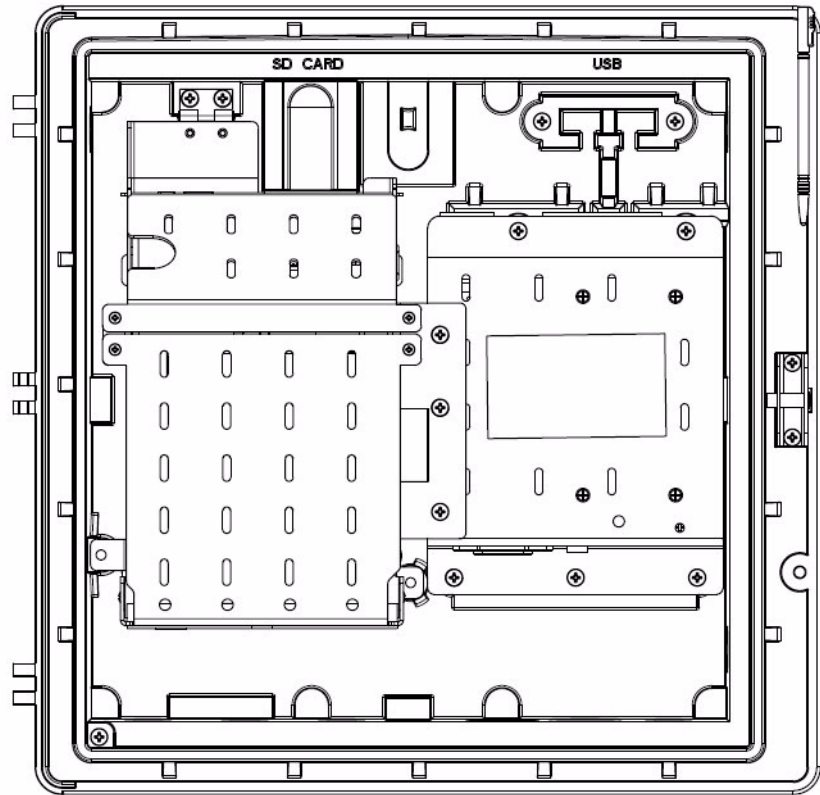

Figure 2.13 DR Graphic Electrical connections

DR Graphic cards; selection jumper table

Table 2.2 :

| | | |
|--------|-------------|---------------------|
| Slot B | AI/AO/Pulse | J8 & J9: Link 1 & 2 |
| | Alarm/DI/DO | J8 & J9: Link 2 & 3 |

NOTE: Do not disturb J4 & J5 jumpers in positions 1 & 2 for Slot A. These are for future provision.

Electrical Installation

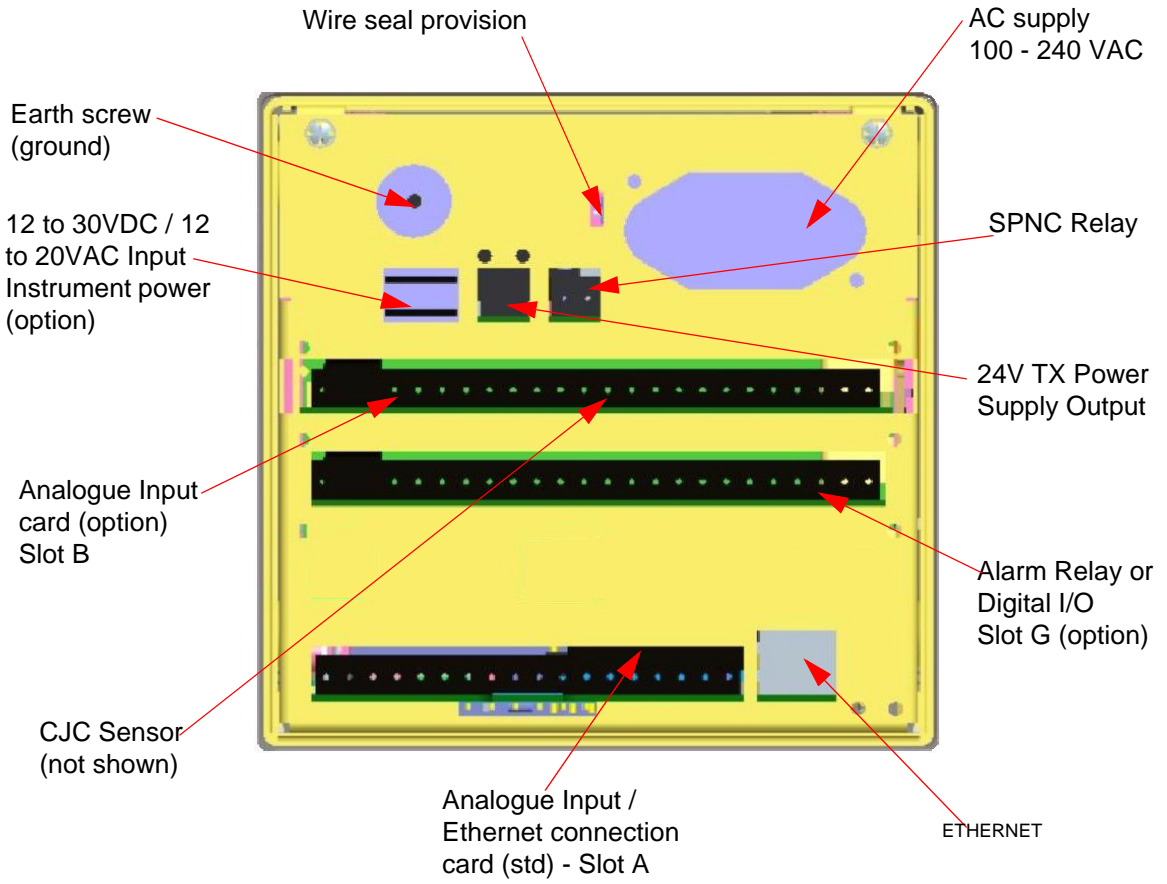

Figure 2.14 eZtrend GR Rear panel

Analogue Input Card

Each **Analogue Input card** has up to 8 input channels for the **Minitrend GR** and the **Multitrend GR** and up to 6 channels for the **eZtrend GR**. Connections are made via 2 x 12-way screw terminal plugs that fit into a PCB header on the rear of the unit. The 2-way CJC sensor should remain fitted in the central 2-way header.

The **Minitrend GR** can have two analogue input cards fitted giving up to 16 input channels (2 x 8 channel cards). The slot positions are A & B, these are identified on the rear panel on the back of the unit. Either slot can be used, it is recommended that slot A is used if only one card is fitted.

The **Multitrend GR** can have up to 6 analogue input cards fitted, up to 48 input channels. The slot positions A, B, C, D, E or F; these are identified on the rear panel. PC boards are fitted in order, slot "A" starts from the top.

The **eZtrend GR** can use this card as an additional Analogue Input card fitted in Slot B, providing up to 6 more channels. This card would be used after using the 3 or 6 channel standard **eZtrend GR** Analogue Input card which is fitted in Slot A, see "[eZtrend GR Analogue Input \(Standard\) card](#)" on page 32. The **DR Graphic Recorders** can have two analogue input cards fitted giving up to 16 input channels (2 x 8 channel cards). The slot positions are A & B, these are identified on the IO card chassis inside the unit. Either slot can be used, it is recommended that slot A is used if only one card is fitted.

Ensure to connect the jumpers on **DR Graphic** backplane card as per **DR Graphic** Cards Selection Jumper Table on [page 27](#) before installing the AI cards. See "[eZtrend GR Analogue Input \(Standard\) card](#)" on page 32.

To fit this option card into the **eZtrend GR** recorder you will require an expansion card to interface to the recorder.

WARNING

HAZARDOUS VOLTAGES

Insulation from channel to channel: Normally a channel can be safely connected to a hazardous voltage up to 300V AC common mode* with respect to earth. However, where a channel is connected to a safety low voltage circuit, an immediately adjacent channel must be adequately insulated from hazardous voltages between 150V AC and 300V AC max. This insulation should comprise of at least 1.5mm air gap, or a barrier rated greater than 1400V AC. This is to ensure that protection of the safety low voltage circuit is fully maintained.

*Common Mode voltage is a voltage applied between the whole channel and earth, not between pins on a channel. 300V AC is permitted at Measurement Category CAT II (Overvoltage Category II)

Failure to comply with these instructions could result in death or serious injury.

NOTICE

For 12 and 24-way connectors; torque setting 0.4 Nm/3.5lbf-in. Do not over tighten. Recommended wire size for termination connector is 22-12 AWG (American Wire gauge) equivalent to 22-14 SWG (Standard Wire Gauge). AWG metric 0.6426-2.052mm in diameter or SWG metric 0.71 - 2.03mm in diameter.

Electrical Installation

Rear Covers

Optional rear covers are available for these products (except for the **DR Graphic recoder** which does not require a rear cover) and it is recommended to use the rear cover to protect the wiring and to minimize external effects that could impact the performance of the CJC. For the rear cover part number, see [“Section 10: Spares List” on page 281.](#)

Analogue Input Channel Numbers

Analogue Input cards are either 4, 6 or 8 channels with a full length connector taking up 8 channels even if only 4 or 6 are operational.

Table 2.3 :

| Minitrend GR Multitrend GR and DR Graphic Analogue Input card | | | | | | |
|---|--------|---------|----------|----------|----------|----------|
| Card Position | Slot A | Slot B | Slot C | Slot D | Slot E | Slot F |
| Channel number | 1 to 8 | 9 to 16 | 17 to 24 | 25 to 32 | 33 to 40 | 41 to 48 |

Table 2.4 : eZtrend GR Analogue Input cards

| Card | 3 CH. | 6 CH. | 9 CH. | 12 CH. |
|------|-------|-------|-------|--------|
| A | 1-3 | 1-6 | 1-3 | 1-6 |
| B | | | 9-14 | 9-14 |

Analogue Input Connection Details

Current Input

For Current (mA) Input fit a 10 Ω resistor across the + and - pins of the 12-way mating half analogue connector. [Figure 2.15](#) shows a 10 Ω ($\pm 0.1\%$) resistor fitted to channel 5 for a current (mA) input. **Thermocouples**

Ensure polarity of thermocouple is correct.

Resistance Thermometers

If using 2 wire R/T the + and - terminals must be linked together. See [“Figure 2.16 Input signal wiring” on page 31.](#)

Analogue Input Signal Wiring



CAUTION

CONTROL UNIT DAMAGE

Do not apply a hazardous live voltage between + and - pins within a channel. (eg. 60V maximum on voltage ranges, 5V maximum on millivolts ranges). Do not apply a voltage above 1.2V to the * pin.

Failure to comply with these instructions may result in product damage

Electrical Installation

Figure 2.15 Analogue Input connector

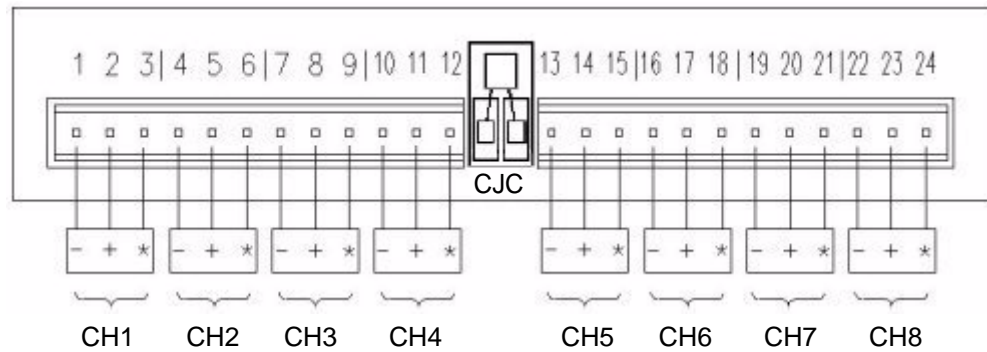

This Analogue Input card can be used as an option to add up to 6 more Analogue Input channels for the **eZtrend GR** recorder. This will fit into Slot B and will display as channel numbers 9 to 14. The standard fit Analogue Input card is fitted in slot A with up to 6 channels (channels numbers 1 to 6).

To fit this option card into the **eZtrend GR** recorder you will require an expansion card to interface to the recorder.

Figure 2.16 Input signal wiring

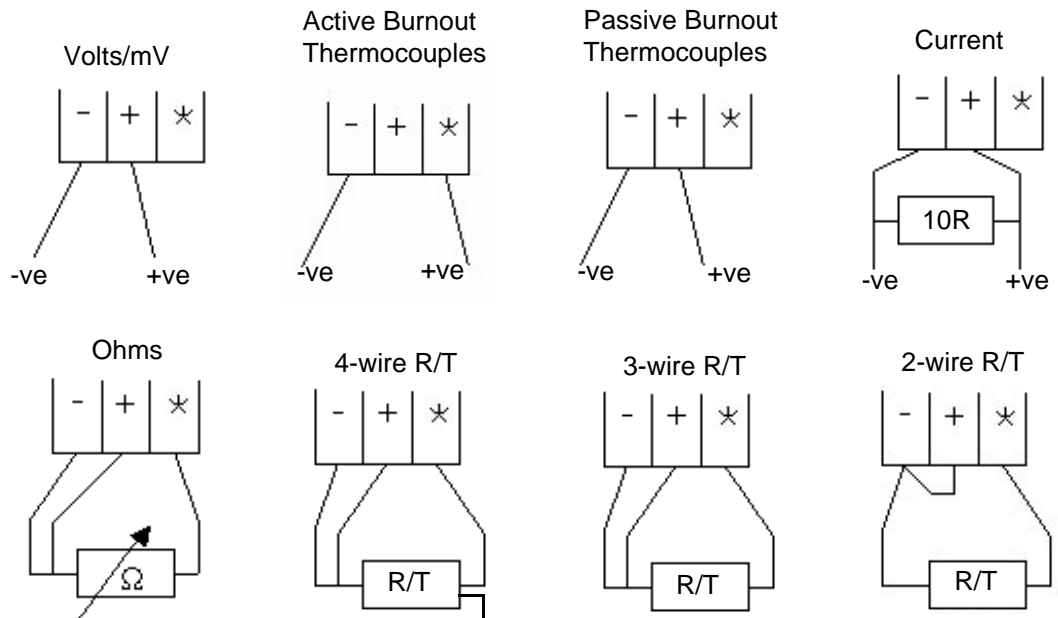

Recorder setup will be required if wiring changes are made for Active Burnout Thermocouples. [See *"Thermocouple Wiring Changes."* on page 76.](#)

Electrical Installation

Thermocouple Active Burnout status can be viewed in the *Main Menu > Status > Diagnostics > Analogue Input screen, Input column*. The Health Watch/Maintenance firmware option must be active to access the Maintenance and Diagnostic buttons. See [“Diagnostics” on page 200](#).

For the **eZtrend GR** recorder Active Burnout is not available. Ohms measurements must have the link between positive (+) and negative (-).

CJC Connectors

The CJC connector resides between channel 4 and channel 5 on the Analogue Input card. For information on connecting the CJC sensor, see [“Figure 2.15 Analogue Input connector” on page 31](#).

For the **eZtrend GR** recorder this is available on the Analogue Input card (option).

eZtrend GR Analogue Input (Standard) card

The **eZtrend GR** is fitted with a standard Analogue Input card in Slot A, with up to 6 channels. The card is also fitted with an Ethernet port as standard. Connection is made via 1 x 18-way screw terminal plugs that fit into a PCB header on the rear of the unit. To fit up to a further 6 analogue input channels, see [“Analogue Input Card” on page 29](#)

Figure 2.17 eZtrend GR Analogue Input card (std) - Slot A

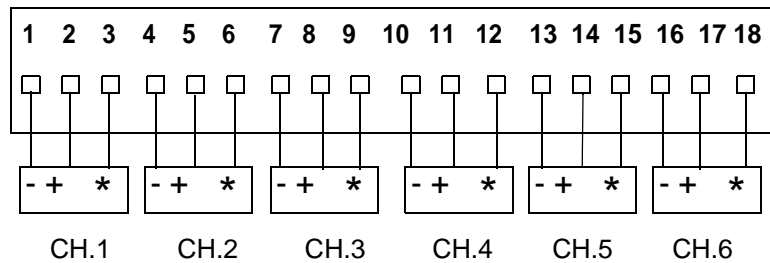

WARNING

HAZARDOUS VOLTAGES

Insulation from channel to channel: Normally a channel can be safely connected to a hazardous voltage up to 150V AC common mode* with respect to earth. However, where a channel is connected to a safety low voltage circuit (i.e. is accessible for operators to touch), any channel within the same 'input bank' must be limited at all times to a maximum of 55Vac or 140Vdc**. This is to ensure that protection of the safety low voltage circuit is fully maintained.

The inputs are divided into two banks: inputs 1 to 3 are one bank, and inputs 4 to 6 (if fitted) are another bank. A voltage of up to 150V AC common mode can be applied on one bank as long as any safety low voltage circuits are on the other bank. The recorder is protected against accidental connection of a voltage up to 240V AC common mode which might occur as a temporary fault condition, provided there are no safety low voltage circuits connected to the same input bank as the channel with the fault.

*Common Mode voltage is a voltage applied between the whole channel and earth, not between pins on a channel.

** this reduces to 33Vrms or 70Vdc if any channel within the input bank is configured as an ohms or R/T measurement.

Failure to comply with these instructions could result in death or serious injury.

CAUTION

CONTROL UNIT DAMAGE

Do not apply a hazardous live voltage between + and - pins within a channel (e.g. 60V maximum on voltage ranges, 5V maximum on millivolts ranges).

The * pin should be connected only as part of ohms or R/T measurements. Ohms and R/T measurements share a common connection (* pin) with all channels in the same bank (the inputs are divided into two banks: inputs 1 to 3 are one bank, and inputs 4 to 6, if fitted, are another bank). To avoid damage, ensure that a channel selected as ohms or R/T remains floating, i.e. the sensor is not connected to any external voltage.

Alternatively, if an ohms or R/T sensor must be biased to an external voltage, ensure that the other two channels within the same input bank are floating or are biased to the same voltage (i.e. - inputs of all three channels connected to the same voltage).

Failure to comply with these instructions may result in product damage

Analogue Output Card

Not available on the **eZtrend GR** recorder.

The **Analogue Output card** connections are made via 1 x 12-way screw terminal plug that fits into a PCB header on the rear of the unit.

The Analogue Output card position for the **Minitrend GR, Multitrend GR and DR Graphic** shown in [Table 2.1 on page 25](#).



WARNING

HAZARDOUS VOLTAGES

Insulation from channel to channel: Normally a channel can be safely connected to a hazardous voltage up to 300V AC common mode* with respect to earth. However, where a channel is connected to a safety low voltage circuit, an immediately adjacent channel must be adequately insulated from hazardous voltages between 150V AC and 300V AC max. This insulation should comprise of at least 1.5mm air gap, or a barrier rated greater than 1400V AC. This is to ensure that protection of the safety low voltage circuit is fully maintained.

*Common Mode voltage is a voltage applied between the whole channel and earth, not between pins on a channel. 300V AC is permitted at Measurement Category CAT II (Overvoltage Category II)

Failure to comply with these instructions could result in death or serious injury.

Electrical Installation

Analogue Output Channel Numbers

The Analogue Output cards are either 2 or 4 channels using a connector that only takes up half the length of the connector slot. Looking from the rear of the unit the Analogue Out connector is on the left of the Analogue slot with a blanking plate on the right.

Table 2.5 :

| Analogue Output card | | | |
|----------------------|---------|----------|----------|
| Card Position | Slot B | Slot E | Slot F |
| Channel number | 9 to 12 | 33 to 36 | 41 to 44 |

Analogue Output Connection Details

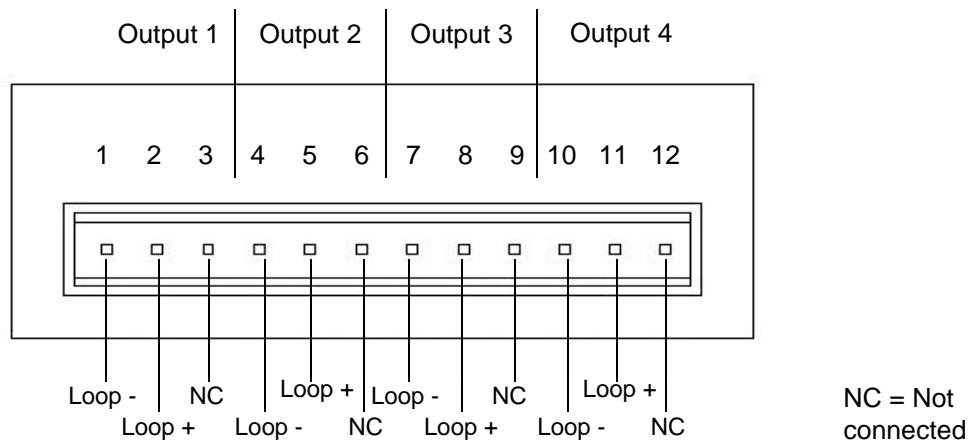

Pulse Input Card

The **Pulse Input card** connections are made via 1 x 12-way screw terminal plugs that fits into a PCB header on the rear of the unit.

The Pulse Input card position for the **Minitrend GR** and for the **Multitrend GR** and **DR Graphic** are shown in [Table 2.1 on page 25](#)

The Pulse Input card is not available on the **eZtrend GR** recorder, however, the 8 Digital I/O option card has 4 channels that can be set as pulse inputs (channels 1 to 4). The operating frequency for pulse inputs on the Digital I/O card is 1kHz max.

Input: Low < 1V, High >4V to <50V DC (8V to 50V p-p AC) or Volt free input: Low = short circuit, High = open circuit.

WARNING

HAZARDOUS VOLTAGES

Insulation from channel to channel: Normally a channel can be safely connected to a hazardous voltage up to 300V AC common mode* with respect to earth. However, where a channel is connected to a safety low voltage circuit, an immediately adjacent channel must be adequately insulated from hazardous voltages between 150V AC and 300V AC max. This insulation should comprise of at least 1.5mm air gap, or a barrier rated greater than 1400V AC. This is to ensure that protection of the safety low voltage circuit is fully maintained.

*Common Mode” voltage is a voltage applied between the whole channel and earth, not between pins on a channel. 300V AC is permitted at Measurement Category CAT II (Overvoltage Category II)

Failure to comply with these instructions could result in death or serious injury.

Pulse Input Channel Numbers

The Pulse Input card has channels using a connector that only takes up half the length of the connector slot. Looking from the rear of the unit the Pulse Input connector is on the right of the slot with a blanking plate on the left.

Table 2.6 :

| Pulse Input card | | | | | | |
|-------------------------|--------|---------|----------|----------|----------|----------|
| Card Position | Slot A | Slot B | Slot C | Slot D | Slot E | Slot F |
| Channel number | 1 to 4 | 9 to 12 | 17 to 20 | 25 to 28 | 33 to 36 | 41 to 44 |

Pulse Input Connection Details

Do not connect anything to terminals marked **NC** (Not Connected). For Frequency and Voltage levels see [“Specification Tables” on page 307](#).

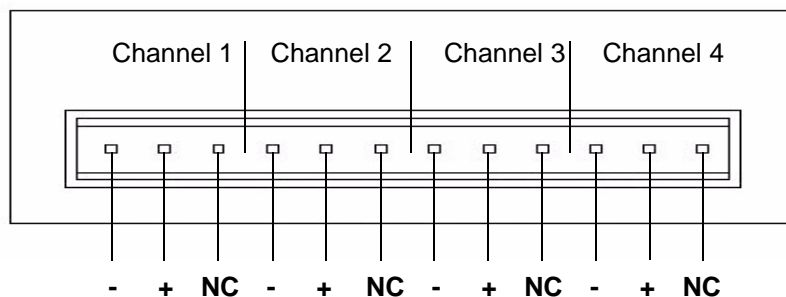

Transmitter Power Supply Card

The **Minitrend GR** and the **eZtrend GR Transmitter power supply** option is 24V DC 200 mA and is fitted to the power supply card within the unit. Connection is made via a 2-way connector at the rear of the unit, the mating half is supplied with this option. For connector position see [page 24](#). The 24V transmitter power supply is not isolated from the recorder, and is not referenced to ground.

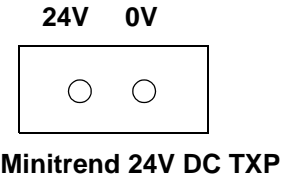

The **Multitrend GR Transmitter power supply** option is 24V DC 1 A and is fitted below the power supply card within the unit. Connection is made via two 10-way connectors, see [page 24](#), mating halves supplied with this option. The **Multitrend GR** transmitter power supply is isolated from the recorder.

A red LED light will illuminate when there is voltage on the connectors. The LED is situated between the two connectors at the back of the unit. See [page 24](#).

Recommended wire size for termination connector 22-12 AWG (22-14 SWG).

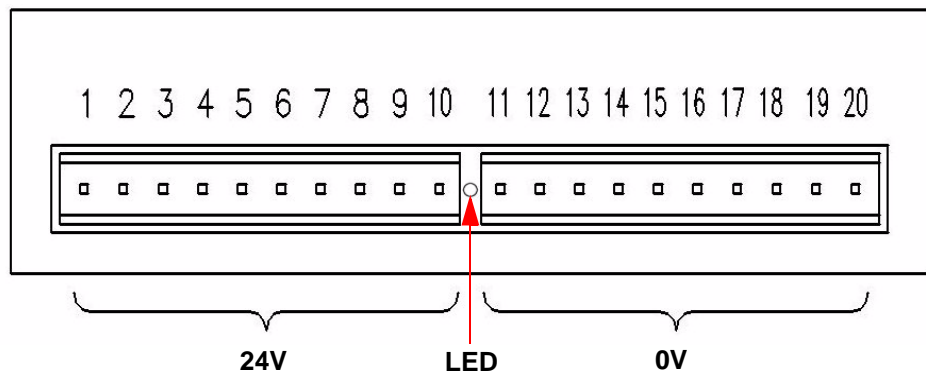

Figure 2.16 Transmitter Power Supply card for the **Multitrend GR** recorder

Alarm Relay Cards & Digital Input/Output Cards

The **Alarm Relay Cards** and the **Digital Input/Output Cards** are both options available for the **Minitrend GR**, **Multitrend GR**, **eZtrend GR** and the **DR Graphic** recorders.

To fit these option cards into the **eZtrend GR** recorder it requires an expansion card to interface to the recorder.

All Alarm Relay card outputs provide 240V AC isolation channel to channel and channel to recorder. Digital Input/Outputs will provide isolation to 100V AC test voltage (not for mains connection).

All digital inputs have volt free contacts, and are sampled at 10Hz max.

The **Minitrend GR**, **eZtrend GR** and the **DR Graphic** recorders have only one slot available for digital inputs and relay outputs for either a 4 or 8 channel Alarm Relay card or an 8 or 16 channel Digital I/O card fitted in slot G, the position is identified on the rear panel. The 16 channel Digital I/O card is not available on the **eZtrend GR** recorders.

The **Multitrend GR** can have up to three Alarm Relay cards fitted in any combination of Alarm Relay card or Digital I/O cards. The first Alarm Relay card or Digital I/O card is fitted in slot G, any additional cards will locate in positions H and I.



WARNING

HAZARDOUS VOLTAGES

Digital Input/Output card channels must not be connected to any hazardous live voltages (no higher than 30V AC rms or 60V DC).

Alarm Relay Card channels

Alarm Relay Card channels can be connected to hazardous voltages up to 300V AC, at Measurement Category CAT II (Overvoltage Category II)

Failure to comply with these instructions could result in death or serious injury.

NOTICE

For 12 and 16-way connectors; torque setting 0.4 Nm/3.5lb-in. Do not over tighten. Recommended wire size for termination connector is 22-12 AWG (22-14 SWG)

4 and 8 Alarm Relay Cards

The 24-way connector for the **Alarm Relay Card**, connects to 3 A, 240 VAC SPCO relays. The pin-outs for 4 and 8 relay Alarm Relay cards are numbered from left to right and they read as follows for each channel; NC (normally closed), C (common), NO (normally open). Devices driven by the relays are connected via two 12-way screw terminal plugs.

The last two channels, 7&8, 23&24 or 39&40, can be used as digital inputs, connect across Common (C) and Normally Open (NO).

CAUTION

IMPROPER MAINS SWITCHING

For 8 channel Alarm Relay cards.
Switching mains on the normally-open contact on channels 7 and 8 is not recommended, as surges and spikes on the mains supply could cause damage to the input circuitry. The normally-closed contact is unaffected, and can be used like all the other channels.

A Form C dry contact relay is used for this type of card. The inputs are designed to accept “Dry contact, no volt inputs”. The relays should be used for non-inductive loads only where a device requires a voltage to operate it, such as a 12 Volt buzzer, connect it to the normally open (NO) contacts (unless the fail-safe setting is activated).

The maximum voltage which may be used with the alarm relays is 240V

Alarm Relay Channel Numbers

The Alarm Relay cards are either 4 or 8 channels with a full length connector taking up 8 channels even though the cards only operate on 4 channels or 8 channels. The 8 channels Alarm Relay card has 2 digital inputs available on the last 2 channels. There are no Digital Inputs available on the 4 channels Alarm Relay card.

Table 2.7 :

| Alarm Relay card 4 channel | | | Alarm Relay card 8 channel | | |
|----------------------------|----------------|----------------|----------------------------|----------------|----------------|
| Card position | Channel number | Digital Inputs | Card position | Channel number | Digital Inputs |
| Slot G | 1 to 4 | N/A | Slot G | 1 to 8 | 7 & 8 |
| Slot H | 17 to 20 | N/A | Slot H | 17 to 24 | 23 & 24 |
| Slot I | 33 to 36 | N/A | Slot I | 33 to 40 | 39 & 40 |

DR Graphic recorders alarm card slot position and channel number mapping

Table 2.8 :

| Alarm Relay card 8 | | |
|--------------------|----------------|----------------|
| Card position | Channel number | Digital Inputs |
| Slot B | 1 to 8 | 7 & 8 |

Figure 2.17 Alarm Relay Card connector details

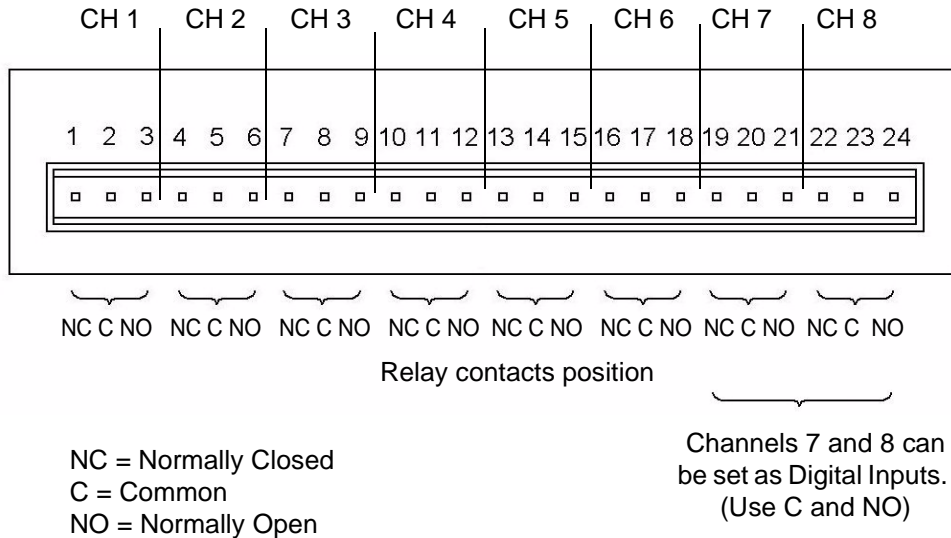

8 and 16 Digital Input/Output Card

The 16 channel Digital I/O card is not available on the **eZtrend GR** recorders.

The **Digital Input/Output Card** has 1A 24V DC rated relays that are connected via two 16-way connectors, the left connector for the first 8 channels and right connector for the second 8 channels. The pin-outs for 8 and 16 I/O cards are labelled from left to right, 1 to 16 on the left side and 17 to 32 on the right. Each channel can be set up as an input or an output. For output the relay is normally open type.

A Form A dry contacts relay is used for this type of card. The inputs are designed to accept “Dry contact, no volt inputs”.

NOTICE

For Digital Inputs, short together the 2 pins of the channels with a switch or a relay.

Pulse Inputs

The 8 and 16 Digital I/O option card has 4 channels that can be set as pulse inputs (first 4 channels). The operating frequency for pulse inputs on the Digital I/O card is 1kHz max.

Input: Low < 1V, High >4.5V to <10V DC (9V to 20V p-p AC) or Volt free input: Low = short circuit, High = open circuit.

Figure 2.18 Digital Input/Output card connector details

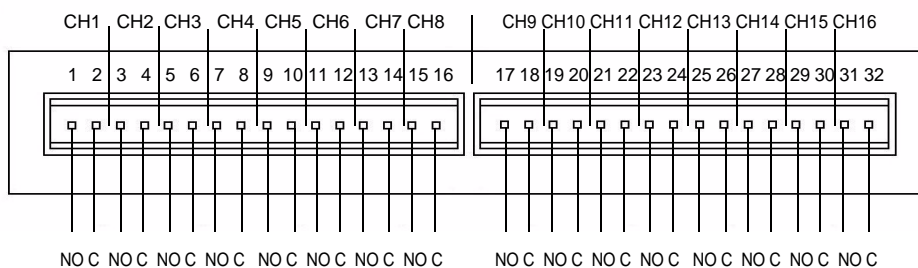

NO = Normally Open
C = Common

Digital Input Card Channel Numbers

The Digital input cards are either 8 or 16 channels with a full length connector taking up 16 channels even if only 8 channels are in operation. Both the digital input cards can be used as a relay card if required.

Table 2.9 :

| Digital Input card 8 channel | | Digital Input card 16 channel | |
|------------------------------|----------------|-------------------------------|----------------|
| Card position | Channel number | Card position | Channel number |
| Slot G | 1 to 8 | Slot G | 1 to 16 |
| Slot H | 17 to 24 | Slot H | 17 to 32 |
| Slot I | 33 to 40 | Slot I | 33 to 48 |

The 16 channel Digital I/O card is not available on the **eZtrend GR**.

DR Graphic recorders Digital I/O card slot position and channel number mapping

Table 2.10 :

| Digital Input card 8 channel | | Digital Input card 16 channel | |
|------------------------------|----------------|-------------------------------|----------------|
| Card position | Channel number | Card position | Channel number |
| Slot B | 1 to 8 | Slot B | 1 to 16 |

Communications Connections

Ethernet

The Ethernet port is fitted to all **GR Series** recorders as standard and uses a standard RJ45 Ethernet connection. After connection, select the Ethernet port from the Comms menu and select the required protocol from the Protocol menu eg. Modbus.

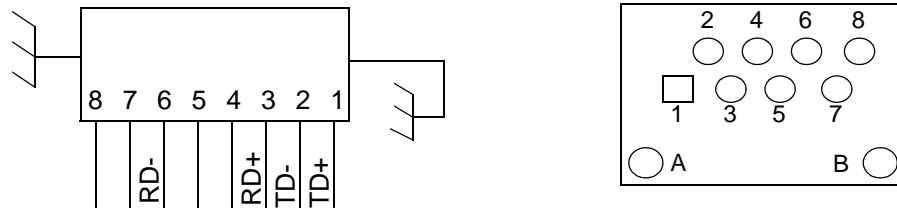

RJ45 Pin 1 is to the right from the rear of the unit

24V DC Instrument Power Input

24V DC instrument power is available on all **GR Series** recorders as an option. It is connected using 3-way connector, mating half is supplied. Diagram shows a view looking from the rear of the unit.

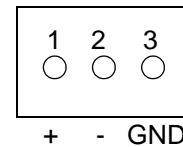

RS485 Minitrend GR, Multitrend GR and DR Graphic recorders.

The RS485 port is fitted as standard as a part of the processor card and uses a 3-way connection. After connection, select the RS485 port from the Comms menu and select the required protocol from the Protocol menu eg. Modbus. Diagram shows a view looking from the rear of the unit. See [“Comms Services Menu” on page 101](#).

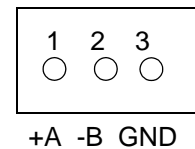

SPNC Relay Minitrend GR, Multitrend GR recorders.

(Single Pole Normally Closed). 2-way connector. This is a fail safe relay which means if the power goes off the relay closes and can be set to trigger an alarm. So should the power fail the relay is in a “fail safe” condition. Diagram shows a view looking from the rear of the unit. Either pins can be Common or Normally closed.

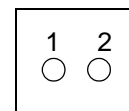

NOTE: Once the recorder is powered up, if there are no active alarms associated with the “Fixed Relay”, the contacts will open. When the alarm is on they will close.

eZtrend GR Expansion Card

This is an interface card that is required when fitting the following option cards:

- Analogue Input card in Slot B (up to 6 channels)
- Four Relay output card
- 8 Relay/2 Digital Inputs card (6 fixed Outputs/2 Configurable DI/DO)

Electrical Installation

- 8 Configurable Digital Inputs/Discrete 24V Output card

USB Devices

Print Support (USB 2.0)

Print Support is a firmware option that can be activated using the credit system, refer to the Options item in [“Credits” on page 131](#).

Not all printers will be compatible with the print support feature on the recorder. The guidelines are they must be a USB printer that shows as a standard PCL3 (Printer Command Language). The system will not support multi function devices or printers that require specific drivers. Avoid photo printers and printers that allow stand alone operation with cameras or media specific printers such as pictbridge.

There isn't a constant factor to which printers work and those that wont. We recommend that you follow the guidelines outlined here and plug it in and see.

To set up your printer configuration go to [“Printer Menu” on page 141](#).

Keyboards

All keyboards are native USB 2.0 keyboards. English and US keyboards are recognised as US layout (QWERTY) for all languages except French and German keyboard layouts. French and German keyboards are activated when the recorder is set to that language. There is no keyboard support for Asian languages (Chinese simplified, Japanese or Korean).

USB Keys (USB 2.0)

Please test your USB key before using it for recording and transferring data.

Section 3: Overview

Functions and Features

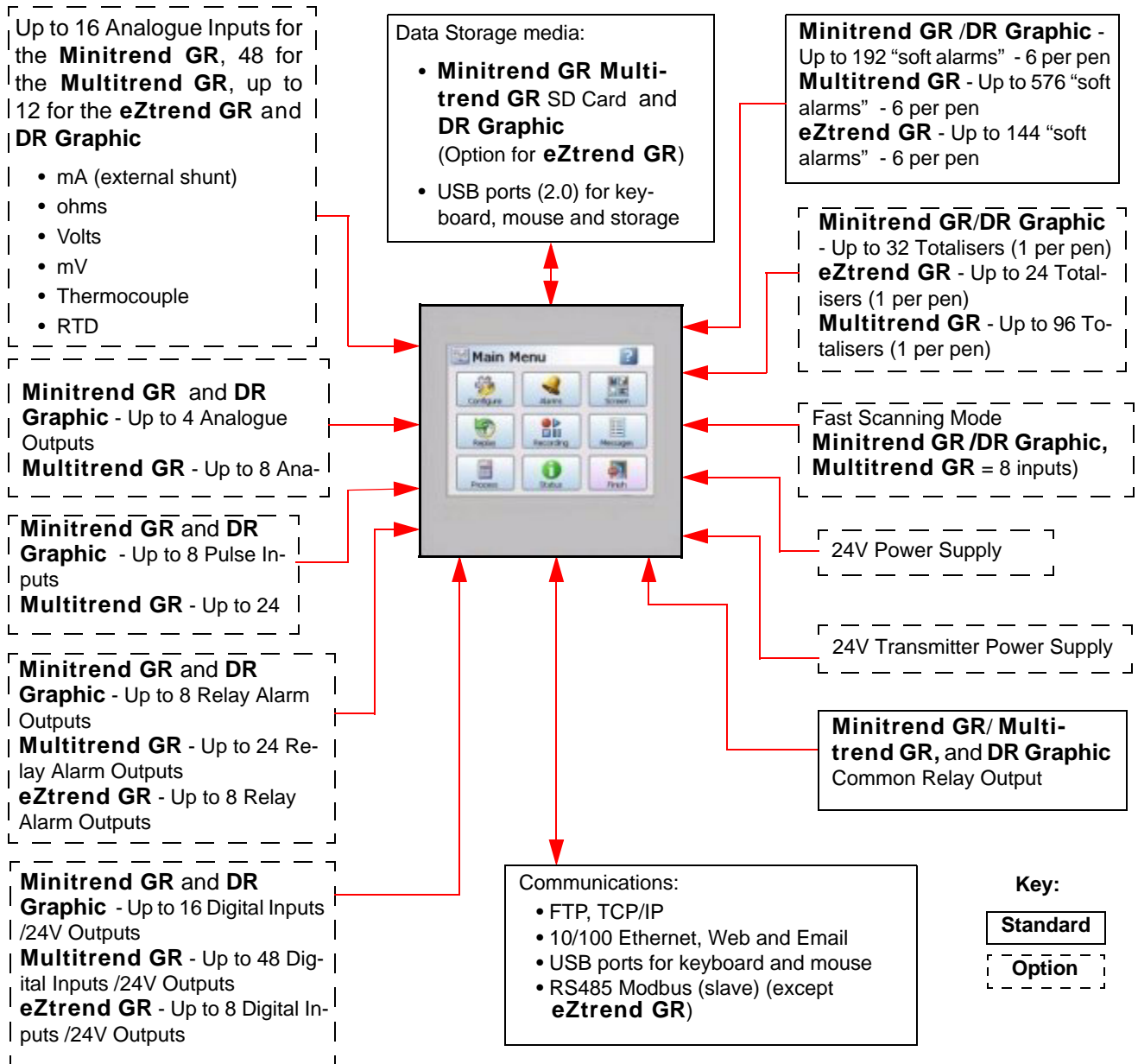

Crystal Clear Display

- **Minitrend GR** has a 5.7" Digital Colour LCD (TFT), VGA Resolution (640 x 480 pixels)
- **Multitrend GR** has a 12.1" Digital Colour LCD (TFT), VGA Resolution (1024 x 678 pixels)
- **eZtrend GR** has a 5.7" Digital Colour LCD (TFT), QVGA Resolution (320 x 240 pixels)
- **DR Graphic** has a 12.1" Digital Colour LCD (TFT), XGA Resolution (1024 x 768 pixels)

Functions and Features

- Clear and intuitive operation, Industrial rugged Touch Screen with rapid navigation
- Custom build screens in the recorder or using Screen Designer (not **eZtrend GR**)

Comprehensive Connectivity

- 10/100 Ethernet (DHCP), Web and E-mail
- FTP and TCP/IP transfer of encrypted data by using **Trend Server Pro** software.
- RS485 Modbus Protocol (not available for the **eZtrend GR**).
- USB ports for keyboard, mouse and printer.

Data Storage

- On-board non-volatile Flash memory - up to 4GB for **Minitrend GR**, **Multitrend GR** and the **DR Graphic** recorders - up to 2GB for **eZtrend GR**.
- Removable SD card and USB storage ([See "Storage Media Format" on page 184.](#)) for formatting information of SD cards and USB keys). SD card is an option for the **eZtrend GR**.
- No moving parts - all solid state flash memory

Security Stringent - Total Data integrity

- Password Protection - 21CFR Part 11
- ESS - Extended Security System
- Password Network Synchronisation
- Hardware Configuration Lock

Plus..

- Health Watch for preventative maintenance
- Remote Access - Advanced Software Data Analysis at your PC
- Independent Chart and Logging speeds
- Global Language Support
- Rapid review and replay of data at recorder
- Approvals - CE, cCSAus, UL, FM approval for the **Minitrend GR**, **Multitrend GR** .
- NEMA 4X / IP66 option.
- AMS2750 functionality (option)
- Active X control
- French and German USB keyboard compatibility
- Time Sync on Digital inputs
- Password Net Sync a group of up to 32 recorders (1+ sync 31)
- Temperature Uniformity Survey functionality option (AMS 2750) only **Multitrend GR** and the **DR Graphic** recorders
- Logging speed up to 50Hz (20 msec), 10Hz (100msec) for **eZtrend GR**.
- Up to 16 Analogue Inputs for the **Minitrend GR** and the **DR Graphic**
- Up to 48 Analogue Inputs for the **Multitrend GR**
- Up to 12 Analogue Inputs for the **eZtrend GR**

Functions and Features

- Remote Viewer via the recorder web page
- Events - set up occurrences to trigger actions
- Single and concurrent batch capability
- Print Support
- Counters
- Modbus master communications
- Alert System
- Sound system - add sound effects to identify occurrences
- Email facility - the recorder will email an event notification and include a screen shot of the occurrence as an attachment.
- Pre and Post Trigger alarm function
- CSV Export

Recorder Functionality

- **GR** recorders provide flexible electronic data acquisition and recording in a high functionality instrument. **Minitrend GR** is a DIN standard 144mm format recorder with a 5.7" VGA display and the **Multitrend GR** is a large 12.1" diagonal VGA display format recorder. The **eZtrend GR** is a DIN standard 144mm format recorder with a 5.7" QVGA display.
- The **Minitrend GR** and the **DR Graphic** recorders have up to 16 Analogue inputs, and the **Multitrend GR** has up to 48 Analogue inputs and the **eZtrend GR** has up to 12 Analogue inputs.
- **Minitrend GR, Multitrend GR** and the **DR Graphic** recorders have 1GB to 4GB of expandable non-volatile flash memory available plus additional removable storage media, the **eZtrend GR** has 1Gb to 2GB.
- All recorders use digital colour TFT LCD screens to provide easy to read displays with wide viewing angles for the best all around data viewing.
- The touch screen operator interface provides fast, easy access to the recorder menus making set up and data analysis quick and efficient. Navigation through the menus and text entry are direct and intuitive.

Functions and Features

Example of a recorder menu path from the Main Menu to change the Pen Scale configuration with clear rapid navigation

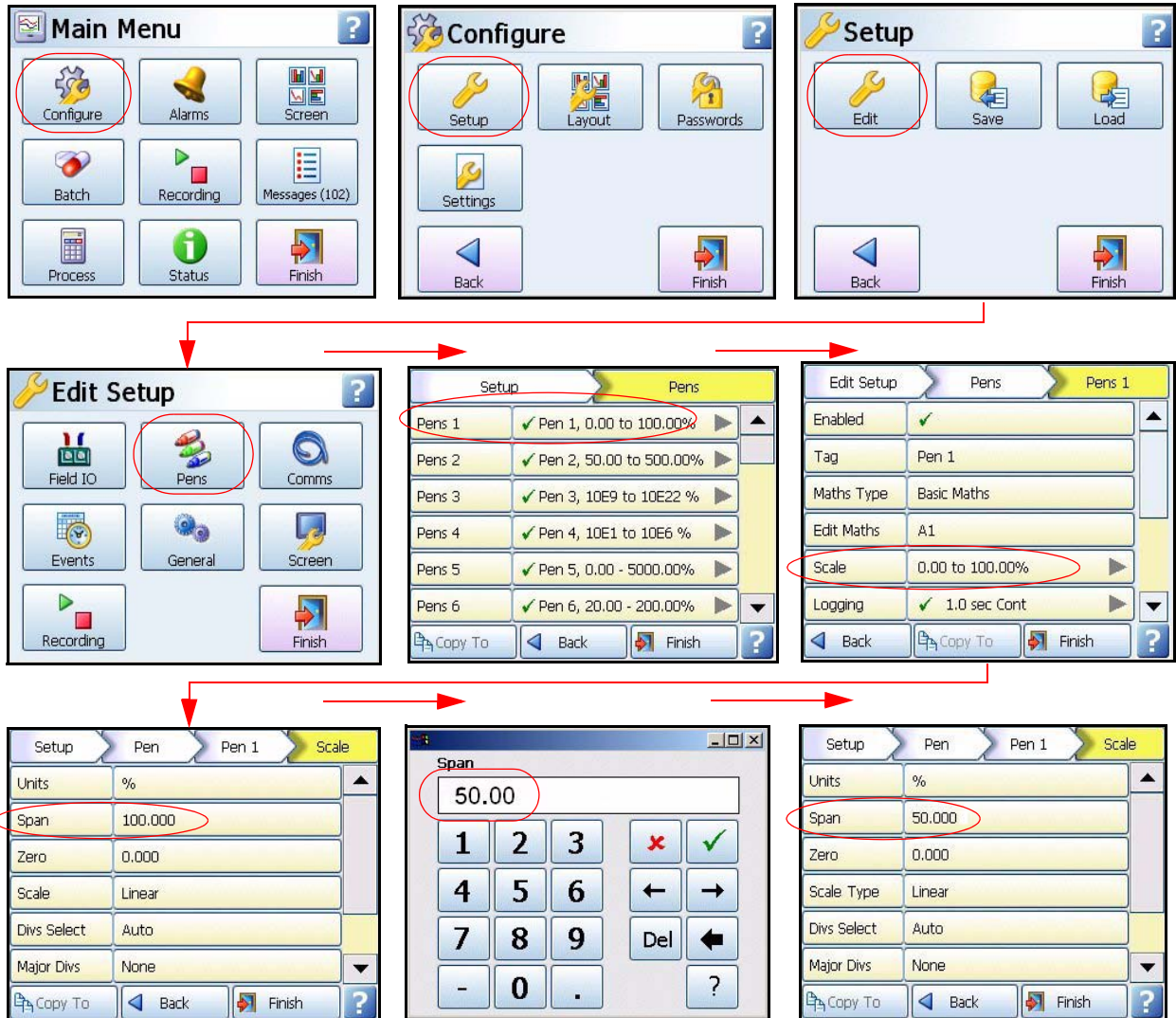

Features

Display

- **5.7" Colour Active TFT** for the **Minitrend GR** and **12.1" Colour Active TFT** for the **Multitrend GR** and the **DR Graphic** and **5.7" Colour Active TFT** for the **eZtrend GR** - with more than 256,000 colours makes it easy to interpret process data and take action with the intuitive bar charts, digital values, trends or customised displays. A screen saver function can be set from 1 to 720 minutes to extend the life of the backlight.
- **Touch Screen** - the heavy duty durable touch screen provides easy data entry and rapid navigation through the menus.
- **Help Files** - A complete contextual help system can be accessed and visualised on the screen of the recorder.

Communications

- **Ethernet Connectivity** - the Ethernet (DHCP standard) connection, with support for various protocols, provides comprehensive connectivity to local area networks (LANs). The standard Ethernet interface makes networking of the recorder to a LAN or the world wide web fast and convenient. Dynamic Host Configuration Protocol (DHCP) automatically acquires the settings (IP address) for network communications from a DHCP server. Modbus Master and Modbus Slave facility now available for all recorders.
- **RS485 Modbus** - the RS485 connection allows process data to be transferred to other devices, or to record data received in MODBUS RTU protocol (slave mode only). Modbus Master and Modbus Slave facility now available for all recorders. (RS485 not available for the **eZtrend GR** recorder).
- **Simple Network Time Protocol (SNTP)** - The recorder can be synchronised over the ethernet network via a SNTP client or synchronise other recorders via a Server.
- **Web Server** - with the recorder connected to a LAN, all process variables, alarm and messages can be viewed from an internet browser; values are automatically refreshed.

Data Storage

Internal Data Storage - 1GB to 4GB of expandible internal non-volatile flash memory is available for data storage and chart history (replay of data on the display)

| Internal memory / Logging rate = 1 sec | | | | |
|--|------|-----------|-----------|-----------|
| Type | Pens | 1GB | 2GB | 4GB |
| Minitrend GR | 4 | 1000 days | 2000 days | 4000 days |
| eZtrend GR | 4 | 1000 days | 2000 days | - |
| DR Graphic recorders | 4 | 1000 days | 2000 days | 4000 days |
| Minitrend GR | 8 | 500 days | 1000 days | 2000 days |
| eZtrend GR | 8 | 500 days | 1000 days | - |
| DR Graphic recorders | 8 | 500 days | 1000 days | 2000 days |
| Minitrend GR | 16 | 250 days | 500 days | 1000 days |
| Multitrend GR | 16 | 250 days | 500 days | 1000 days |
| DR Graphic recorders | 16 | 250 days | 500 days | 1000 days |
| Multitrend GR | 32 | 62 days | 155 days | 310 days |
| Multitrend GR | 48 | 40 days | 103 days | 206 days |
| Multitrend GR | 96 | 20 days | 51d days | 103 days |

Functions and Features

Data Export - Removable SD Card and USB flash (2.0) storage device provides multiple data storage alternatives. Data is stored in a secure binary encrypted format, with the recorder's configurations, providing added security of the data files. SD Card is available for the **eZtrend GR** recorder as an option. Optional CSV export capability

Removable SD Card and USB flash storage devices. (SD card option for **eZtrend GR**)



External USB (2.0) Devices

- The **Minitrend GR** and the **Multitrend GR** recorders have two USB host ports, one front and one at the rear.
- 2 USB ports for **DR Graphic** are extended inside the case to a dual panel mount receptor above the power supply. USB peripherals/wires can be connected on the panel mount connector for inside the case.
- The **eZtrend GR** recorder has one front USB Host. The USB ports can be used for attaching external USB devices such as a keyboard, mouse or a USB data storage key. The keyboard and mouse can be used to navigate the recorder's screen along with text entry.

SD CARD

Default 1GB SD Card for internal SD card.

CAUTION

SD CARD Handling precautions

- Do not store or use the SD memory card in places with static electricity, near electrically charged objects, or
- where electrical noise is present. Doing so can result in shock or damage.
- Do not disassemble or modify the SD memory card. Doing so can result in damage.
- Do not physically shock, bend, or pinch the SD memory card. Doing so can lead to malfunction.
- During reading/writing of data, do not turn OFF the power, apply vibration or shock, or pull out the card. Data can become corrupt or permanently lost.
- Only use Honeywell SD memory cards. Operation cannot be guaranteed with other brands of card.
- When inserting the SD memory card into the instrument, make sure you orient the card correctly (face up or down) and that you insert it securely. If not inserted correctly, the card will not be recognized by the instrument.
- Never touch the SD memory card with wet hands. Doing so can lead to shock or malfunction.
- Never use the SD memory card if it is dusty or dirty. Doing so can lead to shock or malfunction.
- You can use SD/SDHC cards (1GB to 32 GB)

Remote Viewer

- This is a firmware option that extends the user interface of the recorder onto the desktop PC. Providing remote viewing of the unit launched from a web browser. Full remote control is available as an option which is password protected to prevent unauthorized access. Compatible with Microsoft™ Internet explorer 6 to IE10. Separate Remote View application available for viewing the recorder screen remotely over the Ethernet link.

Security

- **Total Data Integrity** - data is stored in secure encrypted files making it easy to retrieve the data dependent on process information. Data is automatically recognised without having to remember file names.
- **Password Protection** - Up to 4 levels of password protection with up to 50 different users are available. Multiple levels of password protection and an audit trail of actions enhance the security of the data.
- **Password Network Synchronisation** is a credit function in the recorders that provides a means of keeping the passwords of users in sync for network connected recorders. It uses a Password Master/Slave setup to update password changes.
- **Extended Security System (option)** - ESS provides features including entry of unique User ID's and associated passwords, time-out of password entry, password expiration, and traceability of user actions. ESS is compatible with the requirements of 21CFR part 11.
- **Hardware Configuration Lock** - The Hardware Configuration Lock feature located on the processor card and works in conjunction with the Credit function to prevent any configuration changes once the configuration switch has been set to the "locked" position. See ["Options" on page 196](#). The switch must be reset to the "unlock" position to make configuration changes. See ["Hardware Configuration Lock" on page 224](#).

Events

Events is a firmware option that can be activated using the credit system. Events are certain conditions or operations which can be set up and logged according to the time and date of the occurrence. Subsequently events can be reviewed in a list or represented on a graph. An Event is made up from a Cause and an Effect. For example, set up a cause such as Pen 1 going into an alarm state and the effect of this could be to start a totaliser or acknowledge the alarm.

Batch

The Batch function allows the user to segment portions of data for further analysis. Batch enhances the management of data collected in a non-continuous process, known as batch processing, used in thermal treatment, sterilisation, food processing and chemical reactions. Concurrent batch mode is now available where each batch is associated to a group of pens. Other features include Batch logging control, Automated batch counters and Event driven batch control.

Batch feature for the **GR Series** has been enhanced to have all the data entry on a single screen. Batch Wizard is still available.

The Single Screen Batch allows you to view and enter all the batch details on a single screen. The batch fields viz. Batch Name, User Id, Lot Number, Description and Comment are available for viewing and entering details on a single page which is unlike the batch wizard where you navigate each page to enter details of subsequent fields. The Lot number is unique for each batch on a recorder and user can enter the Lot number from the recorder. This is irrespective of whether you are using Batch Wizard or Single Screen Batch to enter the batch details. You can also set the above fields except Lot Number from a set of predefined list.

Batches are controlled with command lines entered into the recorder, these include Start, Stop, Pause, Resume and Abort batch. Batch Markers are placed on to the recorder's chart and entered into the messages system for every batch command applied.

Counters

Up to 16 User Counters are available and can be used as a part of the Events system. User Counters can be set up as a Cause or an Effect of an Event. A Counter Effect can be used to count an occurrence or to reset different types of counters depending on hardware availability. Other counters available are Alarm, Event, Digital Input, Relay Output and Pulse counters.

Other Standard features ..

- **CE Mark** - Conformity with 2006/95/EC, Low Voltage and 2004/108/EC EMC Directive.
- **Soft Alarms** - 6 "software" alarms per pen are easily set up to display and record selected out-of-limit conditions. These can be tied to the relay or digital outputs to activate the user's external equipment.
- **Common Relay Output** - A separate relay output at the rear of the unit can be set up as an alarm output.
- **Communications** - the recorder supports FTP, Modbus TCP/IP (master and slave mode), Web and E-mail over Ethernet (DHCP standard) communications port and Modbus RTU (master and slave mode) via an RS485 port (**Minitrend GR, Multitrend GR and DR Graphic** only). USB ports allow the use of an ASCII barcode reader. Email sent to your network connected PC triggered by an Alarm or an Event.
- **Independent Display Chart Speeds and Logging rates** - logging rates can be programmed completely separate from the chart display speed, allowing the data to be displayed and stored at the rates that best suit the application.
- **Language Support** - standard language prompts for English UK & US, French, German, Italian, Spanish, Brazilian, Polish, Hungarian, Slovak, Czech, Turkish, Romanian, Russian, Greek, Portuguese, Chinese, Japanese, Korean and Bulgarian. Also Asian languages including Chinese (simplified), Japanese and Korean (options).
- **Logarithmic Scales** - all displayed scales can be set as linear or logarithmic. max 99 decades
- **Enclosure rating** - Standard NEMA 3R/IP55 for **Multitrend GR** recorder, NEMA3/IP55 for **Minitrend GR, DR Graphic** recorders and **eZtrend GR** recorders. NEMA 4X / IP66 available as an option.
- **Fuzzy Logging** - this standard feature provides a unique method to increase the storage capacity of the recorder. The data is monitored to determine changes in process data; if no changes are observed data is logged periodically. If data is changing rapidly, it is recorded normally at the programmed rate. By not logging data that is static, data compression of up to 100:1 or more can be achieved saving valuable memory.
- **Security tag** - "wire seal provision" provides added security to seal the front door and rear when using optional rear cover to prevent undetected entry to these areas of the recorder.
- **USB Ports** - (USB 2.0) Front and rear USB host ports for data and setup transfers or remote screen through these ports. Attach external devices (keyboard or mouse).
- **Replay with Zoom** - Select replay mode and zoom-in on a specific area on the screen. The data can easily be replayed at the recorder with the ability to "zoom". The touch screen makes it fast to review and analyse historical data. A "Jump" function allows you to go from the alarm list directly to the trend showing the occurrence of the alarm. Hide pens function allows you to display only the pens required for analysis.
- **Print Support** - Network printing from status, message and replay screens. Plus screen capture facility of process screens instantly using a basic USB standard PCL3 (Printer Command Language) printer.

Options - Hardware

- **Alarm & Digital IO Cards** - 4 or 8 outputs relay contacts SPCO 240V, 8 Digital I/O or 16 Digital I/O - SPNO 24VDC. (16 Digital I/O not available for the **eZtrend GR** recorder). Programmable alarm set points can be configured to activate up to 16 outputs for the **Minitrend GR**, 8 outputs for the **eZtrend GR** and **DR Graphic** recorders and 48 outputs for the **Multitrend GR**.
- **Analogue Output** - 2 or 4 outputs available per card for the **Minitrend** and **DR Graphic** with 2, 4, 6 or 8 outputs available for the **Multitrend** recorder. Output type: 0-20mA or 4-20mA. (Not available for the **eZtrend** recorder).
- **Nema 4X / IP66** - Nema 4X / IP66 protection available as an option.
- **Portable Recorders** - Portable cases available as an accessory item.
- **Digital Input** - 2 inputs on 8 channel Alarm card, 8 inputs on 8 Digital I/O card and 16 inputs on a 16 Digital I/O card. The digital inputs allow users to initiate, from a remote location through a dry contact closure, selected recorder functions. (only 8 Digital I/O available for the **eZtrend GR** recorder).
- **Pulse Frequency** - four frequency inputs per board, are available to measure pulse signals up to 25 kHz (max. 2 cards). (Not available for the **eZtrend GR** recorder, but 4 pulse inputs can be used on the Digital I/O option card to 1kHz max.).
- **Pulse Inputs** - The 8 Digital I/O option card has 4 channels that can be set as pulse inputs (first 4 channels). The operating frequency for pulse inputs on the Digital I/O card is 1kHz max.
- **Approvals** - CE, cCSAus, cULus approvals for **Minitrend GR**, **Multitrend GR** and **DR Graphic** Recorder. CE, cCSAus Approval for **eZtrend GR** Recorder. **Minitrend GR**, **Multitrend GR** also have FM class 1 Div 2 approval.
- **24VAC/DC or 48VDC Power Supply** - 20 to 55VDC / 20 to 30VAC for the **Multitrend GR** and **DR Graphic**. 12-30 VDC/12-20 VAC for **Minitrend GR**, and **eZtrend GR**
- **24VDC Transmitter Power Supply** - **Minitrend GR**, **eZtrend GR** and **DR Graphic** can supply up to 200mA to external transmitters, **Multitrend GR** up to 1A.

Functions and Features

Multitrend GR and DR Graphic Standard Screens

The **Multitrend GR** recorder has up to 32 screens available for displaying combinations of charts, bars and DPMs can be configured, 4 examples below.

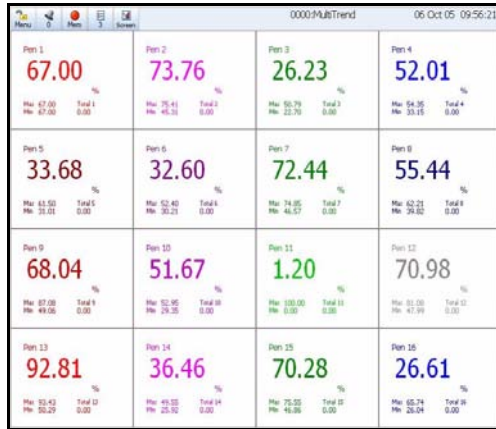

16 Digital Panel Meters showing Max/Min values and Totals for each pen

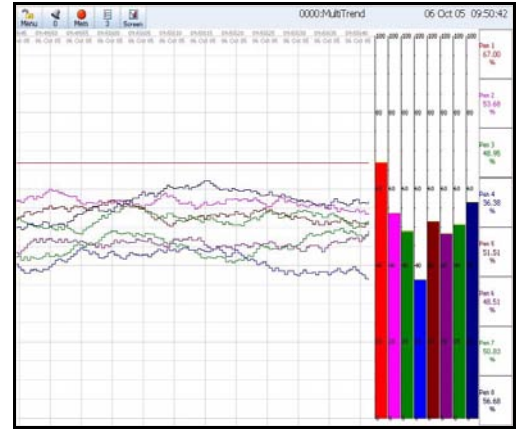

Horizontal Chart, 8 Vertical Bars & 8 DPMS

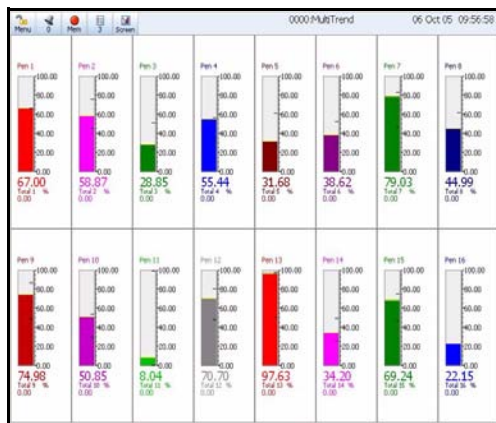

DPM and Scales



16 Horizontal Bars showing Max/Min values and Totals for each pen



Charts Menu

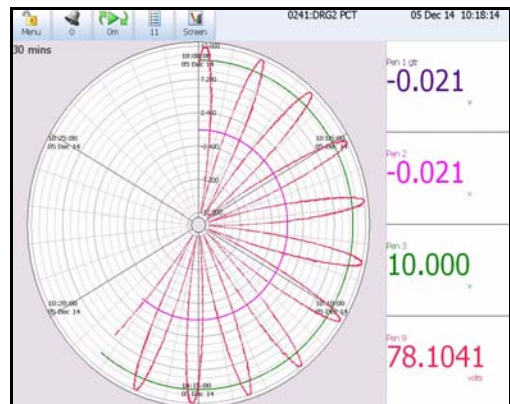

Circular Chart and DPMs

Functions and Features

Minitrend GR Standard Screens

The **Minitrend GR** recorder has up to 20 screens available for displaying combinations of charts, bars and DPMs can be configured, 6 examples below.

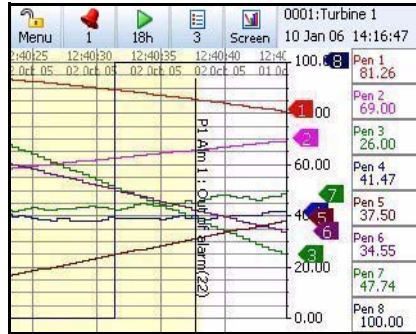

Horizontal Chart and DPMs



Horizontal Chart, 4 Vertical Bars and 4 DPMs

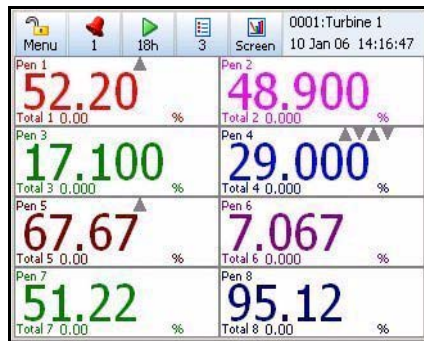

8 Digital Panel Meters

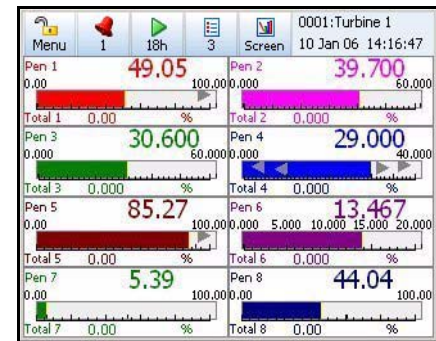

8 Horizontal Bars

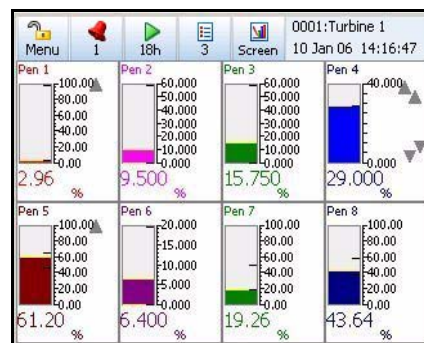

DPMs and Scales

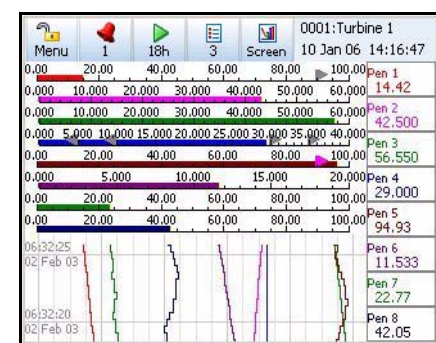

Vertical Chart, 8 Horizontal Bars and 8 DPMs

Functions and Features

eZtrend GR Standard Screens

The eZtrend GR recorder has up to 12 screens available for displaying combinations of charts, scales and DPMS can be configured, 6 examples below.

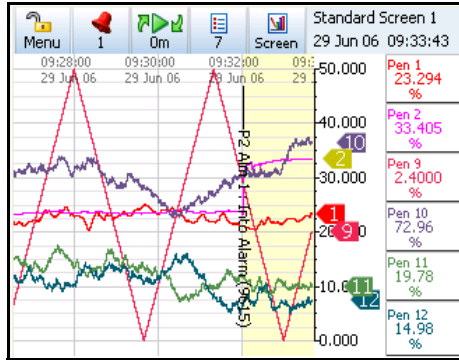

Horizontal Chart and 6 DPMS

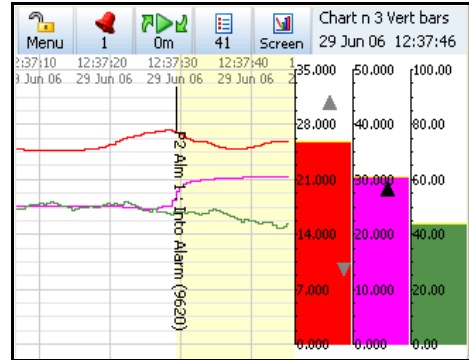

Horizontal Chart, 3 Vertical Bars

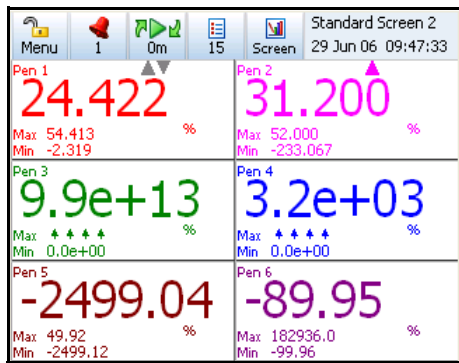

6 Digital Panel Meters

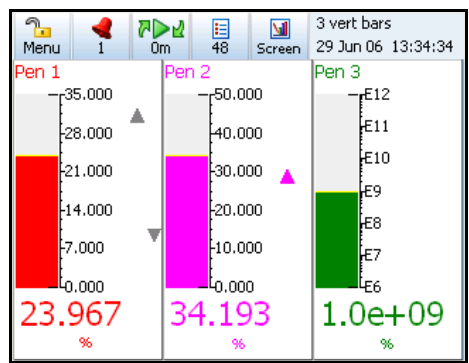

3 Horizontal Bars

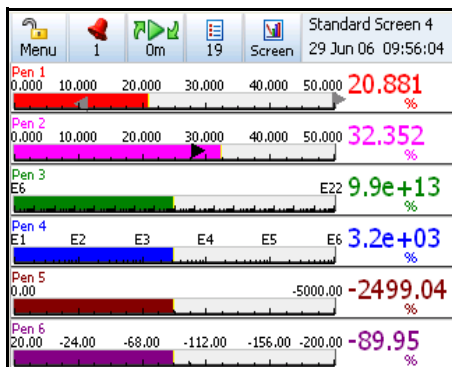

Horizontal Bars and DPMS

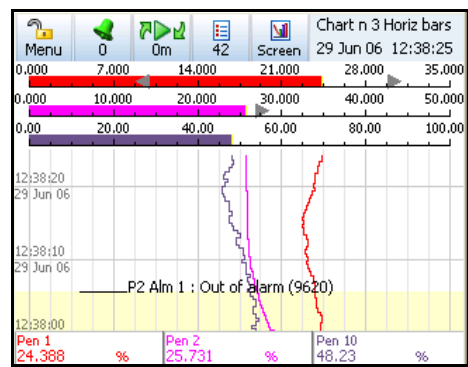

Vertical Chart, 3 Horizontal Bars and 3 DPMS

Minitrend GR Rear Connections

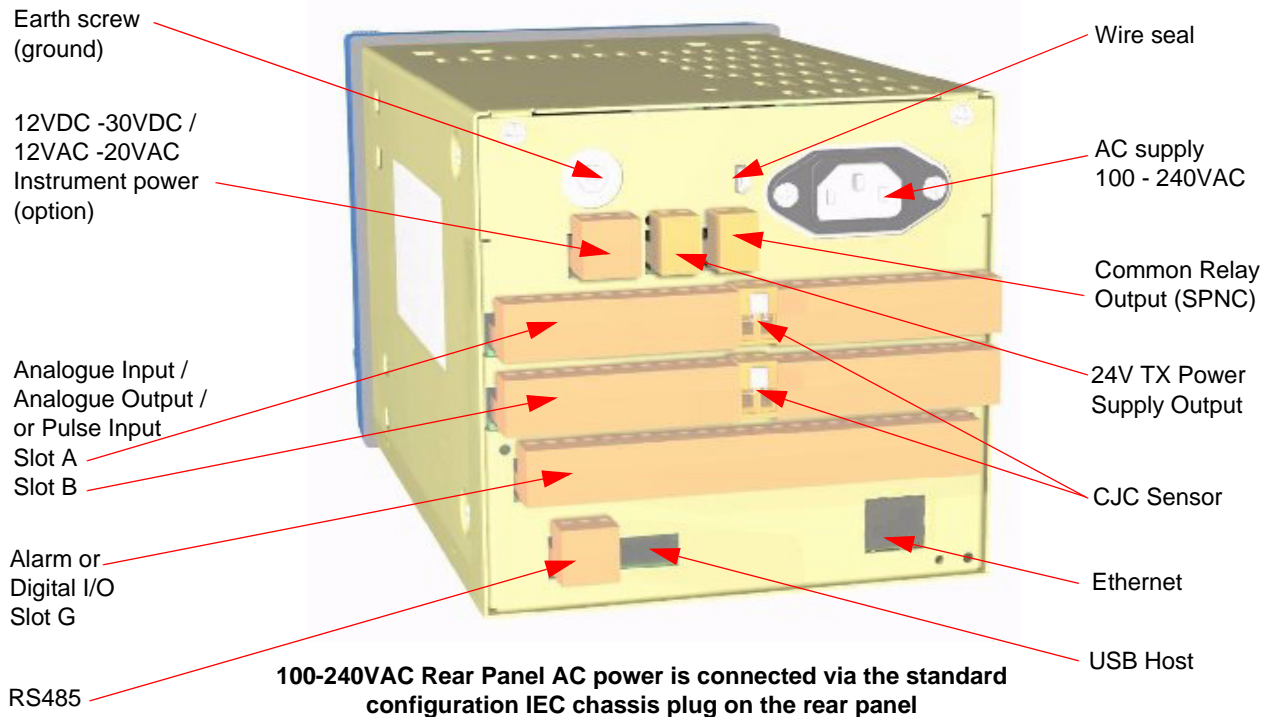

An optional rear cover is available for this recorder, it is recommended when using Thermocouples as the measurement device and to protect the wiring and terminals
 For the rear cover part number, see [“Section 10: Spares List” on page 281](#).

Functions and Features

eZtrend GR Rear Connections

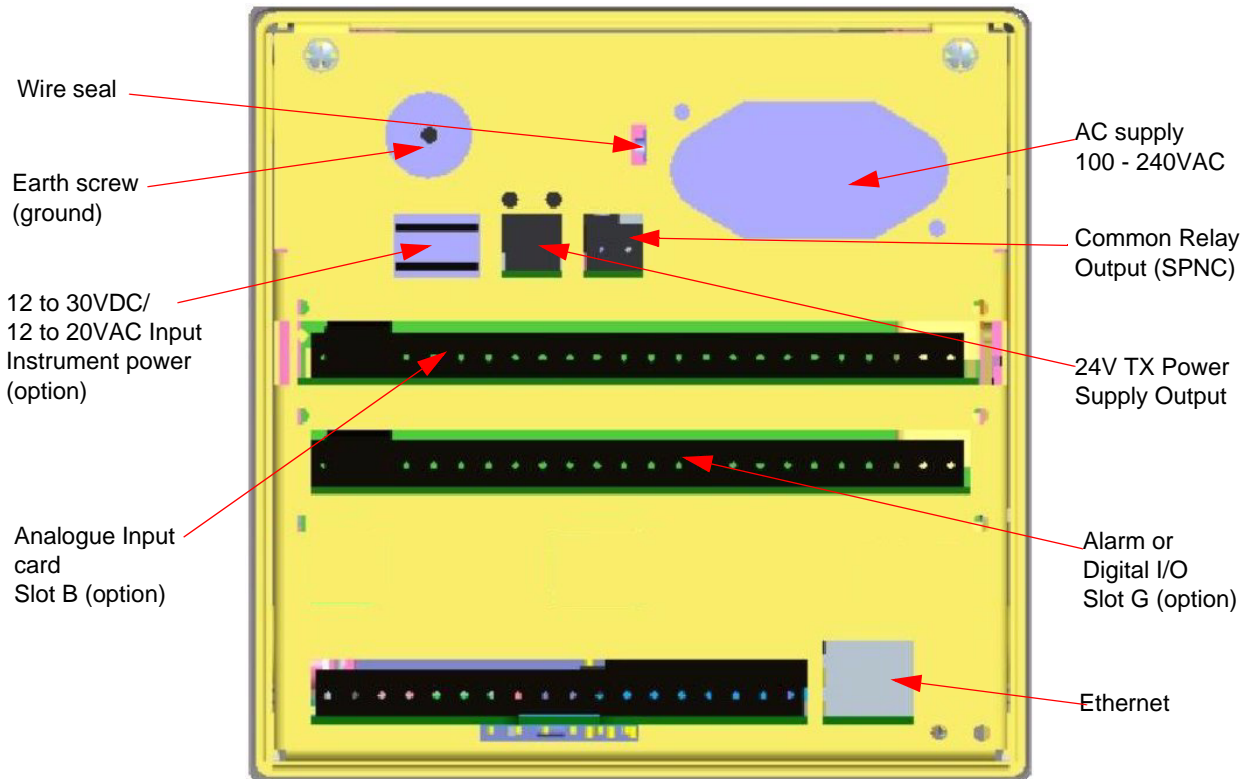

100 - 240VAC Rear Panel AC power is connected via the standard configuration IEC chassis plug on the rear panel

An optional rear cover is available for this recorder, it is recommended when using Thermocouples as the measurement device and to protect the wiring and terminals
For the rear cover part number, see ["Section 10: Spares List" on page 281](#).

Multitrend GR Rear Connections

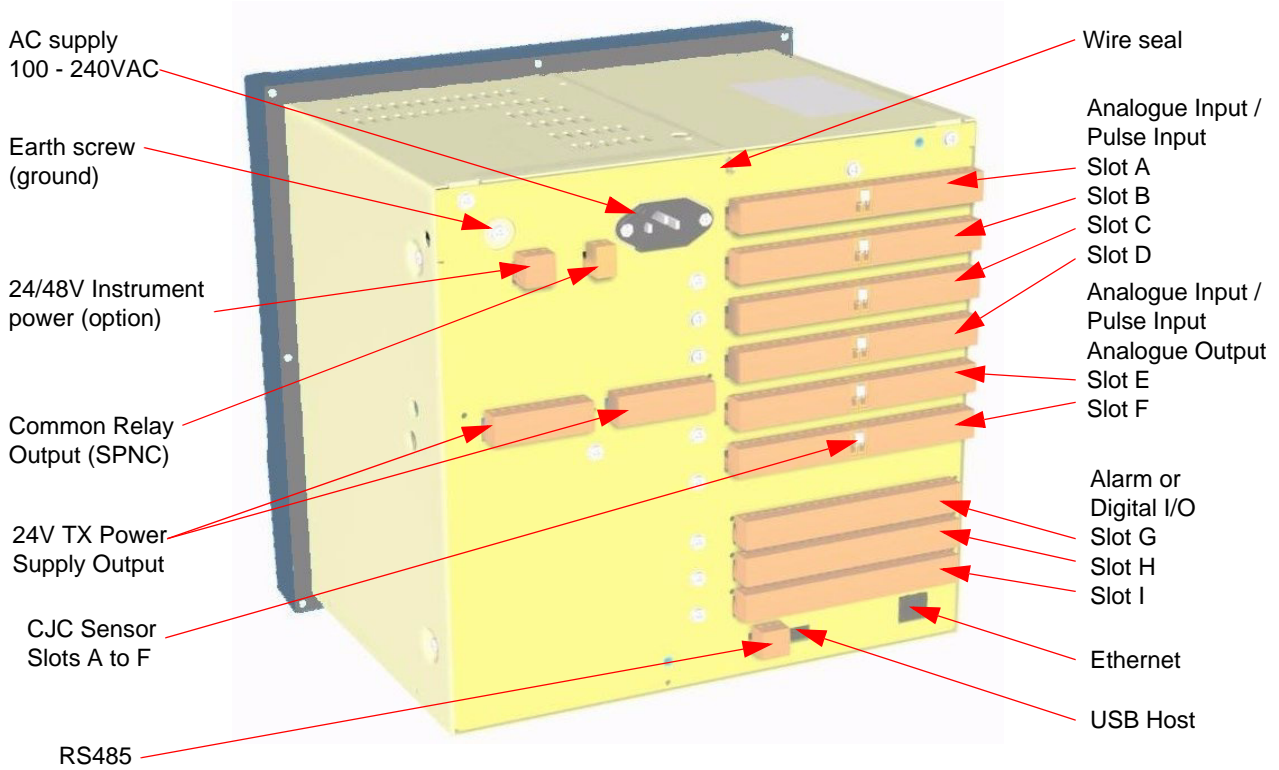

100-240VAC Rear Panel AC power is connected via the standard configuration IEC chassis plug on the rear panel

An optional rear cover is available for this recorder, it is recommended when using Thermocouples as the measurement device and to protect the wiring and terminals
For the rear cover part number, see ["Section 10: Spares List" on page 281](#).

Functions and Features

Section 4: Recorder Setup

Configuration of the recorder is performed in the Menu screens and the data is displayed in the Process screens. This section takes you through the Menu system and how to set up your recorder. See [“Section 6: Screen Configuration” on page 225](#) for information on setting up screens to display the data.

User Interface Control

All user actions can be performed via the touch screen using the stylus. All on-screen selection and navigation areas are large enough so the unit can be operated without falsely selecting an adjacent option using the stylus provided.

The stylus is to be used to operate the touch screen. It has a rounded end to avoid damage to the screen. Only a light touch is required to activate the screen. Two styluses are provided and there is a special slot at the top of the recorder to slide the stylus in from the right. If the touch screen does not match correctly to where you are touching it with the stylus the screen may need calibrating. See [“Calibrate” on page 179](#).

Other User Interface Control

All user actions can be performed using a mouse or keyboard attached to a USB host port.

Power up

1. Menu Access

When the recorder is powered up the display will show a splash screen followed by an initialisation screen displaying the default language flag.

The first screen to appear on the recorder is a default process screen with the menu bar at the top. Select the Menu button to access the menu system to configure the recorder. The Menu button takes you to the Main Menu.

From the Main Menu you may be required to Log In, if the Password function is active, see [“2. Log On/Off” on page 64](#). If not, the next configuration required is to set the recorder to the correct local settings, see [“3. Local Settings” on page 65](#).

Figure 4.1 Default process screen

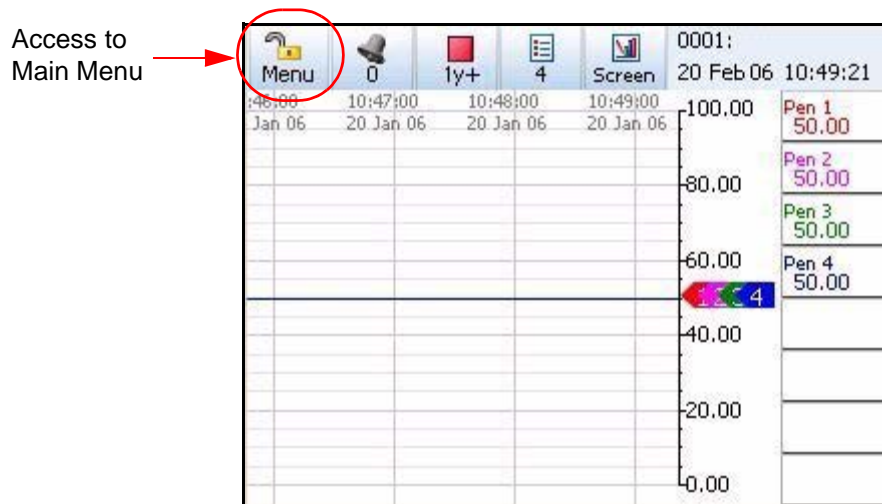

2. Log On/Off

If Password (ESS - Extended Security System, 21CFR) security is active on your recorder a password is required to enter the menu system and process screens. Limited access is available without logging on.

For ESS recorders only, locate the First Time Password System Setup sheet included in with your recorder or see [“First Time’ Password System Setup” on page 208.](#)

All Users

When Log On is required the Log On button will appear in the top right of the Main Menu screen. The Log On button can be set to switch to auto Log Off at a specified period of time. To Log On select the Log On button at the top right of the Main Menu screen.

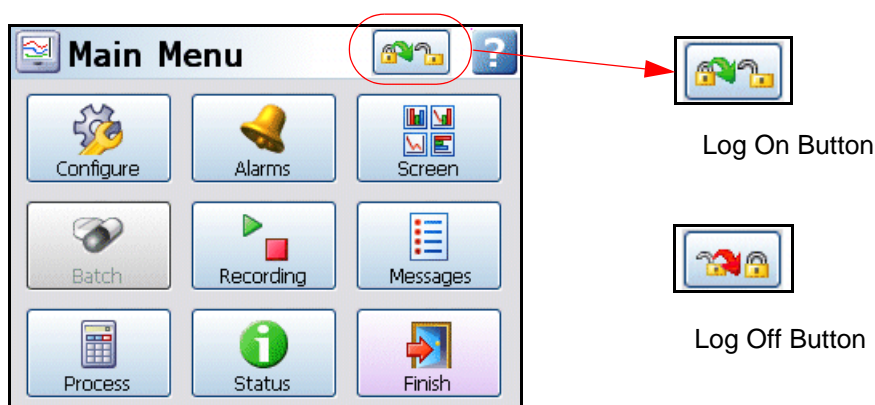

- **Log On** - User is presented with a user name and password entry box. First time user login is “Admin”. No password is required. Access for the first time user is removed once the password system has been configured.
- **Log Off** - Once the user has logged on, the option in the Main Menu will turn to Log Off, once selected the user is logged off and returned to the current process screen.

First Time Log On

The first time the system is used with ESS, a default user name and password is available, the user name is “Admin” and will have no password, this is known as the “first time” user. Access to the first time user is removed once the password system has been configured. The first time user is reinstated if the password system is reset.

For more detailed information see [“Section 5:Security” on page 207.](#)

Re-Start Recorder

NOTICE

After re-start, if the recorder asks for “Scan and Fix” or “Continue”, always select “Scan and Fix”. If you chose “Continue” you may lose the data. In case of “Scan & Fix” the recorder may take couple of more minutes more than normal to re-start, up to 2-3 minutes.

3. Local Settings

Go from the Main Menu to Configure > Setup > Edit > General > Localisation

All text is displayed in the currently selected language. Help system language can be selected independently, currently English only available. To configure local settings, languages, time zones, daylight saving, temperature units and mains frequency for input filtering, see “[Localisation](#)” on page 136 section.

Default Time Zone

Go from the Main Menu to Configure > Setup > Edit > General > Localisation > Time Zone

The recorder is set to the default Time Zone for Eastern Time (US, Canada), (GMT -5.00). When the configuration is complete select the Finish button to Commit.

4. Time and Date Settings

Go from the Main Menu to Configure > Settings > Set Time

Set the Recorder Time and Date settings, see “[Set Time](#)” on page 173.

When the configuration is complete select the Finish button to Commit.

5. Firmware Options

Go from the Main Menu to Configure > Setup > Edit > General > Factory > Credits

Check your recorder has been set up with the correct amount of credits, displayed as a number against the Credits item in the menu. Then select the Options item in the Credits menu and enable the firmware options you require by changing the cross to a tick/check symbol.

When the configuration is complete select the Finish button to Commit, Discard or Commit Later. Select the Back button to return to the previous menu.

Menu Path

As each button is selected in the menu system a menu path will appear at the top of the screen to enable the user to know where they are in the system. The user can select these buttons to return to previous menus and enables the user to jump back more than one menu at a time.





Help

Help is available on all menu screens and is context sensitive from each screen. The Help icon will reside either in the top right or bottom right on all menu screens. All the Help files have a **Home** button that will take you to the Help System main index. Navigating in the help does not stop the logging.

Main Menu

Select a button to take you to the next menu



- **Configure** - Configure the recorder through the Setup, Layout, Passwords and Settings menus. [See "Configure Menu" on page 67.](#)
- **Alarms** - Acknowledge Alarms, Alarm configuration and their associated condition and View the current alarm status. [See "Alarms Menu" on page 175.](#)
- **Screen** - The Screen Menu includes an Edit button to configure Pen/Channel mapping, Replay previous data, Screen List to change the screen currently being displayed and Clean Screen facility. There are Calibrate and Touch Test features to re-calibrate the screen. [See "Screen Menu" on page 176.](#)
- **Batch** - The Batch function manages sections of data. Batch markers are configured by the user and are used to identify and analyse batches of data. [See "Batch Setup/Batch Groups" on page 180.](#)
- **Recording** - Start or Stop recording. Export Now will transfer data to external media such as SD card, USB key or Network Share folder (NAS). [See "Recording Menu" on page 184.](#)
- **Messages** - The messages screen will display certain message areas. Specific types of messages have been put into categories or all messages can be viewed. [See "Messages Menu" on page 187.](#)
- **Process** - Controls for any process in use eg. Max/Mins, Totals, Counters, User Variables, Script Timers and Reports can be controlled from this screen [See "Process Menu" on page 190.](#)

- **Status** - Displays status information screens that are available to the user, these will provide information for reporting and diagnostic purposes. [See “Status Menu” on page 194.](#)
- **Finish** - When an operation is complete use the Finish button to Commit, Discard or Commit Later. [See “Finish” on page 206.](#)
- **Help** - The Help icon appears as a question mark on all menu screens. The Help files are context sensitive and will supply information for each menu screen where the icon appears. [See “Help” on page 66.](#)

Configure Menu

(Main Menu > Configure >)

The Configure screen gives access to the Setup, Layout, Password menus and Settings (Time and Date). The majority of the recorder configuration is done in the Setup menus.

- **Setup** - In the Setup menu the user can configure how the recorder acquires, stores and actions data. The Edit Setup gives access to sub-menus for Field IO, Pens, Comms, Events/Counters, General, Screen and Recording set up. [See “Edit Setup” on page 69.](#)
- **Layout** - The user can configure how the data is presented on the screen. From the Layouts screen choose to Edit, Saved or Load layouts in the recorder. [See “Layout” on page 157.](#)
- **Passwords** - Manages the security and access to full password configuration that allows restricted access within the recorder, providing password protection at different levels. Administrate, Load and Save passwords from this menu. [See “Passwords” on page 164.](#)
- **Settings** - Recorder settings such as Set Time to configure the recorder's time and date. [See “Settings” on page 173.](#)

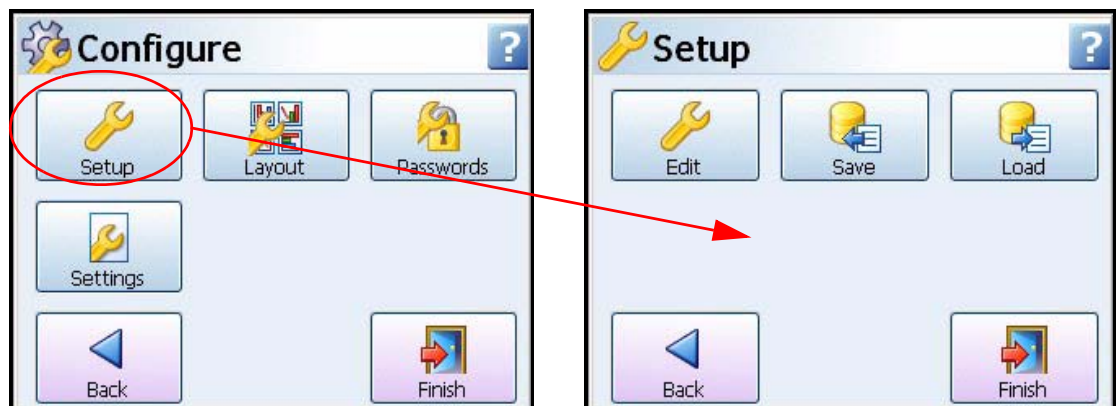

Select a button to take you to the next menu

Setup Menu

(Main Menu > Configure > Setup)

In the Setup menu the user can configure how the recorder acquires, stores and actions data. The Setup screen gives access to the Edit menu where the majority of the recorder configuration is done, also Save and Load setups from this screen.

Edit Setup

(Main Menu > Configure > Setup > Edit Setup)

The Edit Setup gives access to sub-menus for Field IO, Pens, Comms, Events/Counters, General, Screen and Recording set up. [See "Edit Setup" on page 69.](#)

Save Setup

(Main Menu > Configure > Setup > Save)

The Save button will produce a list of destinations to save the set up to and allow for naming the setup file. Maximum of 50 characters. File format is .set

The SD card and the front USB device port are found under the front flap on the recorder. There is another USB port at the rear of the recorder. The first USB device fitted will be USB1, therefore the second USB device fitted is USB2.

SD card is available as a credit option for the **eZtrend GR**.

Load Setup

(Main Menu > Configure > Setup > Layout)

Setups can be loaded from SD card, USB key or Network Share folder (NAS). The Load button will produce a list of source files to load setups from.

The SD card and the front USB device port are found under the front flap on the recorder. There is another USB port at the rear of the recorder. The first USB device fitted will be USB1, therefore the second USB device fitted is USB2.

SD card is available as a credit option for the **eZtrend GR**.

Back Button

Takes you back to the previous menu

Edit Setup

(Main Menu > Configure > Setup > Edit Setup)

Edit Setup will access the main configuration of the recorder through further sub-menus for: Field IO, Pens, Comms, Events/Counters, General, Screen and Recording set up.

The Edit button may display a warning message if the Commit Later option has been selected. This means changes to the configuration have been made but the changes have not been committed to the recorder. See [“Commit Later” on page 206](#).



Select a button to take you to the next menu

- **Field IO** - This button displays a sub menu containing Analogue In, Analogue Out, Alarm/Digital IO and Pulse Inputs card menus. See [“Field IO Menu” on page 70](#). (If AMS2750 mode is selected in the credits, this button will show IO+AMS2750, refer to [“Appendix L: GR Series AMS2750 capabilities” on page 377](#))
- **Pens** - This button displays all the configuration areas for setting up Pens including Scales, Maths, Alarms, Logging and Totalisers. See [“Pens Menu” on page 84](#).
- **Comms** - This button displays Services, TCP/IP and Network Admin. Services takes you to a sub menu containing Modbus, Web, Email, SNMP, FTP and Peers menus. See [“Comms Services Menu” on page 101](#).
- **Events/Counters** - Events and counters are firmware options that can be activated using the credit system. Events are certain conditions or operations which can be set up and logged according to the time and date of the occurrence. See [“Events Menu” on page 111](#). User Counters can be set up and used as a Cause or Effect in the Events system to count an occurrence. See [“Counters Menu” on page 126](#). Preset Markers are also available to be configured for use in the event system and as a mark on chart and Time Synchronisation on recorders on a Digital Input.
- **General** - This button displays a sub menu containing general recorder information including recorder Ident, Error Alert, Factory, Batch, Printer set up and Groups (Pens) menus. See [“General Menu” on page 128](#).
- **Screen** - This button displays a sub menu containing Screen Saver, Chart speed and screen Brightness set up. See [“Screen Saver” on page 143](#).

- **Recording** - Set up Scheduled export to media and specify the Storage Bias for recording logged and chart data. [“Edit Recording” on page 148.](#)
- **Reports** - Reports can be generated manually or on a periodical basis using event system to show daily/weekly/monthly totals, max mins, averages etc., the reports can be printed, e-mailed as attachments or exported to external media. The report details must be set up first before a report can be run, see [“Reports Menu” on page 153.](#) To run a report see [“Reports \(Process\)” on page 192.](#)

Field IO Menu

(Main Menu > Configure > Setup > Edit Setup > Field IO)

Select which type of Field Inputs/Outputs are required for configuration depending on what type of cards are fitted in the recorder.

For AMS2750 mode the Field IO button will change to IO+AMS2750. Please refer to [“Appendix L: GR Series AMS2750 capabilities” on page 377.](#)

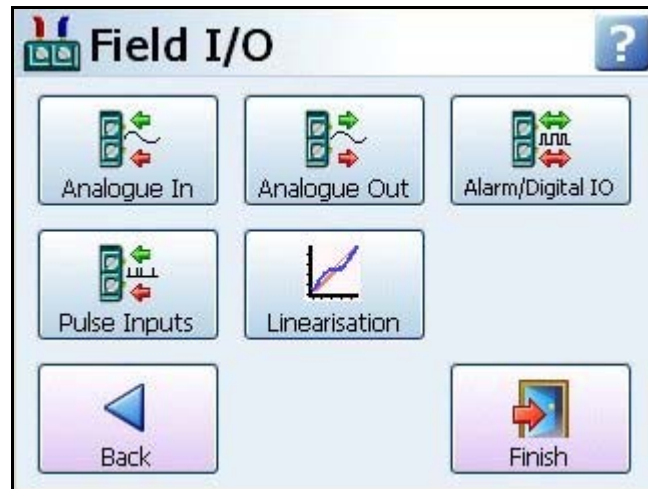

- **Analogue In** - Select this to configure each Analogue Input channel. [See “Analogue In Menu” on page 73.](#) (If AMS2750 mode is selected in the credits, this button will show Sensors, refer to [“Appendix L: GR Series AMS2750 capabilities” on page 377](#))
- **Analogue Out** - Select this to configure each Analogue Output channel. [See “Analogue Out Menu” on page 76.](#) (Not available for the **eZtrend GR** recorder).
- **Alarm/Digital IO** - Select this to configure Relay Alarm Output card or Digital Input/Output card. [See “Alarm / Digital IO” on page 77.](#)
- **Pulse Inputs** - Select this to configure each Pulse Input channel. [See “Pulse Input” on page 80.](#) (Not available for the **eZtrend GR** recorder).
- **Linearisation Tables** - To be used with Analogue Input type Volts, Amps or Ohms. These are user defined tables that can be set up to allow a non-linear input signal to be used. [See “Linearisation Tables” on page 81.](#)

Table 4.1 : Card Positions and Channel Numbers

| Minitrend GR | | |
|----------------------|---|---------------------------------------|
| Slot position | Card type | Channel numbers |
| Slot A | 8 Analogue In Pulse Inputs | 1 to 8 1 to 4 |
| Slot B | 8 Analogue In Pulse Inputs 4 Analogue Out | 9 to 16 9 to 12 9 to 12 |
| Slot G | 4 Relay Output 8 Relay/2 Digital In 8 Digital Input/Output 16 Digital Input/Output | 1 to 4 1 to 8 1 to 8 1 to 16 |

| Multitrend GR | | |
|----------------------|---|--|
| Slot position | Card type | Channel numbers |
| Slot A | 8 Analogue In Pulse Input | 1 to 8 1 to 4 |
| Slot B | 8 Analogue In Pulse Input | 9 to 16 9 to 12 |
| Slot C | 8 Analogue In Pulse Input | 17 to 24 17 to 20 |
| Slot D | 8 Analogue In Pulse Input | 25 to 32 25 to 28 |
| Slot E | 8 Analogue In Pulse Input 4 Analogue Out | 33 to 40 33 to 36 33 to 36 |
| Slot F | 8 Analogue In Pulse Input 4 Analogue Out | 41 to 48 41 to 44 41 to 44 |
| Slot G | 4 Relay Output 8 Relay/2 Digital In 8 Digital Input/Output 16 Digital Input/Output | 1 to 4 1 to 8 1 to 8 1 to 16 |
| Slot H | 4 Relay Output 8 Relay/2 Digital In 8 Digital Input/Output 16 Digital Input/Output | 17 to 20 17 to 24 17 to 24 17 to 32 |
| Slot I | 4 Relay Output 8 Relay/2 Digital In 8 Digital Input/Output 16 Digital Input/Output | 33 to 36 33 to 40 33 to 40 33 to 48 |

| eZtrend GR | | |
|--------------------|------------------------|-----------------|
| Slot position | Card type | Channel numbers |
| Slot A | 3 Analogue Inputs | 1 to 3 |
| | 6 Analogue Inputs | 1 to 6 |
| Slot B option card | 6 Analogue Inputs | 9 to 14 |
| Slot G | 4 Relay Output | 1 to 4 |
| | 8 Relay/2 Digital In | 1 to 8 |
| | 8 Digital Input/Output | 1 to 8 |

| DR Graphic | | |
|--------------------|-------------------------|-----------------|
| Slot position | Card type | Channel numbers |
| Slot A | 4 Analogue Inputs | 1 to 4 |
| | 6 Analogue Inputs | 1 to 6 |
| | 8 Analogue Inputs | 1 to 8 |
| | 4 Pulse Inputs | 1 to 4 |
| Slot B | 6 Analogue Inputs | 9 to 14 |
| | 8 Analogue Inputs | 9 to 16 |
| | 4 Pulse Inputs | 9 to 12 |
| | 8 Relay/2 Digital In | 1 to 8 |
| | 8 Digital Input/Output | 1 to 8 |
| | 16 Digital Input/Output | 1 to 16 |
| | 2 Analogue Outputs | 1 to 2 |
| 4 Analogue Outputs | 1 to 4 | |

To fit the Analogue Input option card (Slot B) into the **eZtrend GR** recorder you will require an expansion card to interface to the recorder. See [“eZtrend GR Analogue Input \(Standard\) card” on page 32](#)

Analogue In Menu

(Main Menu > Configure > Setup > Edit Setup> Field IO > Analogue In)

For AMS2750 mode the Analogue In button will change to Sensors. Please refer to [“Sensors Configuration Menu \(Process Mode\)” on page 386](#)

Press the Analogue In button to display all the analogue inputs available.

Click on individual Analogue In number to set up each channel profile. Each channel has a list of menu items to be configured.

Refer to connection details and [“Analogue Input Channel Numbers” on page 30..](#)

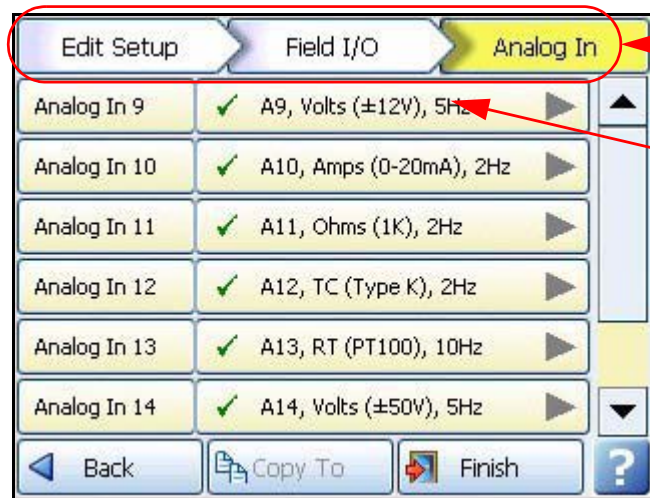

Menu path to current menu

The Analogue In screen displays all the available Analogue Input channels.

Each channel displays its' individual settings.

Select a numbered channel to edit the configuration of each input

- **Enabled** - Toggle On and Off.
- **Type** - Select this for a list of available Signal Inputs.
- **Sample Rate** - Select this for a list of available Analogue Input sample speeds. A Fast Scanning range of 50Hz (20ms) is available as a firmware option (not available for the **eZtrend GR** recorder). [See “Firmware Credit System” on page 241.](#) Arranged in 2 banks of 3 inputs, and sample rate must be the same within each bank, only for **eZtrend GR** recorder.
- **Range** (Ohms, Volts and Amps only) - Toggle between Preset and User Defined. The Preset option will make available a list of Range Types or select User Defined to specify High and Lower Limits.
- **Range Type** (Ohms, Volts and Amps only) - Only available when Range is set to Pre-set. Select for a list of available ranges. The factory default range is +/-12V. [See “User Defined Maximum Input Ranges” on page 304](#)
- **Damp Level** - The damping filter is an advanced algorithm offering improved response over more traditional methods. It works by producing configurable levels of damping - but at the same time being able to respond rapidly to large input changes. Enter the Damp Level in Engineering Units.

Figure 4.2 Effects of Damping and Rolling Average example

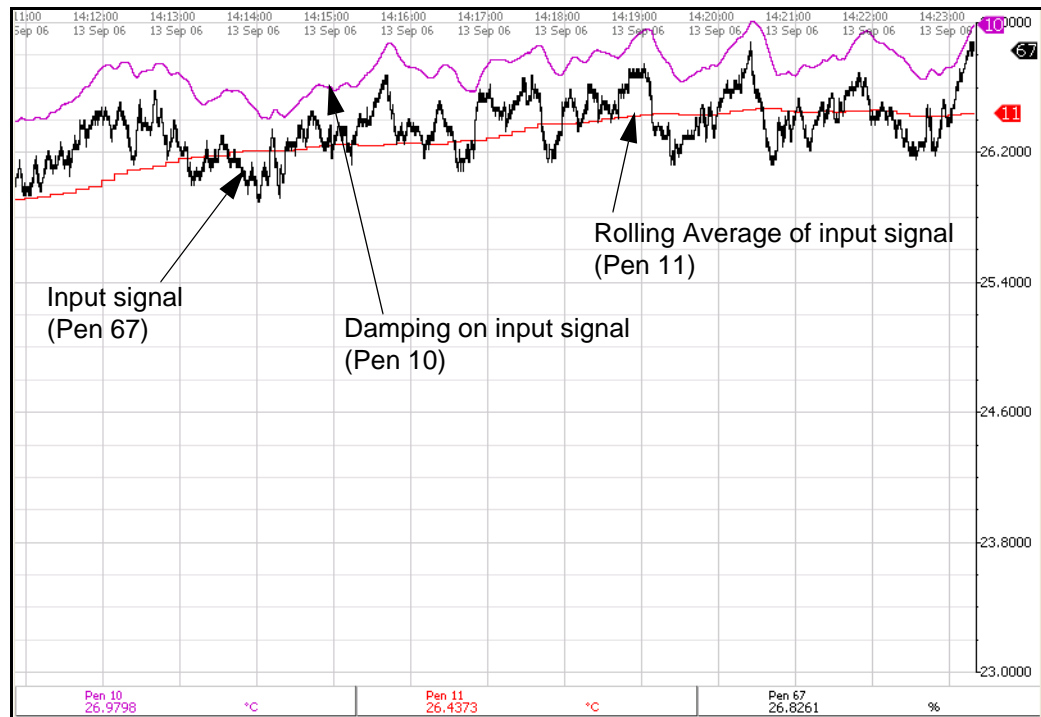

Note: the Damping (Pen 10) has been offset for this example to be able to see the damping effect clearly

- **Linearisation Tables** (Ohms, Volts and Amps only) - Select a table from the drop down list if required. See [“Linearisation Tables” on page 81](#).
- **Use Pen Scale** - Toggle On and Off, this is enabled by default. Analogue # defaults to the corresponding Pen #, eg. A1 will default to Pen 1. If you change A1 to display another pen scale eg. Pen 3, you must go into Pen 3 and change the maths to A1. This will ensure that Pen Scale 3 will display A1 input. With this enabled the Engineering zero and span is the same as the pen scale. Disable this and the Engineering zero and span will not reflect the pen scale. When disabled, see Eng. Span & Eng Zero bullet points below. This is not available when using Linearisation Tables.
- **Units** - (Ohms, Volts and Amps only). This is the Units of Measurement for each input. Select and enter a value. Max 13 characters. For Thermocouple and Resistance Thermometer units, see [“Localisation” on page 136](#).
- **Label** - Select and enter a identification label for the input. Select and enter a label. Max 15 characters.
- **SQRT Extract** - (Volts and Amps only). Toggle On and Off. The Square root extraction in the analogue input is used to linearise certain sensors that have a non linear output - for example in the calculation of flow. So when you check the Square root extraction in the Analogue input section it carries out the following calculation. It ratios the analogue input range that you set, to 0 to 1. So any sensor input is represented by a number from 0 to 1. We then take the square root. We then re ratio the result back to the user set range.

- **Sensor Comp** - Sensor Compensation may be required to improve accuracy on a sub range. This is an adjustment to the value of the signal input on each channel, based on the Engineering units settings. Choose from Single Point, Dual Point or Multi Point Cal, see [“Sensor Compensation” on page 351](#)
- **High Limit** - Available when Range is User Defined. Select and enter the high limit value.
- **Lower Limit** - Available when Range is User Defined. Select and enter the lower limit value.
- **RT Type** - Only available when Type is set to RT (Resistance Thermometer). Select this for a list of available RT types.
- **Burnout Type** - Only available when Type is set to TC (Thermocouple). Toggle between Active and Passive. Active means it will send out a current to the TC. Set to Passive means it takes a reading without sending out a current. The T/C is wired differently for Active and Passive Burnout (see [Figure , “Figure 2.16 Input signal wiring,” on page 31](#)). (Active Burnout is not available for the **eZtrend GR** recorder).
Active Burnout checks the health of the thermocouples every 30 seconds, if your process requires continuous check of the thermocouples to see if they are in burnout you should use Passive Burnout. Active burnout is an implementation of thermocouple health and provides error warning messages for a range of thermocouple activity/failure conditions. Passive burnout does not provide any error warning messages.
If the thermocouple wiring changes and the channel is set to Active, select Passive and Commit the change. Then return to the menu and select Active and Commit the change to update burnout settings.
- **Show Burnout** - Only available when Type is set to TC. Toggle between Upscale and Downscale Burnout.
- **TC Type** - Only available when Type is set to TC. Select this for a list of available TC types.
- **CJ Comp** - Only available when Type is set to TC. Select this for a list of available CJ Compensation. See [“Thermocouple CJC Compensation” on page 338](#).
 - **Int Automatic** - Uses the cold junction sensor in the recorder as a variable reference temperature
 - **Ext 0 Deg C** - Assumes the cold junction is held at 0° C to provide a 0mV reference, external to the recorder
 - **Ext with Spec Temp** - Uses a reference junction held at a constant temperature. Specify the temperature that the cold junction sensor is to be set at.
 - **Ext Input** - Use a thermocouple or resistance thermometer from another channel to measure the cold junction sensor
- **External Input** - Only available when CJ Compensation is set to Ext Input. Select the input required as an external input.
- **Eng. Span** - (Ohms, Volts and Amps only). Only available when not using “Use Pen Scale” option. This is the highest value of the engineering range and corresponds to the top of the input range. Select and enter a value using the on-screen keyboard.
- **Eng. Zero** - (Ohms, Volts and Amps only). Only available when not using “Use Pen Scale” option. This is the bottom of the engineering scale and represents the bottom of the input scale. Select and enter a value using the on-screen keyboard.
- **Demo Setup** - Only available if there is no Analogue Input card fitted. Examples of various inputs are available without having an actual signal input coming into the recorder.

- **Demo Type** - Select this for a list of available Demo Type inputs.
- **Cycle Time** - Enter the Cycle Time, in seconds, of the Demo Input. Select and use the on-screen keyboard.
- **Add Noise** - This is to Add Noise to the Demo Input as a percentage value. Select and use the on-screen keyboard.

When the configuration is complete select the Finish button to Commit, Discard or Commit Later. Select the Back button to return to the previous menu.

*Thermocouple Wiring Changes.

If the recorder is set to Active, select Passive and Commit the change. Then return to the menu and select Active and Commit the change.

Analogue Out Menu

(Not available for the eZtrend GR recorder).

(Main Menu > Configure > Setup > Edit Setup> Field IO > Analogue Out)

Only available when an Analogue Out card is fitted as an option, 2 or 4 outputs are available per card.

The outputs are factory calibrated to meet the published specification and cannot be field calibrated.

Refer to connection details and [“Analogue Output Channel Numbers” on page 35](#)

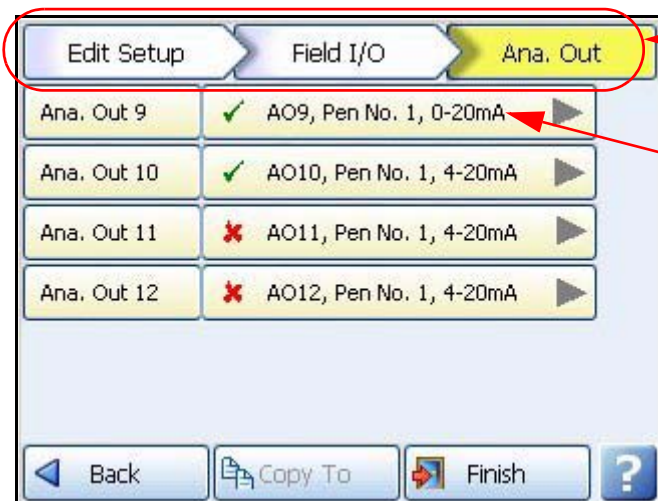

Menu path to current menu

The Analogue Out screen displays all the available Analogue Output channels.

Each channel displays its individual settings.

Select a numbered channel to edit the configuration of each output

Press the Analogue Out button to display all the analogue outputs available. Click on individual Analogue Out number to set up each channel profile.

- **Enabled** - Toggle On and Off.
- **Allow Overrange** - Toggle On and Off. Disabled as default, this will allow the output signal to go overrange to 21mA, if disabled the maximum is 20mA.
- **Transmit Pen** - Eg. Select a pen to output 4-20 mA loop. This will take the scale value from the pen it is transmitting and convert to 4-20mA output signal. eg if the scale is 0-50% this signal will fit the scale so 4mA = 0% and 20mA = 50%. For 0-20mA output signal with the same 0-50% scale, this would read 0mA = 0% and 20mA = 50%.

- **Output** - Select either 4-20mA or 0-20mA.
- **Label** - Select and enter an identification label. Select and use the on-screen keyboard. Up to 16 characters.

When the configuration is complete select the Finish button to Commit, Discard or Commit Later. Select the Back button to return to the previous menu.

Alarm / Digital IO

(Main Menu > Configure > Setup > Edit Setup> Field IO > Alarm/Digital IO)

The Alarm/Digital IO button will display all the digital inputs/outputs available. Click on each individual Alarm IO or Digital IO number to set up each channel profile.

Cards available are:

2 types of Alarm Relay cards

- 4 Alarm Relay Output
- 8 Alarm Relay Output with 2 Digital Inputs

2 types of Digital IO cards

- 8 Digital Inputs or Outputs
- 16 Digital Inputs or Outputs. (Not available for the **eZtrend GR** recorder).

Alarm Relay Card

4 Alarm relay output card or 8 Alarm relay Output with 2 Digital Inputs (6 fixed outputs and 2 configurable Digital Input or output) cards.

Digital IO Card

There are 8 or 16 Digital channels per card that can be setup as inputs or outputs. The Digital I/O card also has 4 channels that can be set as pulse inputs (channels 1 to 4). The operating frequency for pulse inputs on the Digital I/O card is 1kHz max.

Input: Low < 1V, High >4.5V to <10V DC (9V to 20V p-p AC) or Volt free input: Low = short circuit, High = open circuit.

To view and log a channel selected as a Pulse input, set up an extra pen with a Maths function of LPULn in Edit Maths in the Pens menu. For more information see [“Appendix B: Maths Expressions” on page 321](#).

For connection details see For connection details [See “Alarm Relay Channel Numbers” on page 39](#)

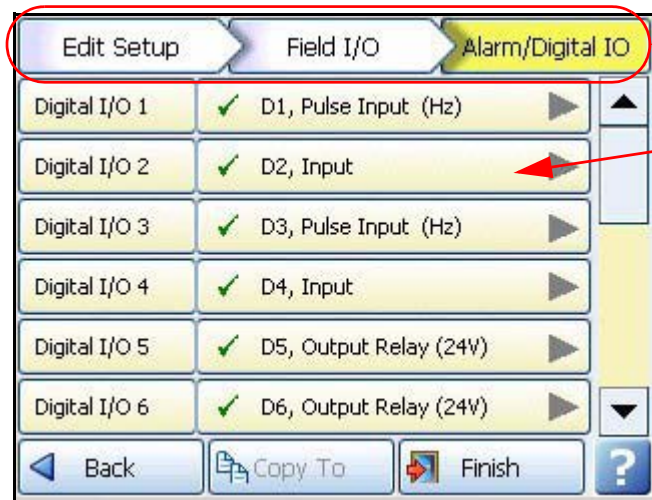

Menu path to current menu

The Digital IO screen displays all the available channels that can be set up to be digital inputs or outputs.

Each channel displays its individual settings.

Select a numbered channel to edit the configuration of each input or output.

For all cards select an Alarm/Digital # to display the configuration menu. Each Alarm/Digital has a list of menu items to be configured.

- **Enabled** - Toggle On and Off
- **Digital Type** - Set to Output Relay contact (Power) for the Alarm Relay cards. Toggle between Input and Output or Pulse Input for the Digital IO card. On the 4 Relay Alarm card, only output type is available. Channels 1 to 6 on the 8 Alarm Relay card are outputs, channels 7 & 8 can be either inputs or outputs.
Note: Pulse Input only available on channels 1 to 4 for slot G, 17 to 20 for slot H and 33 to 36 for slot I.
- **Output** - (Output only). The relay outputs can be set to be either Latched or Single Pulse. A Latched relay will be maintained in its active state until the trigger source has returned to a non-alarm state (unless acknowledged). For Single Pulse the relay will go active for a period of time, specified by the user, then return to a non active state. The time out period remains independent of the length of time the active state remains. If the output is set to Single Pulse, when the alarm is activated the signal will display a single pulse for the duration set. See Pulse Duration. The alarm will trigger again when it goes back into an active alarm state.

NOTICE

Outputs that are set to Single Pulse should not be used as a part of a maths expression as it can cause spurious values.

- **Pulse Duration** - (Output only). Available when Single Pulse is selected as an Output. Specify the pulse length in seconds from 0.1 (100ms) to 6480 (108 minutes) in 0.1 second increments. Select and enter the pulse length.
- **Failsafe** - (Output only). Toggles On and Off. Each relay channel can be independently selected with the fail safe option. This will invert the state of the relay output. With Failsafe Off, normally open (NO) relays have open contacts when the power is off, and open contacts when there is no active alarm. The contacts will close when an associated alarm goes active. With Failsafe On, normally open relays have closed contacts when the recorder is powered on and there are no open active alarms, and the contacts open with an alarm active or when the power is removed. [See "Failsafe Relay Positions" on page 306.](#)

- 
- **Label** - Select and enter an identification label. Up to 16 characters.
 - **Active Label** - (Input and Output only). This is the label that is shown when an alarm becomes active. Select and enter a label. Not available for Pulse Input. Up to 12 characters.
 - **Inactive Label** - (Input and Output only). This is the label that is shown when an alarm becomes inactive. Select and enter a label. Not available for Pulse Input. Up to 12 characters.
 - **Reports To** - This will acknowledge the Alarm/Digital IO to a selected destination. Select User message to add the Digital IO occurrence to the messages list only. Select Mark On Chart to display the occurrence on a chart and to the messages list.

When the configuration is complete select the Finish button to Commit, Discard or Commit Later. Select the Back button to return to the previous menu.

Pulse Input

(Not available for the eZtrend GR recorder).

(Main Menu > Configure > Setup > Edit Setup> Field IO > Pulse Input)

Only available when a Pulse Input card is fitted as an option. The Pulse Input card operates up to a frequency of 25kHz max. See [“Pulse Input Channel Numbers” on page 36](#).

Input: Low < 1V, High >4V to <50V DC or Volt free input: Low = short circuit, High = open circuit.

If a Pulse input card is fitted in slot A the first 4 pens will display the maths function of HPULn in Edit Maths in the Pens menu as default to display the pulse reading. For more information see [“Appendix B: Maths Expressions” on page 321](#).

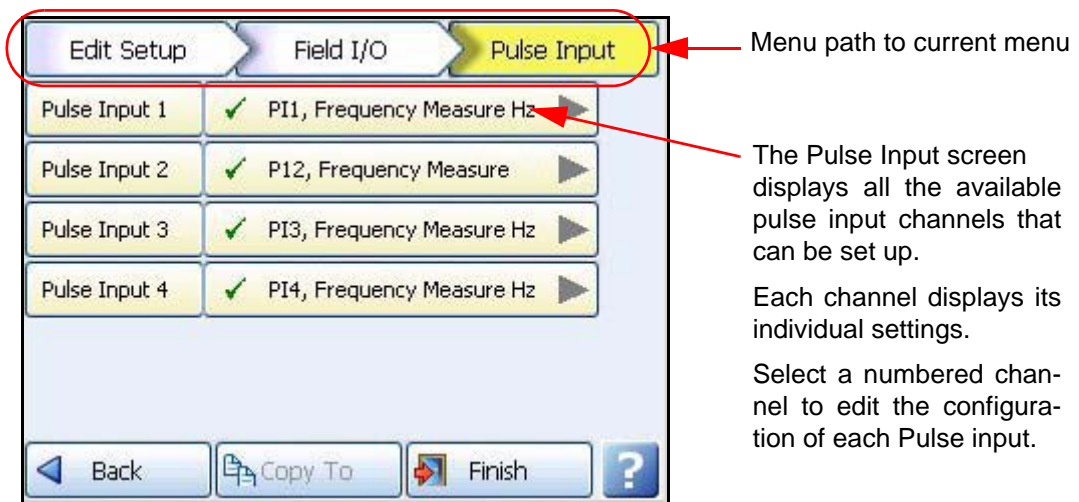

Press the Pulse Input button to display the available pulse inputs.

Click on individual Pulse Input number to set up each channel profile.

- **Enabled** - Toggle On and Off.
- **Hertz** - Fixed as Frequency Measure (in Hertz).
- **Update Rate** - Fixed at 1Hz
- **Label** - Select and enter an identification label for the pulse input. Select and enter a label. Up to 16 characters.

When the configuration is complete select the Finish button to Commit, Discard or Commit Later. Select the Back button to return to the previous menu.

Linearisation Tables

(Main Menu > Configure > Setup > Edit Setup> Field I/O > Linearisation)

Linearisation Tables - To be used with Analogue Input type Volts, Amps or Ohms. These are user defined tables that can be set up to allow a non-linear input signal to be displayed on the recorder. By entering a set of non-linear signal input values (X) into the linearisation table, the recorder will use the table to generate linear output (Y) in engineering units, to be displayed and/or log on the recorder.

- Select the next available table and rename it for ease of identification by selecting the name button.
- Select the Values button to take you to the start of a new table. Press the Add button to produce the first line. Up to 50 points are available in the table. More than one set of points are required to do the conversion.

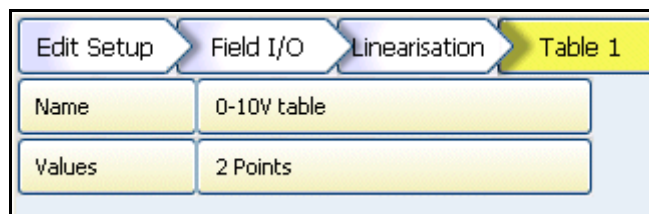

| | | | |
|------------|-------------|---------------|---------|
| Edit Setup | Field I/O | Linearisation | Table 1 |
| Name | 0-10V table | | |
| Values | 2 Points | | |

- Click into the text entry boxes under the X and Y boxes and enter the required values (or leave it if your table starts at 0). The Signal Input (X) goes in the first column and the Engineering units (Y) in the second column.
- To add a line at the bottom, click on Add. To add a line above or below, click on a line and use the Insert Above and Insert Below buttons. To delete a line, click in the line and select Delete.

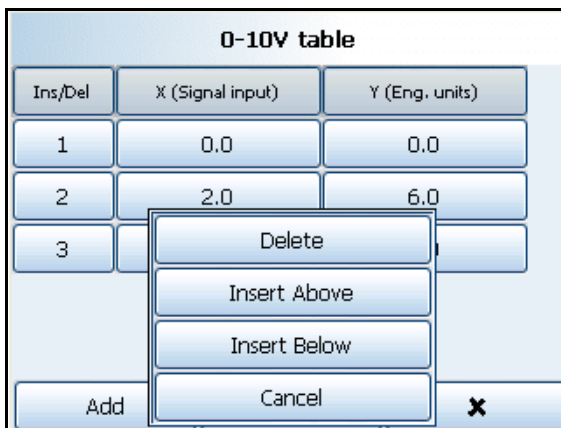

| 0-10V table | | |
|-------------|------------------|----------------|
| Ins/Del | X (Signal input) | Y (Eng. units) |
| 1 | 0.0 | 0.0 |
| 2 | 2.0 | 6.0 |
| 3 | | |

Context menu options: Delete, Insert Above, Insert Below, Cancel

Buttons: Add, Cancel, X

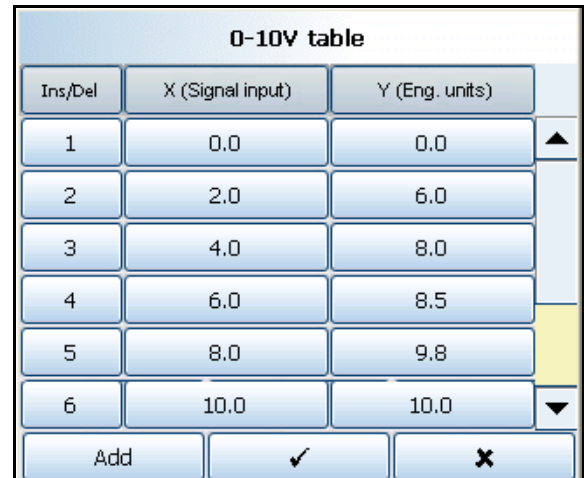

| 0-10V table | | |
|-------------|------------------|----------------|
| Ins/Del | X (Signal input) | Y (Eng. units) |
| 1 | 0.0 | 0.0 |
| 2 | 2.0 | 6.0 |
| 3 | 4.0 | 8.0 |
| 4 | 6.0 | 8.5 |
| 5 | 8.0 | 9.8 |
| 6 | 10.0 | 10.0 |

Buttons: Add, ✓, X

- When you have finished your table select the tick box, this will also verify the table and produce a Data Error box if there are any problems.

Data Error box

If incorrect vales are entered a Data Error box will appear saying "Data line * is invalid". This will appear when you select the tick box at the bottom of the screen. The error box will indicate which line has the error. There may be more than one error in the table, if so the data error message box will appear for each error starting from the top line down going to the next as each error is fixed.

Linearisation Table examples

Figure 4.3 shows an example of a set of non linear signal inputs (X) and the required values in engineering units (Y) that have been entered into a linearisation table. They would produce the following curve.

Figure 4.3 Example of a 0-10V non-linear input signal

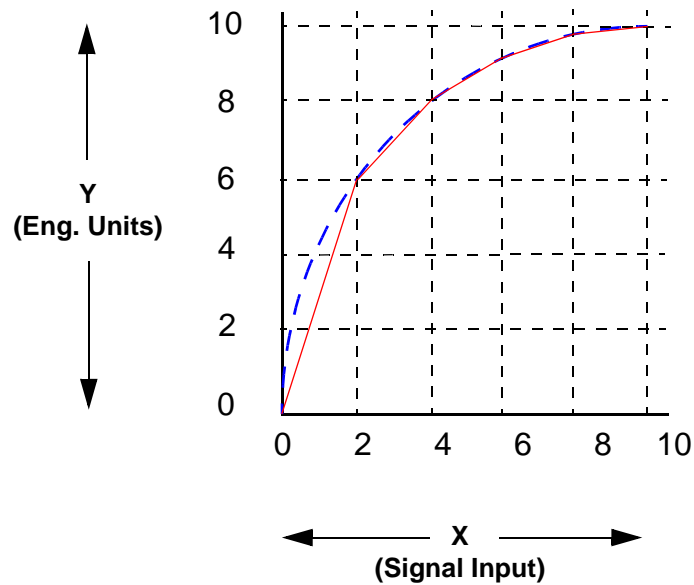

A straight line is drawn between each point, as shown by the continuous (red) line in Figure 4.3. For a more accurate curve, as shown by the dotted line (blue), add more data points into the linearisation table.

The Linearisation tables that you set up here can then be used in the [“Analogue In Menu” on page 73](#)

If the full input range is greater than the range used in the linearisation tables then the signal will carry on following the slope of the last two inputs. For example if we had a -50 to +50V range and just used the 0 to 10V linearisation table then the signal would look like Figure 4.4.

If the Analog input has been set to millivolts, and that the span is greater or equal to 1000 mV, then the linearisation table X values should be specified in Volts

Figure 4.4 Linearisation table used for part of the range

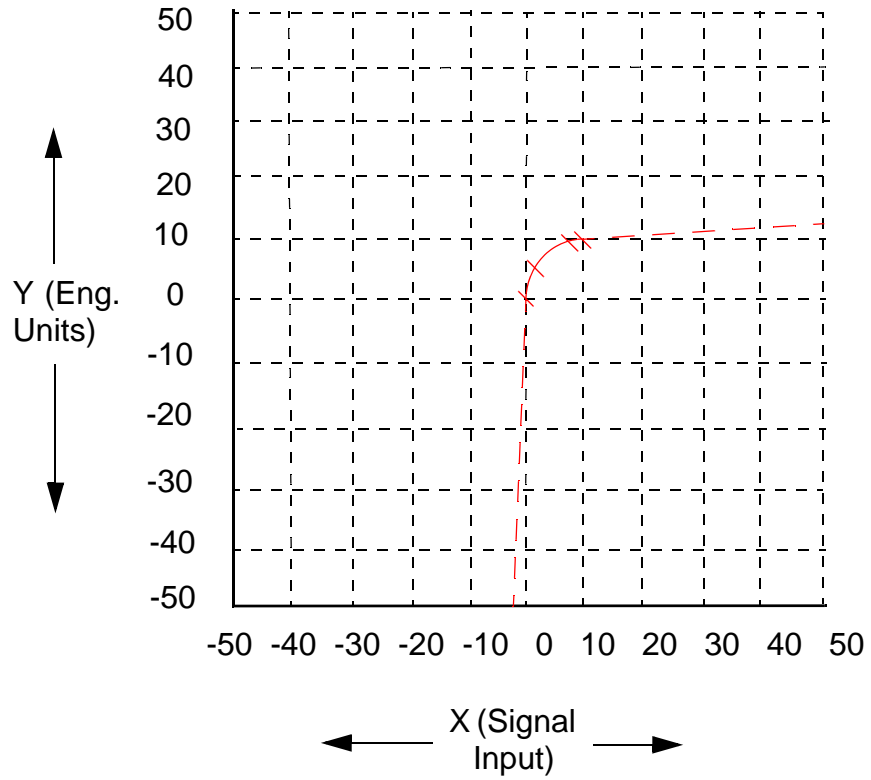

The last two points are used to follow the slope for the rest of the signal.
At the bottom of the 0-10V table the last two inputs are $X=0, Y=0$ and $X=2, Y=6$.
At the top of the 0-10V table the last two points are $X=8, Y=9.8$ and $X=10, Y=10$.
[Figure 4.4](#) shows these last two inputs at the top and bottom of the 0-10V signal.

Pens Menu

(Main Menu > Configure > Setup > Edit Setup > Pens)

Select the Pens button to display all the pens available.

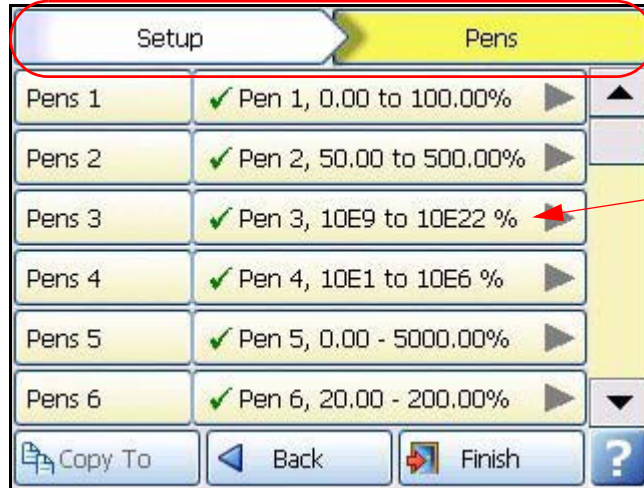

Menu path to current menu

The Pens screen displays all the available pens.

Each pen displays its scale settings.

Select a pen number to edit the setup of each pen including the Scale, Logging, Alarms and Totaliser

Click on individual pen number to set up each pen profile.

- **Enabled** - Toggle On and Off.
- **Tag** - Select and use the on-screen keyboard to type in an identifier for the pen. Up to 47 characters.
- **Description** - (Screen Designer screens only) Enter a screen description in this field that will then be displayed on the Screen Designer screen.
- **Maths Type** - Analogue signals may have a mathematical calculation performed on them before they are represented as a pen. Basic maths is standard in all recorders. Full Maths or Math Scripting are options that must be activated. [See "Options" on page 196.](#)
- **Edit Maths** - Edit the Maths for this particular pen. For details see ["Appendix B: Maths Expressions" on page 321.](#)
- **Scale** - Select Scale to go to a sub menu to set up the scale parameters. [See "Scale Menu" on page 85](#)
- **Logging** - Select Logging to go to a sub menu to set up the logging configuration. [See "Logging Menu" on page 86](#)
- **Alarms** - Select Alarms to go to a sub menu to set up the alarm profile. [See "Alarms Menu" on page 88](#)
- **Totaliser** - Select Totaliser to go to a sub menu to set up the totaliser settings. [See "Totaliser Menu" on page 90](#)
- **RAV** - This will display the Rolling Average for this pen. The recorder takes an average of the number of samples entered.
For example: a 1 hour rolling average made up of 1 minute averages it would be 60 seconds per sample with 60 samples, and you can increase the time span accordingly, so 1440 samples at 60 seconds per sample would give you a 24 hour rolling average made of 1 minute averages.
Enable the RAV function. Enter the **Number of Samples**.
Then enter the **Sample Interval**, or how often a reading is taken, in seconds.

Prefill works as follows, if you setup a 60 sample rolling average a 10 second samples that will create a 10 minute rolling average, with each sample being accumulated as an average from the current recorder processing rate (10Hz say), so each 10 second sample is added to a queue of 60 samples, and each 10 seconds the new rolling average is calculated. The prefill simply takes the current pen value and fills the queue with that average, causing the "damping" effect to be baselined at the current reading. No prefill will cause the first few samples to have a greater effect on the average, as they will not be diluted by 60 samples but 1, 2, 3, 4 up to 60 after the 10 minutes.

Group - This pen can be allocated to a Group with other pens to display information, be used for batch control or run reports on groups of pens. Select this to display the list of available Pen Groups. If you select a group here this pen will be added to it. Maximum 24 pens per group for **Multitrend GR**, 16 for **DR Graphic** and **Minitrend GR** and 8 for **eZtrend GR**. The group can then be renamed, to rename these groups, see ["Groups" on page 142](#). Groups are used as a part of the Batch system, see ["Batch Menu" on page 138](#).

Groups are also used as a part of AMS2750, see ["AMS2750 Process Menu" on page 379](#).

- **Colour** - Each Pen has a Default Pen Colour but this can be changed if required. Select and use the colour palette to set the pen colour.
- **Trace Width** - Select and set the Trace Width for this pen when it is displayed on a chart. The default trace width is 1 with a maximum of 7.

When the configuration is complete select the Finish button to Commit, Discard or Commit Later. Select the Back button to return to the previous menu.

Scale Menu

(Main Menu > Configure > Setup > Edit Setup > Pens > Scale)

Individually configure each scale per pen in the scale menu.

Menu path to current menu

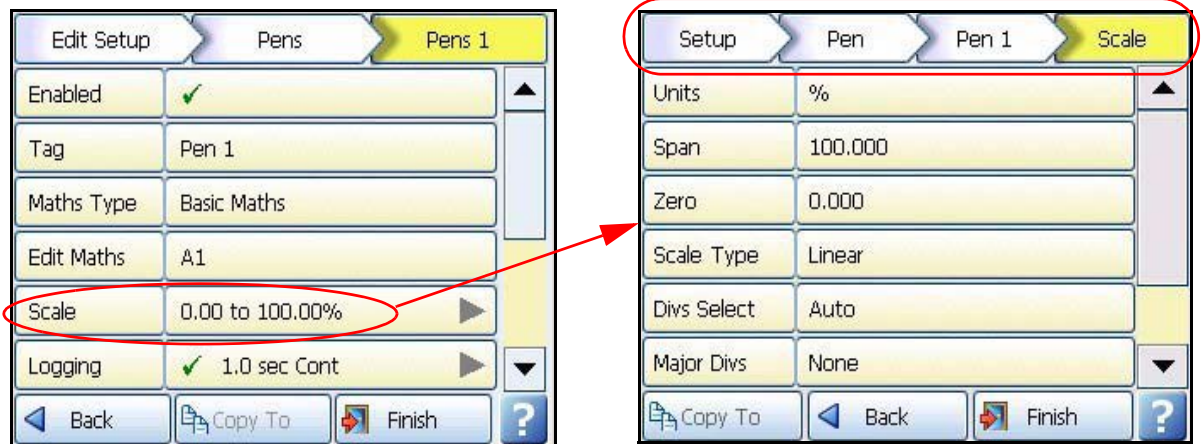

Select the Scale button to take you to the Scale menu

Click on Scale to set up each scale profile per pen.

- **Units** - Scale measurement Units. Select this and enter the units. Up to 16 characters.
- **Span** - This is the highest value of the scale. Select to enter the Span value.

- **Zero** - This is the bottom of the scale. Select to enter the Zero value.
- **Scale Type** - Toggle between Linear or Logarithmic (Log).
- **Divs Select** - Only available with Linear Scale Type. Toggle between Auto or User Defined.
- **Major Divs** - Only available when Divs Select is set to User Defined. Select and enter the major division position.
- **Minor Divs** - Only available when Divs Select is set to User Defined. Select and enter the minor division position.
- **Start Decade** - Only available when the Scale Type is set to Log. Select and enter the start value of the first decade.
- **No. Decades** - Only available when the Scale Type is set to Log. Select and enter the number of decades required. Max 99 decades (although not all will be displayed on the recorder).
- **Numb Format** - Displays the Notation of the number format, Scientific or Normal.
 - **Notation** - Toggle between Scientific or Normal number format. The scientific format displays the value to the power of 10 shown here. Notice the value has been rounded up.
 - **Auto** - Toggle Between Automatic number formatting and User Defined.
 - **After Decimal** - Only available when User Defined is selected. Select and enter the number of decimal places. (up to 15 decimal places)

Pen 2
26.670
%

Normal

Pen 2
2.7e+01
%

Scientific

When this pen setup is complete go back to the Pen # menu and complete the pen setup for all other pens.

Logging Menu

(Main Menu > Configure > Setup > Edit Setup> Pens > Logging)

Menu path to current menu

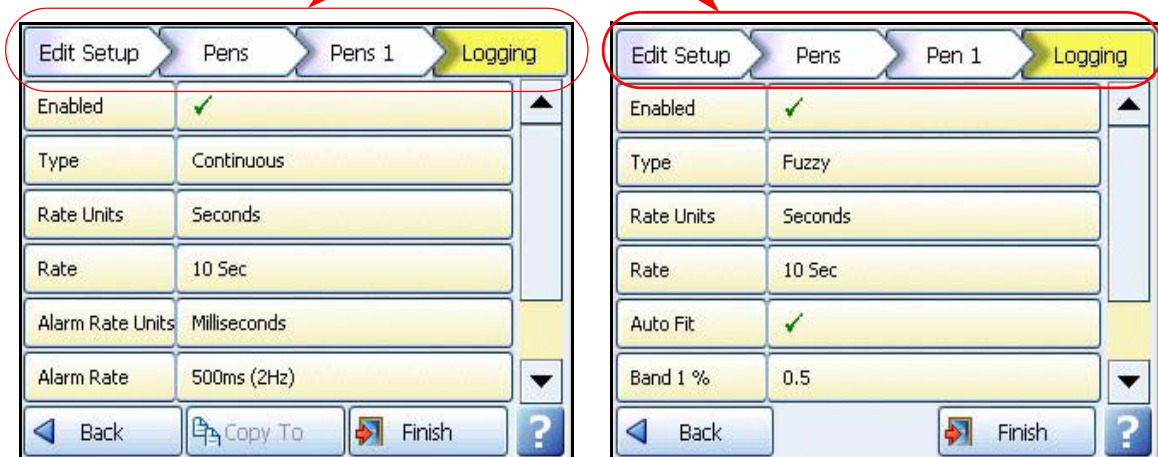

Pen Logging can be set to log as Continuous or Fuzzy

Click on Logging to set up each logging profile per pen.

- **Enabled** - Toggles On and Off to activate or de-activate logging for this pen.
- **Type** - Toggles between Continuous or Fuzzy logging. Continuous logs every value based on the Method chosen (Sample, Average or Max/Min).
Fuzzy Logging has been developed as a secure data storage technique which has a self teaching data storage algorithm so the recorder stores data at a variable rate to match the process being monitored. Fuzzy Logging has intelligent resources to enable the most effective and efficient way of using the scan rate, storage capacity and recording time. [See “Appendix F: Fuzzy Logging” on page 345](#)
- **Rate Units** - Set the Units for the logging rate to be displayed. Select and choose the logging rate units from the drop down menu.
- **Rate** - This is the speed at which data is required to be logged.
If the Millisecond option is selected as the **Rate Units** for the logging, then a drop down menu of options will appear. When all other **Rate Units** are selected a keypad will appear for user entry. Fastest rate is 20mS and slowest is 60 hours.
- **Alarm Rate Units** - Only available if the logging Type is set to Continuous. Set the Units for the Alarm logging rate to be displayed. Select and choose the alarm logging rate units from the drop down menu.
- **Alarm Rate** - Only available if the logging Type is set to Continuous. This is the new logging rate used when this pen goes into an active alarm state. To enable this feature to change the logging rate in an alarm state, see **Change Log** in the Alarms menu.
If the Millisecond option is selected as the **Alarm Rate Units** for the logging, then a drop down menu of options will appear. When all other **Alarm Rate Units** are selected a keypad will appear for user entry.
- **PreTrigger** - activate pre-triggering for that pen, any alarm on that pen will cause the pre-trigger system to be activated. Only the first 16 pens can be configured for pre-triggering.
For details on the Pre-Trigger function and configuration for the pre-trigger time is held in the recording menu in the setup configuration under a separate button called pre-trigger, [“Pre-Trigger” on page 151](#).
The alarm rate for each pen will be used for the pre trigger rate. The alarm rate must be set to less than 10 seconds per sample for pre-triggering to operate.
Pre trigger will only operate when the logging is in continuous sample mode, pre-triggering will not be available with fuzzy logging or Max Min.
- **Method** - Only available if the logging Type is set to Continuous. Select from a list of Methods.
Sample: logs the last sampled reading.
Average: logs the average of all the samples taken since the last log.
Max/Min: logs the highest and the lowest of the sampled readings since the last log.
- **Align** - Only available if the logging Type is set to Continuous. Select and enter a value from the list to align the logging at specified intervals. This will hold the start of logging until the aligned time selected occurs based on the recorders real time clock.
- **Auto Fit** - Only available if the logging Type is set to Fuzzy. Toggles On and Off. AutoFit ensures that the last sampled data point is logged before the signal goes out of the tolerance set in Band 1 or Band 2. When displayed on a graph, the input signal will automatically fit to this last logged point. This gives a better fit for stepped input changes.

- **Band 1 %** - Only available if the logging Type is set to Fuzzy. This is where the tolerance is set for the input signal. Specify, as a percentage of the scale range, the tolerance band allowed above and below the input signal. Select and enter a value.
- **Fuzzy Band 2** - Only available if the logging Type is set to Fuzzy. Toggles On and Off. This is to enable a second tolerance to be set, configure it to be On to activate. Only used in conjunction with Autofit On, to specify the Band 2 %.
- **Band 2 %** - Only available if the logging Type is set to Fuzzy. This is where a tighter tolerance can be specified which must be set within the limits of Band 1. Specify, as a percentage of the scale range, the tolerance band allowed above and below the input signal. Select and enter a value.

When the setup is complete go back to the Pen # menu and complete the pen setup.

Alarms Menu

(Main Menu > Configure > Setup > Edit Setup> Pens > Alarms)

This is for setting up alarms on this pen only, a maximum of 6 alarms per pen are allowed. Select the first available alarm eg. Alarm 1 and configure each alarm.



The Pen Alarms screen displays up to alarm set points per pen.

Each alarm displays its individual alarm setting.

Select an alarm number to edit the setup of each alarm

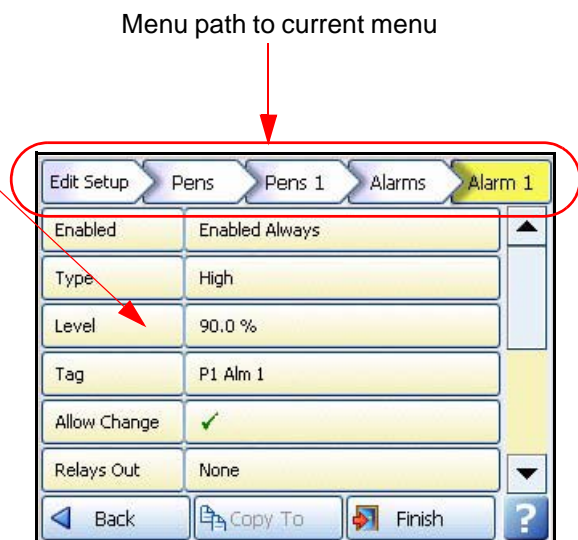

When an alarm has been configured an Alarm Marker or Pen Pointer will appear for each alarm depending on the type of process screen. [See "Alarm Markers" on page 236](#)

- **Enabled** - Select Enable to see a list of ways to enable or disable the alarm. Disable, Enabled Always or Dig Enabled.
- **Enabled by Digital** - Only available when Enabled is set to Dig Enabled. Select and choose which digital signal(s) will enable this alarm (on this pen only).
- **Type** - Select this to display a list of different types of Alarms. High, Low, Deviation, Rate Up or Rate Down. Set a High alarm to activate when the signal goes above the Alarm Level, or set a Low alarm to activate when the signal goes below the Alarm Level. Deviation is the how far this pen can deviate from the Ref Pen before triggering

an alarm. See Deviation Level and Ref Pen.

Rate Up and Rate Down Alarms are used to trigger an alarm when the signal changes a defined amount over a specified time. See Deviation Level and Time Period.

- **Level** - Select and enter a figure at which the alarm is to be triggered.
- **Deviation Level** - Only available when Alarm Type is set to Deviation, Rate Up or Rate Down. Select and use the numeric keypad to enter the amount of deviation (in engineering units). For Deviation enter the amount of deviation allowed on a designated pen (Ref Pen) before an alarm is triggered.
For Rate Up and Rate Down enter, as a percentage, how far the signal can deflect before an alarm is triggered.
- **Ref Pen** - Only available when the Alarm Type is set to Deviation. Select and enter the pen that this alarm is referenced to. This works like an actual pen that dynamically tracks a designated pen.
- **Time Period** - (Only available when the Alarm Type is set to Rate Up or Rate Down). Enter (in seconds) how long the signal is allowed to deviate, at the specified deviation level, before an alarm is triggered.
- **Tag** - Enter a tag or name to identify this alarm. Up to 17 characters.
- **Allow Change** - If activated this will allow quick configuration changes to this alarm level from the Alarms > Configure button on the Main Menu.
This does not change the original setup.
- **Relays Out** - Select and choose which Relay Output(s) is triggered by this alarm (on this pen only). The Fixed button will use the common relay output on the power board (24V relay). (Common relay output is not available for the **eZtrend GR** recorder).
- **Latched** - A latched alarm will maintain in its active state until the trigger source has returned to a non-alarm state and the alarm has been acknowledged. A latched alarm will continue to flash, if an alarm marker or pen pointer is displayed, until it is acknowledged and in a non-alarm state. [See “Acknowledging Alarms” on page 341](#) A Reflash option is available to keep the alarm flashing whilst in an alarm state even after it has been acknowledged. See **Reflash**.
- **Change Log** - Toggles On and Off. Select this to change the Log speed when an alarm occurs. The Log rate changes when alarm is active and stays at the alarm rate for as long as the alarm is active then returns to the normal logging rate. Set up the new alarm logging rate in **Alarm Rate** in [“Logging Menu” on page 86](#).
- **Mark Chart** - Toggles On and Off. Selecting On will place a Mark on the Chart with automated messages when the alarm becomes active. From the position of the Mark on Chart the chart background colour will change to show it is in an alarm state.
- **Email Alarm** - Enable this to send an email when any alarm is triggered on this pen. This function is a firmware option that is activated from the Factory menu > [“Credits” on page 131](#).
- **Recipients** - Only available when email has been enabled. Select your recipients from the list provided. Email addresses and Server names must be entered in [“Email” on page 106](#).
- **Hysteresis** - (not available for Deviation). Toggles On and Off. When this is activated, you can set a tolerance level for an alarm. It allows a specified percentage value of the span of the scale to be added to the alarm level.
- **Hyst Level %** - (not available for Deviation alarm). Enter as a percentage of the span of the scale. This is how much tolerance the signal can have past the set alarm activation

point until the alarm is de-activated. The example in [Figure 4.5](#) shows the alarm activating at 40% which is the set low alarm level. The alarm is not de-activated until the signal is at 50%, which is 10% past the set alarm level. So the **Hyst Level %** would be set to 10%. Reverse the process for a high alarm.

- **Damping** - Toggles On and Off. Damping is a time delay that works going into alarm only. When switched On, the alarm level must be breached for a specific period of time before an alarm is triggered.
- **Damping Time** - Set the amount of Damping time in seconds. Damp level can be from 1 seconds to 64800 seconds.
- **Reflash** - Toggles On and Off. Activate this to re-enable an active alarm that has been acknowledged. Set the Reflash Time.
- **Reflash Time** - Only enabled when Reflash is active. Set the time period after the alarm has been acknowledged for the alarm to reflash if it is still in an alarm state.

When the setup is complete go back to the Pen # menu and complete the pen setup.

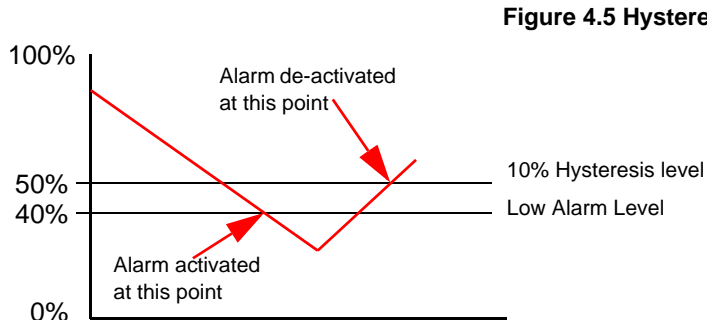

Totaliser Menu

(Main Menu > Configure > Setup > Edit Setup> Pens > Totaliser)

The Totals option must be active to use this option. See [Table 7.1, "Firmware Options," on page 241](#).

To Start, Stop, Reset and View Totals, see ["Totals" on page 190](#).

The Totaliser function is normally associated with flow monitoring applications. The input to the recorder would be a measure of flow rate (eg. In litres per second) and the total amount that has flowed over a specified time period. Multiple totalisations are possible with the use of extra pens (firmware Credit option). Totalisation values are 10 digits plus exponent.

NOTICE

IEEE floating point numbers with large unit factors beyond the IEEE range may incur incremental errors, specially if incrementing by a small amount each time. If this is your type of application a work around would be to set the Unit factor to 1 and then divide the total by your original unit factor.

Click on Totaliser to set up the totalising profile per pen.

Totaliser menus showing Normal and Sterilisation types

Menu path to current menu

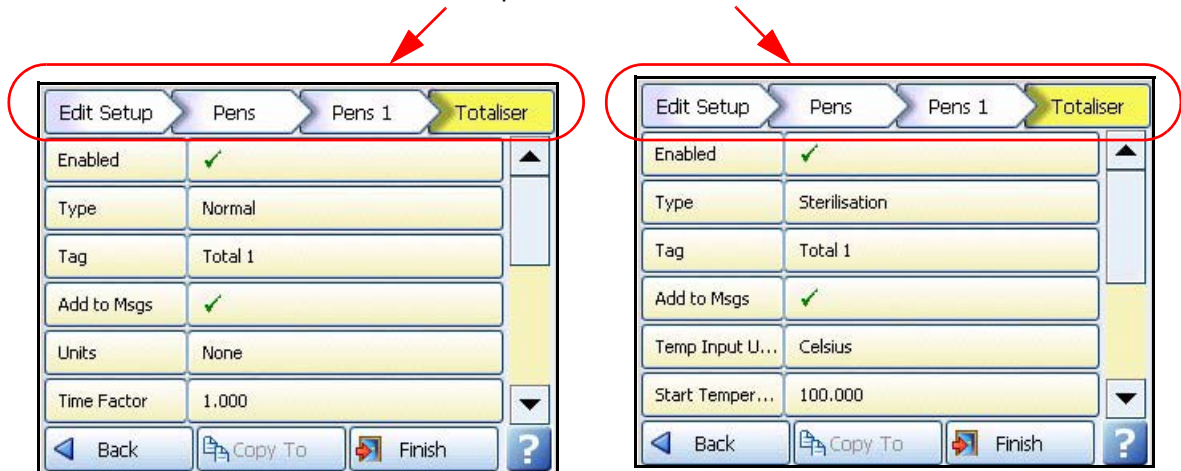

Select Totaliser from the Pen screen to display the totalising setup menu

- **Enabled** - Toggles On and Off to activate or de-activate totalising for this pen.
- **Type** - Select this for a list of Types of totalising. Normal or Sterilisation. Normal totaliser function is usually associated with flow monitoring applications. Sterilisation* is where items are subjected to heat over a period of time. Each pen can be totalised according to the Fo or Po sterilisation* function at 250 °F (121.11°C). The Standard Reference Temperature and Thermal Resistance (Z Value) are adjustable. All temperature limits are adjustable. Start temp, Reference temp and Z factor are all user defined, allowing support for many different types of sterilisation applications. [See "Sterilisation" on page 93](#)
- **Tag** - Select and enter an identifier for the pen. Up to 17 characters.
- **Add to Msgs** - Toggles On and Off. Select this to add a totaliser to the messages screen. Eg. Total1: Total 1 Reset
- **Units** - Normal Totaliser only. This is the Units of Measurement for the totaliser. Select and enter the units. Up to 12 characters.
- **Time Factor** - Normal Totaliser only. Time factor – Totaliser adds a value once per second, so you need to Divide by this factor. For example:

If your flow meter is in units/second Time factor is 1.

If your flow meter is in units/minute, the unit will DIVIDE by the time factor, in this case 60 – so every 1 second, 1/60th of the unit is added.

If your flow meter is in units/hour, the unit will DIVIDE by the time factor, in this case 3600 – so every 1 second, 1/3600th of the unit is added.

- **Unit Factor** - Normal Totaliser only. The Totaliser adds the engineering unit from the instrument, onto the total (after the time factor is applied). You then need to Divide by the unit factor. For example:

If your flow meter is in litres/time and you want to Totalise in litres – there 1 litres in 1 litre, so your unit factor would be 1, so every 1 second 1/1 unit is added.

If your flow meter is in litres/time and you want to Totalise in Cubic meters – there are 1000 litres in 1 cubic meter, so your unit factor would be 1000, so every 1 second 1/ 1000th of a unit is added.

- **No Backflow** - Normal Totaliser only. If the flow reading should go into a negative value, eg. The flow meter has been switched off, and “No Backflow” is inactive, the totaliser will subtract from the total value. When “No Backflow” is active any negative values are ignored and the total value is held while the flow meter is off until the backflow level is exceeded.
- **Backflow Level** - Only active when No Backflow is set. Set the level at which totalising will stop if the signal flow goes below this limit and if the No Backflow option is active.
- **Restrict Range** - Normal Totaliser only. Toggles On and Off. When active the totaliser restarts at Min range once it reaches Max range.
- **Min. Range** - Normal Totaliser only. Only available when Restrict Range is active. Select and enter the minimum limit for the totals to range to.
- **Max. Range** - Normal Totaliser only. Only available when Restrict Range is active. Select and enter the maximum limit for the totals to range from.
- **Use Remainder** - Normal Totaliser only. Only available when Restrict Range is active. Toggles On and Off. If the total exceeds the maximum range set, the total will reset to the minimum range set. When Use Remainder is active, it will carry over any amount in excess of the maximum range set.
- **Temp Input Units** - For Sterilisation, select the temperature input units.
- **Start Temp** - For Sterilisation, select the Start Temperature.
- **Ref. Temp** - For Sterilisation, select the Reference Temperature.
- **Z Factor Temp** - For Sterilisation, select the Z factor temperature
- **Include Cooling** - For Sterilisation, Include Cooling if required
- **Completion Value** - For Sterilisation, if cooling is not required, enter a Completion Value. The totaliser will stop at this value.
- **Reset at 16M** - Enabled by default. The upper limit for the totaliser count is fixed to 16777215 to prevent an inaccuracy. The totaliser will get reset after this count. To go above the 16M limit disable this function, but be aware that the count will add some inaccuracies in the calculation above this upper limit, see [Table 4.2 on page 93](#).
- **Numb Format** - Displays the Notation of the number format, Scientific or Normal.
 - **Notation** - Toggle between Scientific or Normal number format.
 - **Auto** - Toggle Between Automatic number formatting and User Defined.
 - **After Decimal** - Only available when User Defined is selected. Select and enter the number of decimal places. (up to 15 decimal places)

When the setup is complete go back to the Pen # menu and complete the pen setup.

Sterilisation

*Specification for Sterilisation. The definition Fo/Po is the sterilisation/pasteurisation time in minutes required to destroy a stated number of organisms with a known z at temperature T. For example, "F18/250" represents the time in minutes required to destroy a stated number of organisms at a temperature of 250°F (121.11°C) with a z = 18 degrees °F. F values are used to compare the sterilizing values of different processes, however, F values cannot be compared unless the z values are the same. When temperature is not specified (for example, F = 8.6) it is understood that the temperature is 250°F (121.11°C); the subscript O (as in the term Fo = 7.4) is used to indicate that the z = 18 degrees F and the temperature is 250°F (121.11°C). See ["Appendix G: F sub zero Sterilisation" on page 349](#).

Displaying Totals

Totals can be displayed by setting up a separate pen to display the totalised value. Totals are best displayed in a DPM screen. If you use a separate pen to display a total be aware that if the total is stopped the pause symbol will not appear as it does for a totaliser pen.

First, select a pen you are going to use to display the total of another pen. Extra pens are available as a Firmware option see ["Credits" on page 131](#)). For this example this will be Pen 4. To Start, Stop, Reset and View totals, see ["Totals" on page 190](#).

In the pens menu for the totalising pen (Pen 4), select Edit Maths and enter "T" followed by the pen number you wish to totalise eg.T3. Pen 4 is now set to totalise the value of Pen 3.

It may be necessary to set a larger scale for the totalising pen (pen 4) as the totalising value may become larger than the pen scale of the pen being totalised (pen 3).

When the configuration is complete select the Finish button to Commit, Discard or Commit Later. Select the Back button to return to the previous menu.

Go to the recorder's process screen and select a screen showing DPMs. The totalising pen (pen 4) will display the totalising value of pen 3.

Rest at 16M

Accuracy table for totaliser count over 16 million (Totaliser menu "Reset at 16M" - disabled)

Table 4.2 :

| Exponent | Data Range | Loss in Recorder Precision (Accuracy Error) |
|-----------------|-------------------------|--|
| 23 | 8388608 – 16777215 | 0 |
| 24 | 16777216 – 33554431 | 1 |
| 25 | 33554432 – 67108863 | 2 |
| 26 | 67108864 – 134217727 | 4 |
| 27 | 134217728 – 268435455 | 8 |
| 28 | 268435456 - 536870911 | 16 |
| 29 | 536870912-1073741823 | 32 |
| 30 | 1073741824 - 2147483648 | 64 |
| 31 | 2147483648 - 4294967296 | 128 |

Comms Menu

(Main Menu > Configure > Setup > Edit Setup > Comms)

- **Services** - See [“Comms Services Menu” on page 101](#)
- **TCP/IP** - See [“TCP/IP” on page 94](#)
- **Network Admin** - See [“Network Admin” on page 98](#)
- **Load Certificates** - See [“Secure Communications” on page 100](#)

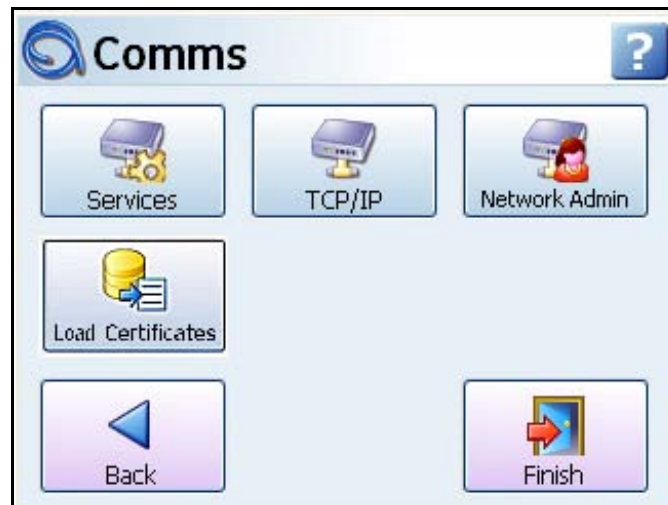

Services

Modbus, Web, Email, SNTP, FTP and Peers. See [“Comms Services Menu” on page 101](#)

TCP/IP

(Main Menu > Configure > Setup > Edit Setup > Comms > TCP/IP)

Transmission Control Protocol/Internet Protocol.

A protocol for communication between computers, recorders and other devices.

Automatic DNS Names - The recorder will automatically register a unique Network ID using the serial number. The format is **xs-nnnnnn**, where nnnnnn is the serial number of the recorder. This allows you to locate the recorder for browsing if you are using DHCP (Dynamic Host Configuration Protocol).

TCP/IP Settings

- **Static IP** - Toggle On and Off. With this enabled the IP address will be the same every time the recorder is powered up. With this feature Off, the recorder's IP address is created dynamically using a DHCP (Dynamic Host Configuration Protocol) Server. With this feature On the IP address can be fixed by entering a known available IP address. Preceding 0 should not be added when entering a Decimal Static IP address for example 192.168.015.019 must be entered as 192.168.15.19.

- **IP Address** - (Available when Static IP is On). This is an identification address for communications between two devices. The IP Address identifies a specific recorder. Please see [“Entering IP address details” on page 95](#).
- **Sub Net Mask** - (Available when Static IP is On). Acts as a filter when identifying an IP address. Please see [“Entering IP address details” on page 95](#).
- **Gateway** - (Available when Static IP is On). A configuration parameter transmitted to each network device. Please see [“Entering IP address details” on page 95](#).
- **DNS/WINS/MDNS** - Set to Automatic, click on this to activate and de-activate options. DNS = Domain Name System, WINS = Windows Internet Name Service, MDNS = Managed Data Network Services. See [“DNS/WINS/MDNS” on page 96](#). Please see [“Entering IP address details” on page 95](#).
- **Ports** - The Port numbers are associated with the IT system in use. Port numbers are set to a default but can be changed by the user to allow data traffic to use a specified port. See [“Ports” on page 96](#)

Entering IP address details

The IP Address in TCP/ IP Settings can be set in different number systems (Octal, Decimal, and Hexadecimal). The number system depends upon the leading character of each octave. (0x for Hexadecimal, 0 for Octal and decimal otherwise).

Using the SIP to enter the IP address, the number gets stored in a Decimal number system and will be displayed in decimal number system only.

Below left is the snapshot for octal representation of IP Address and to the right is the snapshot after it gets converted to decimal.

Octal IP address entered

Decimal IP address representation

The Address range that can be entered in different number system is as shown in Table 4.3 on page 95

Table 4.3 : Number systems

| | Minimum Value | | Maximum Value | |
|--|---------------|---------------|---------------|---------------|
| | Entered | Decimal Value | Entered | Decimal Value |
| | | | | |

Table 4.3 : Number systems

| | Minimum Value | | Maximum Value | |
|-------------|-----------------|-----------------|------------------|-----------------|
| | Octal | 000.000.000.000 | 0.0.0.0 | 077.077.077.077 |
| Decimal | 0.0.0.0 | 0.0.0.0 | 255.255.255.255 | 255.255.255.255 |
| Hexadecimal | 0x0.0x0.0x0.0x0 | 0.0.0.0 | 0xf.0xf.0xf.0xf. | 15.15.15.15 |

Remember: When entering a Decimal Static IP address no preceding 0 should be added for example 192.168.015.019 must be entered as 192.168.15.19.

The provision for Entering IP information in different number system is applicable for TCP/IP Address, Subnet Mask, Gateway, DNS and WINS.

DNS/WINS/MDNS

(Main Menu > Configure > Setup > Edit Setup > Comms > TCP/IP > DNS/WINS/MDNS)

Set to Automatic, click on this to activate and de-activate options. DNS = Domain Name System, WINS = Windows Internet Name Service, MDNS = Managed Data Network Services.

- **Auto DNS** - This is a sub menu for DNS/WINS/MDNS. Toggles On and Off. With this deactivated the DNS Server address can be changed from the default, if required.
- **Pri. DNS Address** - This is a sub menu for DNS/WINS/MDNS. Only available when Auto DNS is deactivated.
- **Sec. DNS Address** - This is a sub menu for DNS/WINS/MDNS. Only available when Auto DNS is deactivated.
- **Auto WINS** - This is a sub menu for DNS/WINS/MDNS. Toggles On and Off. With this deactivated the Windows Internet Name Service can be changed from the default, if required.
- **Pri. WINS Address** - This is a sub menu for DNS/WINS/MDNS. Only available when Auto WINS is deactivated.
- **Sec. WINS Address** - This is a sub menu for DNS/WINS/MDNS. Only available when Auto WINS is deactivated.
- **Auto MDNS** - This is a sub menu for DNS/WINS/MDNS. Toggles On and Off. This will deactivate the Managed Data Network Services.

When the setup is complete go back to the TCP/IP menu and complete the Comms setup.

Ports

(Main Menu > Configure > Setup > Edit Setup > Comms > TCP/IP > Ports)

The port numbers are associated with the IT system in use. Port numbers are set to a default but can be changed by the user to allow data traffic to use a specified port.

- **HTTP** - HyperText Transport Protocol is the communications protocol that enables Web browsing. Select and enter the desired port number if required. (Defaults to 80)
- **Modbus** - communications protocol used for automation applications. Select and enter the desired port number if required. (Defaults to 502)

When the setup is complete go back to the TCP/IP menu and complete the Comms setup.



When the configuration is complete select the Finish button to Commit, Discard or Commit Later. Select the Back button to return to the previous menu.

Network Admin

(Main Menu > Configure > Setup > Edit Setup > Comms > Network Admin)

This must be set up to ensure network printing can be performed, and emailing made easier, without being prompted for this information each time you want to print or email. This information will remain after a firmware upgrade.

Network Admin is required for printers on a network and shared or work group printers. Shared or work group printers must contain the correct file path, see [“Printer Menu” on page 141](#)

The Network Share Path (NAS) can be used for loading and saving layouts (.lay) and/or set-up files (.set), saving (exporting) reports, any messages (Diagnostic, system etc), loading sound files from this network share to recorder. This can also be used to print to file and this file can be saved to this network shared folder.

The use of the network folder for Scheduled export is not recommended since network connectivity and network problems could result in the risk of missing data due to the Scheduled export not being performed at the scheduled time and the folder not being updated.

Note. The network share folder cannot be used to upgrade firmware remotely. Firmware upgrade needs to be done locally using local USB or local SD card.



| | |
|----------------|-------------------------------------|
| Username | E505040 |
| Password | ***** |
| Domain | pacrim1 |
| Use Share Path | <input checked="" type="checkbox"/> |
| Share Path | \\ie67tcsj52bs\test\ |

Back Copy To Finish ?

- **Username** - Enter your network Logon/username
- **Password** - Enter your network password. For a local printer connected directly to the recorder via USB no domain is required. Ensure the printer name is set to the default (LPT1:), see [“Printer Menu” on page 141](#).
- **Domain** - For network printers enter your network domain. No domain is required for Local printers connected directly to the recorder via USB.
- **Use Share Path** - Check this to enable or disable the Share path
- **Share Path** - enter network path to folder
Note: Share Path Should be in “\\<Machine Name>\<Shared Folder Path>” Format.
Machine Name should not be IP address.

Share Path Access

This network shared folder must have Permission and Security rights (read for loading files) or write (for writing files) or both (for loading as well as writing files)) to access the shared path for each user. If the user does not have access rights to shared path then user will not be able to access shared path.

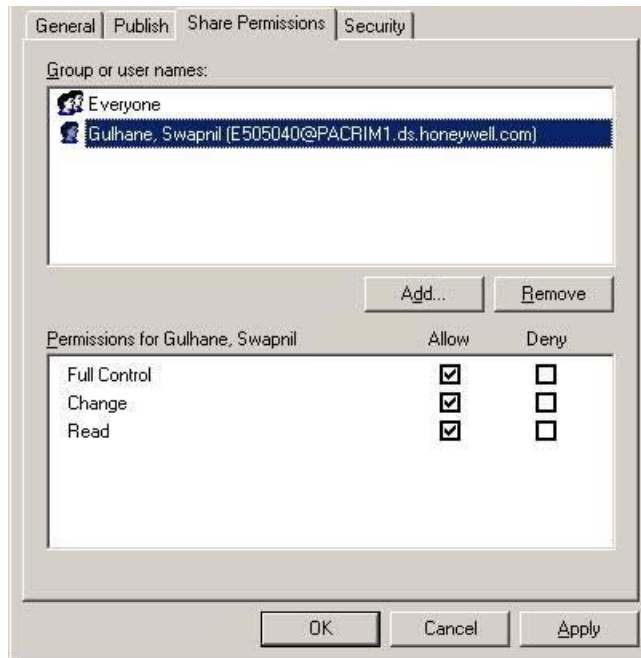

This must be done on a local pc or server where the user wants to have access for any particular folder. User (Administrator of local pc or server) needs to right click on any folder that needs access for any particular folder.

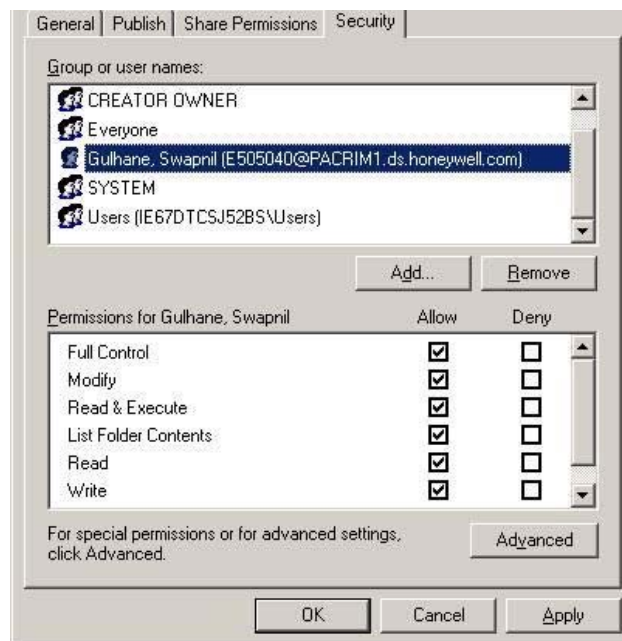

If in doubt, contact your IT Administrator for advice on entering Network Admin requirements.

Load Certificates

(Main Menu > Configure > Setup > Edit Setup > Comms > Load Certificates)

The Secure Comms certificate has already been uploaded into the recorder before leaving the factory. This button is only to be used if the certificate should need to be reloaded with assistance.

For any queries regarding certificates please see back page for contact details

Secure Communications

A Secure Comms certificate is required to host a secure web service. Secure Comms is a Credit Option. [See “Credits” on page 131.](#) The Secure Comms protocol uses WSD and can be used to transfer data to and from a recorder recorder. A Secure Comms certificate will be required for each recorder.

WSD (Web Services on Devices)

WSD is a web service that can run on devices and conforms to the Devices Profile for Web Services (DPWS). WSD web service can be secured with SSL certificates and can work over HTTPS.

Secure FTP

To ensure secure data upload in the **GR Series** recorders, WSD (Web Services on Devices) should be used with **GR Series** recorders. Recorder device will host web service and have server certificate installed on it. The **Trend Server** software, will have root authority certificate of server in trusted root certificates. Whenever **TrendServer** software connects to WSD service, SSL handshake will take place and on successful handshaking secure communication channel will be established and data flowing between these two end points will be encrypted. Only WSD clients with valid certificates can connect to WSD service. Data transfer between Recorder and **TrendServer** software will be in secure mode.

Comms Services Menu

(Main Menu > Configure > Setup > Edit Setup > Comms > Comms Services)



- **Modbus** - Communications protocol for Ethernet and RS485. [See "Modbus" on page 103.](#)
- **Web** -Browse your recorder using the web browse feature. [See "Web" on page 106.](#)
- **Email** - Setup email accounts to send alarm and event information. [See "Email" on page 106.](#)
- **SNTP** - Simple Network Time Protocols is a protocol for synchronising the clock on the recorder with a Network Server. [See "SNTP" on page 108.](#)
- **FTP** (File Transfer Protocol) - used to transfer data to and from the recorder. [See "FTP \(File Transfer Protocol\)" on page 109.](#)
- **Peers** - Sets up the recorder to be identified on a network (Peer to Peer). [See "Peers" on page 110.](#)

Standard Communication Interfaces

Rear Ethernet Communication Port

The rear of the recorder is fitted with an Ethernet10/100 port and RS485, except for the DR Graphic recorder which has these communication ports inside the recorder housing, which supports:

- RS485 Modbus protocol and TCP/IP Modbus.
- Web Browser. [See "Web" on page 106](#)

Rear RS485 Port

(Not available for the **eZtrend GR** recorder).

- RS485: 2 wire to support Modbus RTU.



The RS485 connector plugs into the back of the recorder. Recorders can be setup as either Master or Slave devices. See [“Modbus Master Communications” on page 103](#).

Front and Rear USB Communication Ports

The front and rear of the **Minitrend GR** and **Multitrend GR** recorders are fitted with a USB communication port. The **eZtrend GR** recorder has a USB port at the front, as standard.

2 USB ports for the **DR Graphic** are extended inside the case to a dual panel mount receptor above the power supply. USB peripherals/wires can be connected on the panel mount connector inside the case.

The USB Host ports will provide an interface for:

- Save and Load Data
- Save and Load Setups
- External keyboard & mouse
- Barcode reader
- Mass storage device (USB key)
- Local printer

Modbus

(Main Menu > Configure > Setup > Edit Setup> Comms > Comms Services > Modbus)

Modbus is available as a Firmware option see "[Credits](#)" on page 131).

Modbus can be used with the Ethernet or RS485 ports. The Modbus protocol defines a message structure that devices will recognise and use, regardless of the type of network over which they communicate. (RS485 is not available for the **eZtrend** recorder)

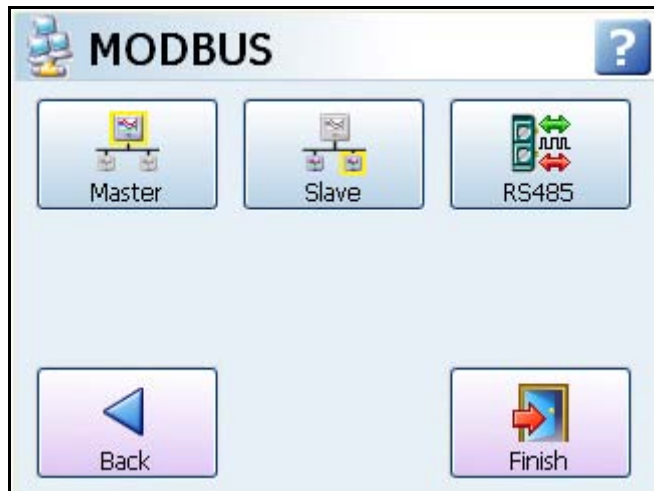

Modbus Master Communications

The recorder can communicate with up to 32 slave devices on both RS485 and/or Ethernet at a maximum poll rate of 1 second (slowest 1 hour). Each slave can perform up to 8 "transactions", where a transaction can retrieve or send 1 or more registers from a slave, or retrieve or send 1 or more Pens to a slave. When requesting multiple transactions it is recommended not to request more than 24 at one time to allow the recorder to process the information. So for 32 registers/pen values we would recommend 2 requests of 16 devices.

Access to slave registers within the maths function has been provided using SCV (Slave Comms Variable). For example SCV[x,y,z], where x = Slave number, y = Transaction Number, and z is the each successive register retrieved starting from 1 (Item).

The Modbus master can be used in conjunction with the Modbus slave functionality of the recorder to enable the recorder to act as a communications bridge. Data from the slaves connected to a Modbus master is made available as a map on the slave side of the Modbus master; this allows another master to get access directly to another master's slaves data without the master having to re-process that information. Or a Modbus master can process the data and expose it to the network as its own pens in Modbus.

Modbus master must be enabled as a firmware option and requires Full Math or Scripting to assign values to a pen, see [“Credits” on page 131](#).

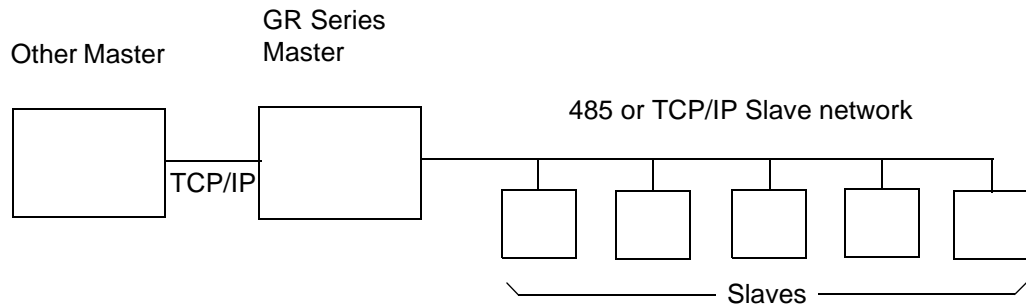

Full Modbus status can be viewed in [“Modbus Status” on page 204](#).

Refer to the Modbus Master Installation Instructions that are on the CD to help set up other modbus devices to talk to the recorder. (Instruction sheets 43-TV-33-89 - 43-TV-33-102).

Master

- **Enabled** - Toggle On to make this recorder a Master device
- **Poll Rate** - Enter a time period in seconds of how often there is a request for data
- **Legacy Ethernet** - Tick this to connect to **Honeywell V5** recorders.
- **Slave 1 ..32** - Up to 32 slaves can be setup per master device. Setup each Slave in turn starting with number 1.
 - **Enabled** - Toggle On to enable Slave #
 - **Friendly name** - Enter a name to easily identify this slave device
 - **ID** - This is to connect to slave ID
 - **Port** - Select this for a list of available ports, either Ethernet or RS485. For port configuration see [“Ports” on page 96](#).
 - **Network Name** - (Ethernet only). Enter the Modbus Slave IP address.
 - **Protocol** - Select this for a list of available protocols. Modbus or Modbus X*. Modbus and Modbus X can both use the Ethernet or RS485 ports. Protocols define the format in which the data is transferred from the recorder to a PC or transfer between other devices and peripherals. **FPLB** – Floating Point Little Endian Byte Swapped Format & **FP B** - Floating Point Big Endian Format are standard notations.
 - **Transaction 1 ..8** - A request for a register or set of contiguous registers
 - Enabled** - Toggle On to enable the first transaction request
 - Direction** - Direction for the data to flow; In to or Out from the recorder
 - Command** - This is the type of Registers used by the slave device. Refer to the individual memory map for the register type used for each type of device.
 - Data Type** - Refer to individual memory maps for each type of device to determine the type of data. Eg. signed 16-bit int, unsigned 16-bit int or IEEE float. **GR Series** devices use IEEE float.

Start Addr. - This is the register address number to start the transaction from

No. Of Items - Enter the number of items from the start address that are included in the transaction. For example displayed here will be

10 SCV[1,1,1] - [1,1,10].

This means the transaction will take 10 items from the start address with a Serial Comms variable of Slave [1], Transaction [1], Register [1] - to Slave [1], Transaction [1], Register [10]

| | | | | |
|---------------|-------------------------------------|--------|--------|---------|
| Comms | Comms ... | MODBUS | Master | Slave 1 |
| Enabled | <input checked="" type="checkbox"/> | | | |
| Friendly Name | Slave Device | | | |
| ID | 1 | | | |
| Port | RS-485 | | | |
| Protocol | Modbus | | | |
| Transaction 1 | In 1 1 | | | |
| Back | Copy To | Finish | ? | |

Each Master device can have up to 32 slaves and each slave can perform up to 8 transactions.

| | | | | |
|--------------|-------------------------------------|--------|---------|------------|
| Comms S... | MODBUS | Master | Slave 1 | Transac... |
| Enabled | <input checked="" type="checkbox"/> | | | |
| Direction | In | | | |
| Command | Coil Status(1) | | | |
| Data Type | short | | | |
| Start Addr. | 1 | | | |
| No. Of Items | 10 SCV[1,1,10] | | | |
| Back | Copy To | Finish | ? | |

Slave

- **Enabled** - Toggle On to make this recorder a Slave Device
- **Port** - Select this for a list of available ports, either Ethernet or RS485 ports. For port configuration see ["Ports" on page 96](#).
- **Protocol** - Select this for a list of available protocols. Modbus or Modbus X*. Modbus and Modbus X can both use the Ethernet or RS485 ports. Protocols define the format in which the data is transferred from the recorder to a PC or transfer between other devices and peripherals. **FPLB** – Floating Point Little Endian Byte Swapped Format & **FP B** - Floating Point Big Endian Format are standard notations.
- **Slave ID** - This is a unique Modbus ID/Address used by the recorder to identify Modbus messages. Applications that talk to the recorder with Modbus will need to know this number to return messages to the device. If you are using the Communication Server on **TrendServer Pro** the same Slave ID number must be entered. (1-254)

RS485

- **Baud Rate** - Select this for a list of available Baud Rates. This is the speed, in bps (bits per second), at which data is transferred.
- **Byte Options** - Select this button for a list of available Byte Options. The Byte Options consist of 3 digits comprising of Parity (set to None N, Even E or Odd O), 8 Data Bits and Stop Bits, signifying the end of the character string, 1 or 2.
- **Line Turn Around** - This is for a 2-wire line type. Data has to be fully transmitted before the line can be turned-around and data can be received, or vice versa.
- **Reply Delay** - Enter a delay time, in milli seconds, before the recorder sends a reply. Recommended delay should be set to 12mS (min.) if using the Comms Server.

*Modbus X - Modbus X protocol differs from standard Modbus by the 4 floating point order which is reversed for application compatibility.

To check communications connections and trouble shooting network settings versus SCV parameters see “Comms Status” on page 182. This screen will help to identify which area to focus on if the recorder connections are not doing what you expected.

When the configuration is complete select the Finish button to Commit, Discard or Commit Later. Select the Back button to return to the previous menu.

Web

(Main Menu > Configure > Setup > Edit Setup > Comms > Comms Services > Web)

The Web browse function is enabled/disabled from this menu. Select this to enable and allow the recorder to be browsed on a web page. Internet access is required. The Web button is password protected if passwords are enabled. For web browsing information see “[Web Browser](#)” on page 276 and “[Internet Security Settings](#)” on page 277.

See “[Level Permissions](#)” on page 211 for information on how to Web Browse and have full remote control of your recorder from your PC. The Remote View function is a firmware option that is activated from the Factory menu > “[Credits](#)” on page 131.

Email

(Main Menu > Configure > Setup > Edit Setup > Comms > Comms Services > Email)

Set up this email menu in order to send emails for the following:

1. When an Alarm is triggered, see Email Alarms in the “[Alarms Menu](#)” on page 88
2. An Email can be sent as a part of an Event occurring, such as:
 - **Alarms** – In to, Out of or Acknowledged
 - **Totaliser** – Start, Stop or Reset
 - **Digital Inputs** – On, Off or State change
 - **TC Burnout** – on a specific Analogue Input channel
 - **Scheduled Events** – Once, Interval, Specific days, Month End.

For more information on setting up events that will send emails, see “[Event Effects](#)” on page 119.

| Field | Value |
|------------------|-------------------------------------|
| Server Name | EN84EV402.global.trains.com |
| Authentication | <input checked="" type="checkbox"/> |
| Username | loc 5 \1500 |
| Password | ***** |
| User Address | phil.d.gap@underground.com |
| Recipient Addr's | |

Server Name - Enter your server name that will handle the transfer of the emails. Ask your IT Admin for the server details. One method of finding this information is to go to Microsoft Outlook™, Tools, Email Accounts, select “View or change existing email accounts”. Select your email server from the box eg. Microsoft Exchange Server™ and click on the Change button. The server name you require is displayed in the Exchange Server Settings dialog. Enter this name exactly using the on-screen or USB keyboard.

Authentication - Indicates whether a username or password is read by the server. Check with your IT Admin.

For Network printers and drivers, if you intend to connect the recorder on a Microsoft network administered as a domain, you may have to authenticate the recorder as a user with sufficient permissions to use the resources that you want (network printer, network drive). Usually, several devices (computers or recorders) can be authenticated on the same network with the same name.

Username - Your network email address. (or this could be a generic name used to identify the recorder)

Password - Enter your password associated with your user name. If you have a system where the log in password expires and requires you to change it periodically, you will need to update the logon password in the recorders when you are forced to change your PC password.

User Address - Your network email address. Or this could be a generic name used to identify the recorder. No spaces!

Recipients Address - Enter up to 12 email addresses of the destination you want the email to be sent to.

Templates - These are user defined templates containing email text. If you require standard text to be sent out in an email then set them up here and give it a template name.

These templates can be used with the events function to send an email as an effect of an occurrence. [See “Event Effects” on page 119.](#)

Select a template from the list, add a Subject heading (up to 50 characters) and Message Body text as you would for a normal email. Type into the message body text box up to 80 characters per line and up to 100 lines of text can be entered including [“Embedded Process Values” on page 119.](#) This will include specific pen data to your email.

Contact your IT Administrator for advice on entering Server name requirements.

Figure 4.6 Templates for Email using Embedded Values

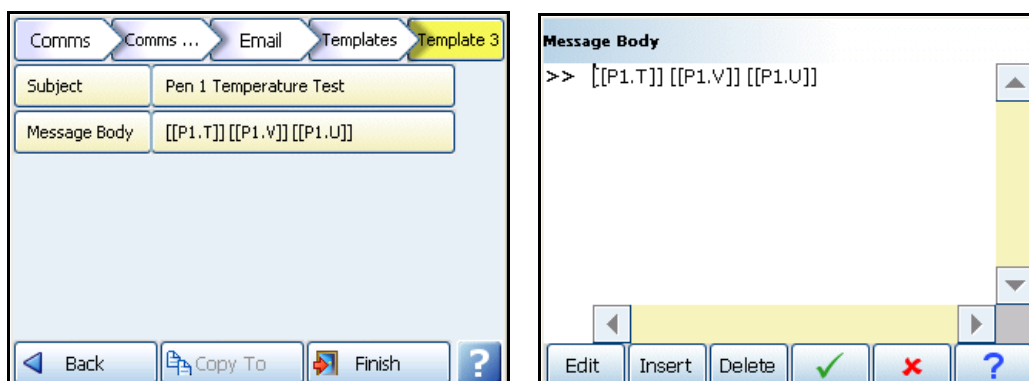

SNTP

(Main Menu > Configure > Setup > Edit Setup > Comms > Comms Services > SNTP)

Simple Network Time Protocols is a protocol for synchronising the clock on the recorder with a Network Server.

- **Server Enable** - Toggle On and Off. Activate this to make this recorder the server. Other recorders, set up as clients, can synchronise their time to this server recorder.
- **Client Enable** - Toggle On and Off. Activate this to set this recorder to synchronise time with the server. See [Figure 4.7 on page 109](#).
- **Server Name** - (up to 32 characters). Only available when Client Enable is active. This is the name of the Network Server that can be used for time synchronisation. Enter the server name to be used for time synchronisation (this could be a Time Server on the internet or on your network). If a recorder is acting as the Server, the Client recorders must have the recorder's network ID. eg. **xs-nnnnnn**, this is the 6-digit Serial number. See ["System" on page 195](#) for the recorder's serial number.
- **Period** - Only available when Client Enable is active. Select and enter the time period in seconds required between checking and updating the time using the on-screen keyboard. **X Series** recorders have a period limit of 60 to 3600 seconds, **GR-Series** recorders have a period limit of 600 to 3600 seconds.
- **Threshold** - Only available when Client Enable is active. This is a specified amount of time (in seconds) that the recorder clock must be within to ensure synchronisation with the network server. Eg. if set to 3600 the recorder time must be within 1 hour of the network server to ensure time sync will take place.

Figure 4.7 Client/Server network

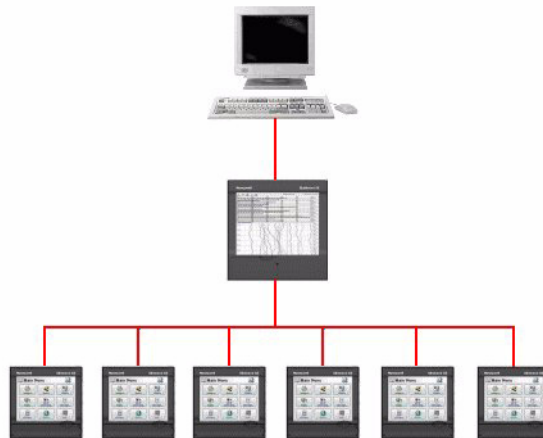

When using time synchronisation via SNTP, always make sure that the recorders and the PC if any are configured to the same time zone. See [“Localisation” on page 136](#)

Client/Server Network

[Figure 4.7 on page 109](#) shows a Network Server at the top, a recorder acting as both a server and a client in the middle and a string of client recorders at the bottom. A recorder can be set up to be a server and a client. Setting it as both means this recorder will synchronise time with the network server. But will also allow other recorders to time sync with it. This saves many recorders trying to time sync with the network server.

When the configuration is complete select the Finish button to Commit, Discard or Commit Later. Select the Back button to return to the previous menu.

FTP (File Transfer Protocol)

(Main Menu > Configure > Setup > Edit Setup > Comms > Comms Services > FTP)

This is a method of transferring data and setups to and from **TrendManager Software Suite** and the recorder.

- **Enabled** - Tick to enable FTP transfer
- **Allow Upload** - Tick to allow FTP transfer **from TrendManager Software Suite to the recorder.**
- **Allow Download** - Tick to allow FTP transfer **from the recorder to TrendManager Software Suite.**
- **Log Messages** - Tick to add a message to the messages list when an FTP transfer is performed
- **Mark Chart** - Can only be active when Log Messages is enabled. Tick to mark the chart when an FTP transfer is performed.

Refer to [“Section 8: Communication” on page 245](#) in this manual and the **TrendManager Software Suite** manual for setting up FTP transfer.

Secure FTP

The **GR Series** recorders support a Credit enabled function for doing secure FTP data transfers since the normal FTP protocol is an unsecure protocol. . See [“Secure Communications” on page 100](#)

Peers

The Peer services communication function sets up the recorder so it can be recognised on a network containing other **GR Series** recorders. This means that multiple recorders will be able to discover other recorders on the same local network in order to share data between them. For example basic unit information such as firmware version, recorder name and network identity. This will be used mainly with the **Trend Server** software to allow discovery of recorders in order to transfer data via FTP or Modbus.

- **Enabled** - tick to enable
- **Set Number** – Default to set 1, this should not have to be changed unless a lot of recorders are being used on the same network.
- **Start Port** - Default port number 8955
- **End Port**- Default port number 8970

The port numbers have been specially selected for this type of network communications. It is recommended that the ports are **not** changed unless specifically requested by your IT network administrator. If this is changed on the recorder it must also be changed on all other recorders, **TrendServer** and Comms Server.

If you experience and security issues using peers, see [“Internet Security Settings” on page 277](#).

Events/Counters

(Main Menu > Configure > Setup > Edit Setup > Events/Counters)

Events - See "Events Menu" on page 111.

Counters - See "Counters Menu" on page 126.

Preset Markers - See "Preset Markers" on page 127.

Time Sync - See "Time Sync" on page 127



Events Menu

(Main Menu > Configure > Setup > Edit Setup > Events/Counters > Events)

Events is a firmware option that can be activated using the credit system.

All Event occurrences can be viewed in "Events Status" on page 203.

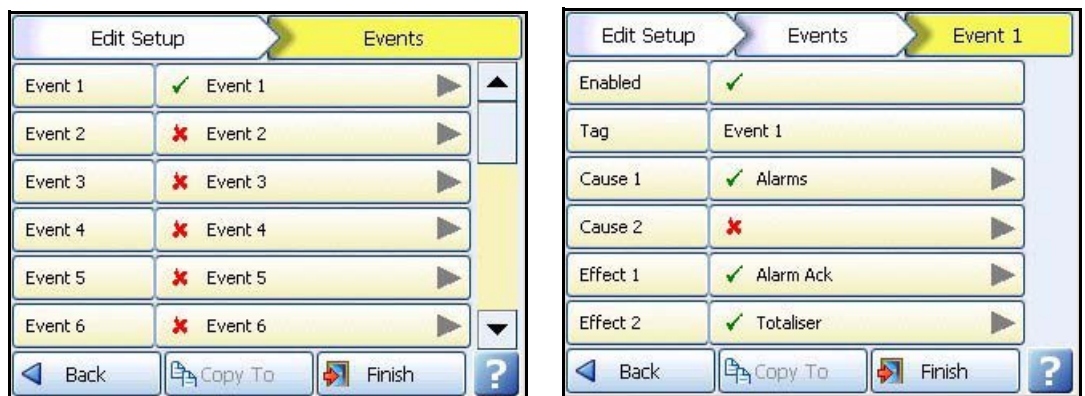

Events are certain conditions or operations which can be set up and logged according to the time and date of the occurrence. Subsequently events can be reviewed in a list or represented on a graph.

An event is made up from a Cause and an Effect. For example set up a cause, such as Pen 1 going into an alarm state and the effect of this could be to start a totaliser or acknowledge the alarm.

Select the first available event eg. Event 1. In the Event 1 menu tick to enable and change the Event tag if required. Each Event has four Causes and four Effects available, these can be used in different combinations:

NOTICE

Remember that any of the Causes will trigger All the Effects.
Cause 1 and Effect 1 are not linked.

- An event can have up to 4 causes that triggers just one effect eg. A pen going into alarm, a Totaliser starts, Max/Mins reset and a Batch starts. This could have the effect of starting Logging.
- An event can have one cause that has up to 4 effects, eg. A pen could go into alarm and the effects could be that the alarm is acknowledged and a Totaliser is started, there is a Mark placed on the chart and an Alarm is sounded. See [“Event 1 example:” on page 114.](#)
- An event can have up to 4 causes that have up to 4 effects, eg. A pen goes into alarm and a Totalisers is started, A scheduled export starts and Max/Min values are reset. The effects could be the alarm is acknowledged and a mark on chart is displayed to show the start of the totaliser, an Email is sent to notify a scheduled export has been made and a sound effect is played to identify the Max/Min values have been reset.

In summary Cause 1, 2, 3 **or** Cause 4 will trigger Effect 1, 2, 3 **and** Effect 4.

When selecting Totalisers and Alarms etc. ensure they are enabled and configured in the Pens menu.

Table 4.4 : Events - Cause and Effect

| Cause | | Effect |
|-------------------|----------------------|-------------------------|
| Alarm | Into Alarm | Mark on Chart |
| | Out of Alarm | |
| | Acknowledge Alarm | |
| Totalisers | Start | Logging |
| | Stop | Totaliser |
| | Reset | Digital Outputs |
| | Rollover | Alarm Acknowledge |
| Digital Inputs | On | Email |
| | Off | Screen Change |
| | State Change | Print Screen |
| T/C Burn Out | Analogue Input # | Counters |
| Scheduled | Once | Max Mins (Reset) |
| | Interval | Chart Control |
| | Specific Days | Clear Messages |
| | Month End | Delayed Event |
| User Counters | User Counter # | Script Timers |
| Max Mins (Reset) | Reset Max/Min values | Play Sound |
| System | Power On | Display Alert |
| | Setup Change | Batch |
| | Internal Mem. Low | Reports |
| | Export Mem Low | Update Tabular Readings |
| | FTP Mem Low | Enter Replay Screen |
| User Action | Mark Chart | Exit Replay Screen |
| | Hot Button | Change Chart Speed |
| Batch | Start Batch | |
| | Stop Batch | |
| | Pause Batch | |
| TUS | Start | |
| | Stop | |
| AMS2750 Timer | TC Timers | |
| | Process Timers | |
| TC Health Monitor | Analogue Inputs | |

Figure 4.8 Event 1 example:

Event 1 example: Adding Cause 1

| | | | |
|--|------------|---------|---------|
| Edit Setup | Events | Event 1 | Cause 1 |
| Enabled | ✓ | | |
| Type | Alarms | | |
| Sub Type | Into Alarm | | |
| Pen | 2 | | |
| Alarms | None | | |
| <input type="button" value="Back"/> <input type="button" value="Copy To"/> <input type="button" value="Finish"/> <input type="button" value="Help"/> | | | |

| |
|----------------|
| Alarms |
| Totalisers |
| Digital Inputs |
| TC Burn Out |
| Cancel |

| |
|--------------|
| Into Alarm |
| Out of Alarm |
| Ack. Alarm |
| Cancel |

Event 1 example: Adding Effect 1

| | | | |
|--|-----------|---------|----------|
| Edit Setup | Events | Event 1 | Effect 1 |
| Enabled | ✓ | | |
| Type | Alarm Ack | | |
| Pen | 2 | | |
| Alarms | 1 | | |
| <input type="button" value="Back"/> <input type="button" value="Copy To"/> <input type="button" value="Finish"/> <input type="button" value="Help"/> | | | |

| |
|-----------------|
| Mark Chart |
| Logging |
| Totaliser |
| Digital Outputs |
| Alarm Ack |

Select which Pen number and which alarm on that pen, will have the alarm acknowledged.

Event 1 example: Adding Effect 2

| | | | |
|--|-----------|---------|----------|
| Edit Setup | Events | Event 1 | Effect 2 |
| Enabled | ✓ | | |
| Type | Totaliser | | |
| Sub Type | Start | | |
| Pens | None | | |
| <input type="button" value="Back"/> <input type="button" value="Copy To"/> <input type="button" value="Finish"/> <input type="button" value="Help"/> | | | |

| |
|-----------------|
| Mark Chart |
| Logging |
| Totaliser |
| Digital Outputs |
| Alarm Ack |

| |
|----------|
| Start |
| Stop |
| Reset |
| Rollover |
| Cancel |

Event Causes

- **Alarms** - Set to cause an event when a pen goes Into Alarm, Out of Alarm or an Alarm is Acknowledged. Set the pen number and the Alarm that will trigger this event.
- **Totalisers** - Set to cause an event when a totaliser Starts, Stops, is Reset or a Rollover is required. Select which pen has been set up as a totalise pen to trigger this event. The upper limit for the totaliser count is can be selected to prevent an inaccuracy in the calculation above this upper limit. Totalizer rollover is also seletcatble. The Totaliser Rollover occurs automatically once the count reaches the accuracy limit and totaliser starts counting from zero. If the user fails to configure the event totaliser it will auto reset. The Rollover cause gets triggered each time the totaliser rollover occurs, above the accuracy limit.
- **Digital Inputs** - Set to cause an event when a Digital Input is turned On, Off or has a State change. Select the Digital to trigger this event.
- **TC Burn Out** - Select which analogue input has a thermocouple on that will trigger this event when it goes into a burnout state.
- **Scheduled** - See [“Scheduled Events” on page 116.](#)
- **User Counters** - See [“User Counters” on page 117.](#)
- **Max Mins (Reset)** - A manual reset of the Max/Min values by the user can be used as a cause to then trigger an effect. Max Min values can be reset in the process menu, see [“Max/Min” on page 190.](#)
- **System** - An occurrence in the system can be used as a cause to trigger an event effect. System occurrences include Power On, Setup Change, Internal Memory Low, Export Memory Low and FTP Memory Low. The system monitors the memory storage levels and triggers the alert when the low level set is reached. To set the memory low level go to the Edit Recording menu, go to [“Storage Alarm” on page 150.](#)
- **User Action** - Select a User Action for placing a Mark on the Chart as a cause to trigger and event. Or add a Hot Button which can be displayed on an active Trend screen.



- *The Hot Button function, when active as a cause. The user can click the Hot Button on the active screen and the corresponding event (that the user needs to set) will be triggered. The hot button will display on active trend screens in top right of screen if enabled.*

- **Batch** - Use a batch control as a cause to trigger an event effect. An event cause can be set up so that when you Start, Stop or Pause a batch it will cause an effect to occur. Batches work using groups of pens so when setting up an event with a batch control as a cause you must assign a group of pens. See [“Groups” on page 142.](#)
- **TUS** (Temperature uniformity Survey) - This will only be enabled if the AMS2750 TUS or AMS2750 Process option has been enabled in the recorder credits menu. Select either Start or Stop TUS. When a TUS is started or stopped this can be used to trigger and effect. See [“Appendix L: GR Series AMS2750 capabilities” on page 377](#)
- **AMS2750 Timer** - This will only be enabled if the AMS2750 TUS or the AMS2750 Process option has been enabled in the recorder credits menu. Select TC Timers or Process Timers as a cause and set the Alert Type to Warning or Expired. See [“Appendix L: GR Series AMS2750 capabilities” on page 377](#)
- **TC Health Monitor** - TC Health Monitoring allows monitoring the health of a thermocouple using Event/Cause Effect system. Following errors can be generated on each channel of TC:-

- Active burnout almost failed on AI channel
- Active burnout S/C detected on AI channel
- Upscale burnout on AI channel
- Downscale burnout on AI channel
- Out of burnout on AI channel

Configure the event/effects for the above mentioned errors accordingly. The diagnostic messages are logged in the recorder.

Scheduled Events

A scheduled event can be set up as a cause so that when a scheduled event occurs it triggers an effect. With scheduled events you can specify the time and date for something to happen. Eg. A schedule can be setup every weekday at 12.00pm to send an Email.

| | | | |
|-----------------|-------------------------------------|---------|---------|
| Edit Setup | Events | Event 1 | Cause 1 |
| Enabled | <input checked="" type="checkbox"/> | | |
| Type | Scheduled | | |
| Sub Type | Specific Days | | |
| Day of the W... | Mon, Tues, Weds, Thurs, Fri | | |
| Time Of Day | 12:00:00 PM | | |
| Count | 10 | | |
| | | | |

- **Enabled** - Tick to enable
- **Type** - Scheduled
- **Sub Type** - Set Once, Interval, Specific Days or Month End
 - Once** – This is a once only occurrence
 - Interval** - A scheduled can be setup at timed intervals eg. every 12 hours.
 - Specific days** - Select the day(s), time and how often (count) the schedule will occur
Eg. Friday at 12.00 with a count of 10 will carry on for 10 weeks or Monday through to Friday at 12.00 with a count of 10 will carry on for two weeks.
 - Month End** - If Month End is selected with a count of 10 it will carry on for 10 months. The recorder refers to a built in calendar and clock and will schedule the event to occur at midnight on the last day of each month.
- **Date/Time** - Only available when Once is selected as a Sub Type. Select the time and date for a one off occurrence.
- **Period** - Only available when Interval is selected as a Sub Type. Set the time interval for how often this event should occur, eg. every hour would be 1h:00m:00s
- **Alignment** - Only available when Interval is selected as a Sub Type. Select and enter a value from the list to align the scheduled event at specific intervals.
For certain applications it maybe desirable for a relatively fast schedule interval event, for example every 10 minutes, to be aligned with a particular time. For example on the hour.
When the alignment function is not used, the schedule interval starts immediately on

committing the configuration. When the alignment function is used, the schedule interval starts when the first interval event coincides with a subsequent interval that lines up with the desired alignment ie. Top of the hour.

Figure 4.9 Interval alignment

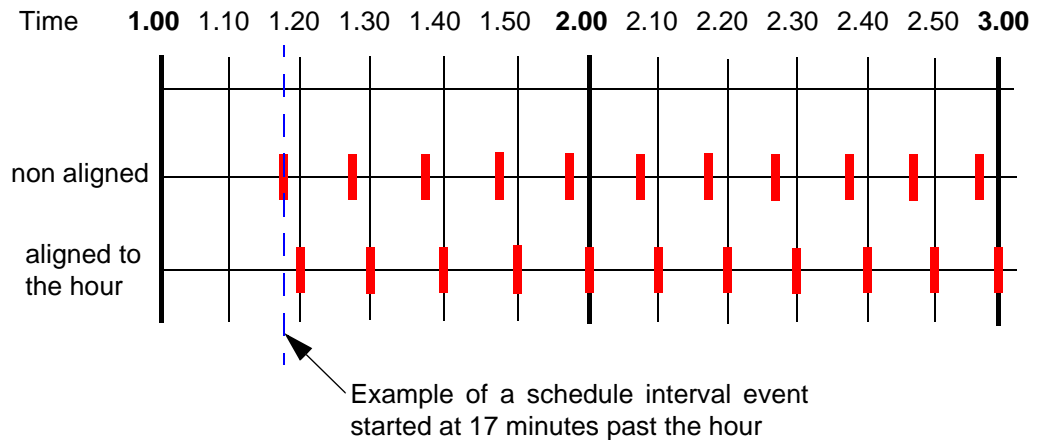

Figure 4.9 shows if a 10 minutes schedule is required to align with a whole hour, and the configuration is committed at 17 minutes past, the recorder will wait until 20 past before starting the schedule interval. As starting at 20 past with 10 minute increments will ensure alignment with a whole hour.

- **Count** - Only available when Interval, Specific Days or Month End are selected as a Sub Type. This is how often you want this to occur. The recorder will carry on with this schedule for the amount entered in the count. Eg. If 24 is entered into the count the scheduled event will occur at the specified time for 24 hours. A count of zero will carry on indefinitely.
- **Days of the Week** - Only available when Specific Days is selected as a Sub Type. Select the days of the week when this scheduled event is to occur.
- **Time of Day** - Only available when Specific Days is selected as a Sub Type. Select the Time Of Day when this scheduled event is to occur.

User Counters

User Counters are quite simply counters that are set up by the user. User Counters can be used as a Cause to trigger an Event Effect. The User Counter information must be setup in the before it can be used as a part of the event system. [See “Counters Menu” on page 126.](#)

For a User Counter to be used as a Cause, a User Counter must already be set up and be counting something. eg. a User Counter as an Effect of another Event.

An example of this could be:

First setup your counter in the Counters menu. Enable it, Name it, enter the number the count will Start At and enter at what number it will Rollover and start again. [See “Counters Menu” on page 126.](#)

Event 1 has been set up with Cause 1 as a Scheduled interval every 30 seconds. The Effect is that User Counter 1 is set to increment by 1. When the scheduled interval occurs, every 30 seconds, Counter 1 will increment by 1.

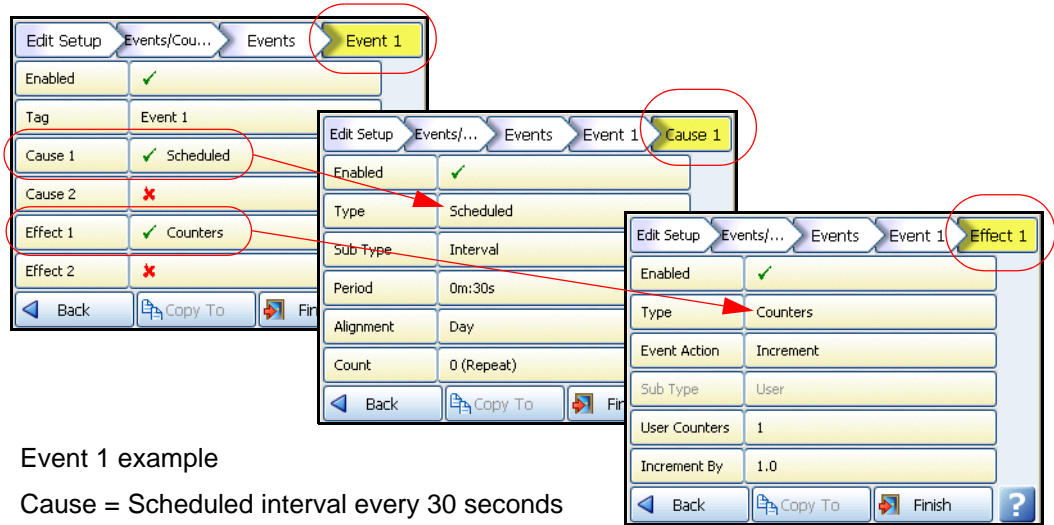

Event 1 example

Cause = Scheduled interval every 30 seconds
 Effect = User Counter increments by 1

A second Event can then be set up using the User Counter Effect in Event 1 as the Cause for Event 2. In this example the Cause will be triggered by User Counter 1 (in Event 1) reaching an count of 50. The Effect of this will be a Mark on Chart.

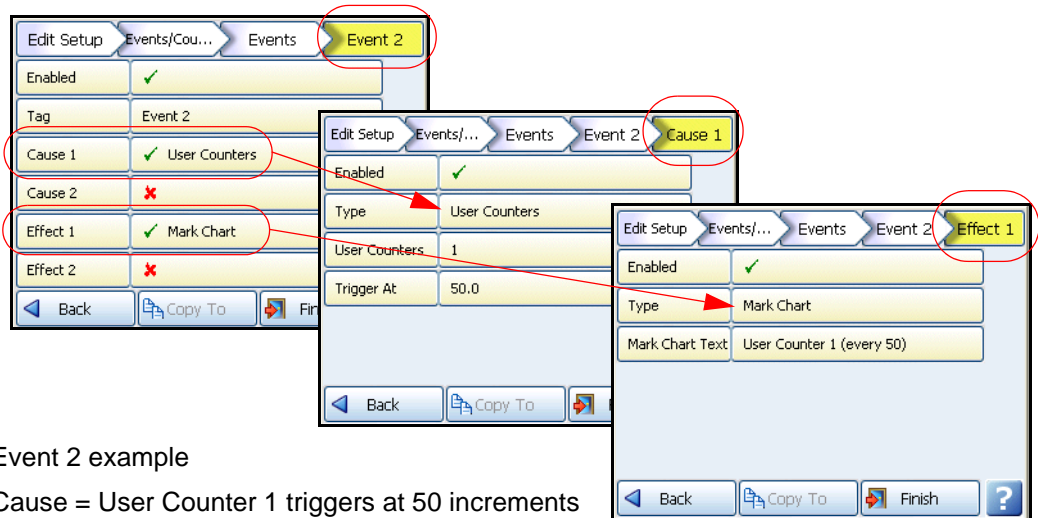

Event 2 example

Cause = User Counter 1 triggers at 50 increments
 Effect = A Mark is placed on the Chart

In summary: every 30 seconds a scheduled interval will cause a counter to increment by 1. When the increments reach 50 a mark will be placed on the Chart.

Event Effects

- **Enabled** - Tick to enable
- **Type** – Choose from Mark on Chart, Logging, Totaliser, Digital Outputs, Alarm Ack, Email, Screen Change, Print Screen, Counters, Max Mins (Reset), Chart Control, Clear All Messages, Delayed Event, Script Timers, Play Sounds, Display Alert, Batch, Reports and Update Tabular Readings.

Depending on the Type of effect selected the menus will change as follows:

- **Mark on Chart** - If a pen goes into an alarm state the effect would be a mark will be placed on a chart and will display, for example: "Pen 2 Alm 1: Into Alarm (37)". Select Marker Type as Preset to display a list of all available markers that have been previously added to the recorder. To add Preset Markers go to ["Preset Markers" on page 127](#). Select the Marker Type as User Defined to add pen information using Embedded Process Variable.

Embedded Process Values

Adding Embedded Process Values in a Mark on Chart means you can display information such as:

Table 4.5 : Embedded Process Variables

| Variable | Description |
|-----------------|---|
| V | Value |
| T | Tag |
| Z | Zero range |
| S | Span range |
| U | Unit Text |
| time.v | Time in HH:MM:SS format |
| date.v | Date in DD:MM:YY format |
| td.v | Time and Date in HH:MM:SS and DD:MM:YY format |
| name.v | recorder name |
| id.v | recorder ID |
| serial.v | serial number |

Table 4.6 : Embedded examples

| Text Entry | Function | Examples |
|--------------|---|-------------------------------|
| [[P1.V]] | will embed the current Value of P1 | <<16.233>> |
| [[P1.T]] | will embed the current Tag of P1 | <<Pen 1>> |
| [[P1.Z]] | will embed the Zero point of P1 | <<0>> |
| [[P1.S]] | will embed the span point of P1 | <<100>> |
| [[P1.U]] | will embed the Unit text of P1 | <<deg C>> |
| [[time.v]] | will embed the current time | <<11:51:23>> |
| [[date.v]] | will embed the current date | <<10:11:06>> |
| [[td.v]] | will embed the current time and date | <<11:51:23 10:11:0>> |
| [[name.v]] | will embed the current recorder name | <<Furnace1>> |
| [[id.v]] | will embed the current recorder ID | <<21>> |
| [[serial.v]] | will embed the recorder serial number | <<200034>> |
| [[BATMD1.v]] | will embed the batch mode. 1 = Running, 2 = Stopped, 3 = Paused | <<Batch-1- 0001234 Stopped >> |
| [[BATMD1.t]] | will embed the batch name | <<Batch-1-0001234 Group 1>> |

Batch mode is for each group BATMD1 to BATMD6. Used in embedded variables as [[BATMD1.v]], will also allow the current batch name to be embedded using [[BATMD.t]].

Maths variables as embedded variables

Other information can be accessed by exchanging the Pn with the following variables, see [Figure 4.7](#).

Table 4.7 : more embedded variables

| Syntax | Syntax | Syntax |
|--------|--------|----------|
| An | GLBVn | HPULn |
| BATMDn | HPC1 | LPULn |
| BLKVn | INTHRS | RAn |
| CFFREE | IOC1 | RTCOMPn |
| CJcN | LPC1 | RTCALn |
| CJcNC | Pn | Tn |
| CVn | PnAnL | UC1 |
| Dn | PnMINU | USB1FREE |
| DIOn | PnMAXU | USB2FREE |
| EC1 | PSTVn | UV1 |
| FTPHRS | PRC | |

In [Figure 4.12](#) is an example that shows pen information can be used as an embedded variable.

An example for pen information, in Mark on Chart enter: `[[name.v]] [[P1.T]] [[P1.V]] [[P1.U]]`.

Figure 4.10 Embedded variables for pen information

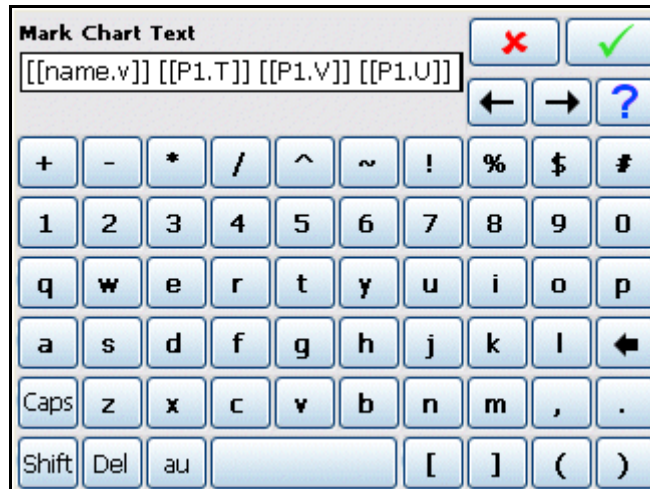

This will display the marker as: Furnace1 Temperature is 14.81 Deg C.

If Pen 1 name is Furnace1, Tag is “Temperature”, the current value is 14.81, and the Unit text is “Deg C”.

Embedded process variables can be used for Pen reports. [See “Pen Report Syntax” on page 156](#)

Embedded variable are not case sensitive and spaces are allowed.

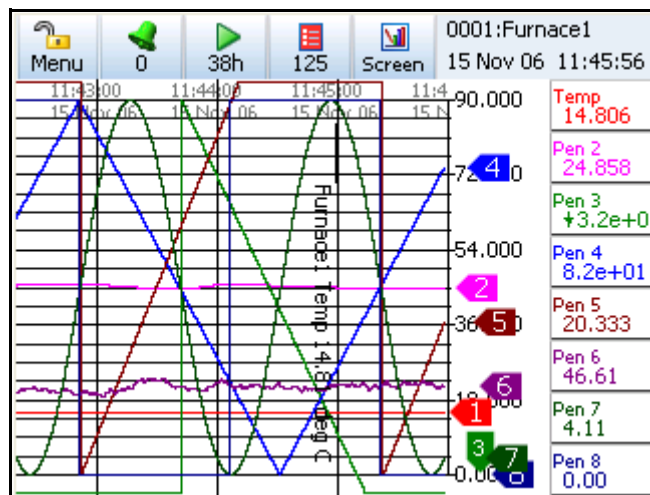

Event Effects (continued)

- **Logging** - Is an event effect that can Start or Stop logging, enter which one in Sub Type. From Selection Type choose either Multiple pens, Pen group or All Pens and select the relevant pen(s) below.
- **Totaliser** - Is an event effect that can Start, Stop, Reset or Reset and Start a Totaliser in Sub Type. From Selection Type choose either Multiple pens, Pen group or All Pens and select the relevant pen(s) below.
- **Digital Outputs** - Is an event effect that can switch a Digital Output On or Off. Enter which one in Sub Type and select the relevant relay output(s)
- **Alarm Acknowledge** - this is an effect of an event that can acknowledge a latched alarm on a Single Pen, Pen Group or All pens. Select the pen and the number of alarm to be acknowledged.
- **Email** – Is an event effect that will send an Email when triggered by a Cause. Eg. Cause = Totaliser Starts, Effect = Email is sent.
 - **Sub Type** - Auto, Single Line User or Multiline User. Auto will enter what the Event was eg. Scheduled or Alarm triggered. Single Line User can have up to 69 characters of text or use [“Embedded Process Values” on page 119](#). Multiline User can have up to 80 characters per line with up to 1000 characters including spaces, carriage returns and line feed in total. They can also include embedded process variable. [“Maths variables as embedded variables” on page 120](#) can be used in an email.
 - **Recipients** - Enter email recipients from the list. If no email recipients are present in the list, they must be entered first in the Email menu, see [“Email” on page 106](#).
 - **Embed Screenshot** - This feature allows a screen shot of the current screen to be attached to an out-going email, the attachment is in bitmap (.bmp) format.
 - **Email Text** - Only available when Single Line User is selected as a Sub Type. Enter text here to add a Mark on Chart when the Email is sent.
 - **Email Template** - Only available when Multiline User is selected. These are sets of text scripts that can be pre-written and assigned to an Email. Select a template from the list. To set up templates for multiline text, see [“Email” on page 106](#).

Figure 4.11 Event Effect using a Template with Embedded values

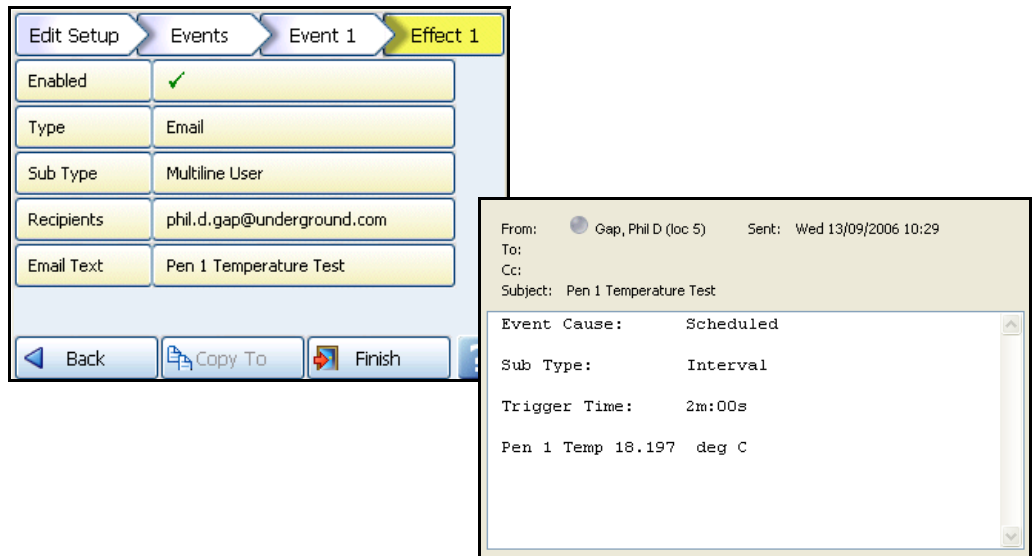

- **Screen Change - (or Backlight On/Off)** Select Screen Change as an effect to change the screen when triggered by an active alarm or system alert message. Eg. Pen 1 goes into Alarm and the screen changes from a chart to a DPM screen where Alarm markers are visible.
 - *Backlight: select On or Off. When the Event is triggered the effect is to turn the backlight to what state has been selected, On or Off. If an active alarm is triggered it will override this state as it has a higher priority.*
 - *Screen Name - select which screen will be the result of the Screen Change effect, to now including non-process screens*
- **Print Screen** – As an Effect, this will print the current screen when triggered by a Cause. Eg. Cause = Digital turns on, Effect = Print Screen. To set up network printer information see [“Network Admin” on page 98](#).
- **Counters** - Counters can be used as an Effect of an Event to count an occurrence or to reset different types of counters. A User Counter must be set up first before it can be used as a part of an Event. See [“Counters Menu” on page 126](#).
 - **Enabled** - Tick to enable Event
 - **Type** - Counters
 - **Event Action** - Increment will add by whatever value is entered in “Increment By”. Reset will restart the counter to whatever number is entered in Reset To.
 - **Sub Type** - (only available when Reset is selected as the Event Action). Select to reset User, Pulse, Events, Digital Inputs, Relay Outputs or Alarm counters. Selecting any of these Sub-Types will activate the corresponding menu item(s) so you can then specify the number of the Sub-Type to be reset. To view counters using a maths equation, see [“Maths Variable Table” on page 322](#).
 - **User Counters** - (only available when Sub-Type is set to User). Select the User Counter number to be used from the available list. Counters will only be available if they have first been set up in the User Counters Menu.

- **Increment By** - (only available when Increment is selected as the Event Action). Enter the number at which you want the counter to increment by when the event cause is triggered.
- **Reset To** - (only available when Reset is selected as the Event Action and Sub-Type is set to User). Enter the number at which you want the counter to reset to when the event cause is triggered.
- **Max Mins Reset** - Use this as an effect of an event to reset all Max Min values
- **Chart Control** - The chart activity can be controlled as an effect of an event. The chart control options are; Pause, Stop, Resume, Clear and Prefill.

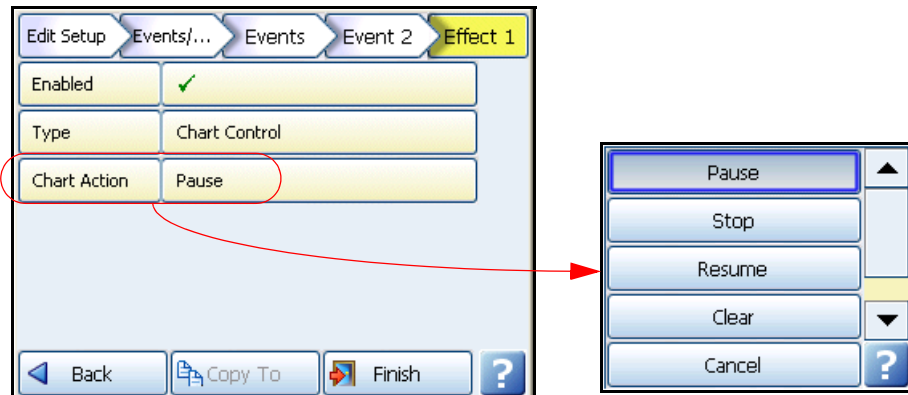

- **Pause** - this will pause the chart until it is resumed. Resuming a paused chart will display continuous chart data from when it had been paused. The chart can be stopped if in a paused state. If the Event is disabled the chart will need to be restarted using Resume as an event effect or by resetting the recorder.
- **Stop** - this will stop the chart and no chart data will be displayed for the length of time the chart is stopped. If a stopped chart is resumed there will be a gap in the displayed chart data. If the Event is disabled the chart will need to be restarted using Resume as an event effect or by resetting the recorder.
- **Resume** - this can be used after the chart has been stopped or paused. The chart data will continue from where it has been paused with no gaps displayed. But if the chart has been stopped the displayed data will display a gap in data until it is resumed
- **Clear** - this will clear all the data from the chart being displayed. Data will not be cleared if the chart has been stopped. This will not clear recorder data from the memory, only the chart.
- **Prefill** - this will clear the chart and then fill it with the current reading. A stopped chart cannot be prefilled.
- **Clear All Messages** - this will clear all the messages in the message list. [See “Messages Menu” on page 187.](#)
- **Delayed Event** - This will allow one event to trigger one or more other events after a specified period of time. The time period can be set in seconds from 1 to 3600 (1 hour). Select Delayed Event and select the event(s) this will apply to. Enter the time delay.
- **Script Timers** - Script timers provide 20 independent timers to be used as desired, previously control and access of script timers was limited to maths functions for use in script but this has now been extended allowing the timers to be controlled using the

event system, allowing them to be stopped, started and reset. Script timers can also be viewed in [“Script Timers” on page 192](#). Access to timers via the Maths scripting feature is still available, see [Table 14.4 on page 327](#).

- **Play Sound** - Sound effects can be used to alert the user that an event effect has occurred. Set the Sub Type to Start to reveal two more menu options, Sound name and Play Mode. The user can pick from a list of 20 different sounds these can be configured to play a single time or repeat continuously. **Please be aware that continuous mode will repeat continuously until a corresponding “stop” event is triggered for that sound.** Also like ring tones the sounds themselves can be replaced on the recorder with custom sounds. To update the sounds see [“Update Sounds” on page 173](#).
- **Display Alert** - Display alert as an event effect – this feature is available from within the event system where the Alert Display can be used as an event effect to display a preset or user defined marker.
Select Message Type as Preset to display a list of all available markers that have been previously added to the recorder. To add Preset Markers go to [“Preset Markers” on page 127](#). Select the Message Type as User Defined to enter your own text.
For more information on the Alert system and how to customise it see [“Error Alert” on page 129](#).
- **Batch** - Batch controls can be used as the effect of an event occurring. An event cause must be set up so that the effect of the event is to Start, Stop or Pause a batch. Batches work using groups of pens so when setting up an event with a batch control as a cause you must assign a group of pens. Up to 32 Pens in any single batch group. See [“Groups” on page 142](#).
- **Reports** - A report can be created as an effect of an event. Reports can be generated on a periodical basis using event system to show daily/weeks/monthly totals, max mins, averages etc. the reports can be printed, e-mailed as attachments or exported to external media. A batch report for a Temperature Uniformity Survey can be produced. Before a report can be run the report details must be entered in [“Reports Menu” on page 153](#).
- **Update Tabular Readings** - Triggering this event causes the tabular display to update and show the latest set of readings.
- **Enter Replay Screen** - An event can be set so that the effect is to change the screen to enter the Replay Screen.
- **Exit Replay Screen** - An event can be set so that the effect is to change the screen so that the recorder will Exit the Replay Screen.
- **Change Chart Speed** - An event can be set so that the effect is to change the Change Chart Speed. The speed of the chart can be set in the Sub Type section for Fast (6000mm/h), Medium (120mm/h) or Slow(10mm/h). When that event gets triggered, selected chart speed will be set to the current active screen.

Event triggering from scripts

- **Trigger an Event:** This feature allows any enabled event with an enabled effect (does not have to have any causes enabled) to be triggered from within the scripting system using the following function, TRIGE[x] where x is the event 1 to 20.
- **Clear Event:** Once an event is triggered using scripting the event is locked and cannot be triggered again from scripts until the lock is cleared using the clear event function CLRE[x] where x is the event number 1 to 20. This prevent successive executions re-triggering the same event. As a further measure to avoid the system being overloaded

by events from within the script system, each time an event is triggered from within a script it will apply a 1 second automatic lock preventing the same event from being triggered more than once a second, irrespective of the CLRE[x] being called for that event.

- Set/clear a digital output:: This feature allows a digital output to be set or cleared from a script, using the function SETD[x,y] where x is the digital output 1 to 49 (where 49 is the power relay) and y is the value 1 to set or 0 to clear. The function will return the value set if successful, if not successful it will return -1.0, this would be caused by trying to set and digital input rather than output.

See, [Table 14.2, "Maths Function Table," on page 324.](#)

Counters Menu

(Main Menu > Configure > Setup > Edit Setup > Events/Counters > Counters)

Up to 16 User Counters are available and can be used as a part of the Events system. User Counters can be set up as a Cause or an Effect of an Event.

Setup a User Counter

Select the next available Counter number.

| | |
|-------------|-----------|
| Enabled | ✓ |
| Name | Counter 1 |
| Start At | 1.0 |
| Rollover At | 100.0 |

Back Copy To Finish ?

- **Enabled** - In the Counter # menu tick to Enable.
- **Name** - Name the counter for ease of identification.
- **Start At** - Enter the number at which you want the counter to Start At
- **Rollover** - Enter the number at which you want the counter to Rollover At. The default maximum Rollover value is $3.3e+38$. When the count reaches the rollover number entered it will restart the count from your Start At number

Once a User Counter is setup it has to be assigned something to count eg. as a part as an Event. [See "User Counters" on page 117.](#)

Preset Markers

(Main Menu > Configure > Setup > Edit Setup > Events/Counters > Preset Markers)

Set up marker text that can be used to mark the chart as a part of an Event Effect or manual added from the process screen as a Mark on Chart.

The mark on chart functionality has been extended to include the use of 20 separate preset markers. With some markers configured when using mark on chart the user has the option of starting with blank text, the previously entered text or one of the preset markers. Preset markers are also used in the Mark on chart effect and the Alert system effect. See [“Error Alert” on page 129](#).

To add text to a marker, select the next available marker and enter the text via the on screen keypad. Hit the tick mark to accept the text and then go to Finish to confirm.

Time Sync

(Main Menu > Configure > Setup > Edit Setup > Events/Counters > Time Sync)

This provides Time Synchronisation on recorders on a Digital Input.

- **Enabled** - Select the tick to enable Time Sync.
- **Trigger** - When recorder receives the Digital Input and there is a state change, i.e. On or OFF, then the recorder time will be synchronized to the nearest hour.
- **Digital Input** - Choice the input pulse through one of the channels supported (1 to 4). Time sync will only happen on the configured channel when digital input is received on that configured channel.

Once the time synchronization is complete, message will be send in the system messages to show time changed on digital input. This will notify the user that system time has been synchronized to the nearest hour due to digital input. Time synchronisation is, at best, precise to +/- 1 second.

Time changes (eg. daylight saving)

During resetting the time or updating the time change in the recorder, no data gets collected during this interval and a system message will show evidence of time change. In the case of daylight saving, if recorder clock is behind the hour, there will be a gap in data collection. For example, when recorder receives the digital input and there is a state change, the recorders system clock is showing 11.58 AM, i.e. behind the hour then there will be a gap of 2 minutes in data collection as the time will be synchronized to the nearest hour.

If recorder clock is ahead of the hour then there will be duplicate data entry. For example, when recorder receives the digital input and there is a state change, the recorders system clock is showing 12.02 PM, i.e. ahead of the hour then there will be a duplicate data entry of 2 minutes as the time will be synchronized to the nearest hour. The data collected before synchronization will be preserved.

General Menu

(Main Menu > Configure > Setup > Edit Setup > General)

From this screen select the buttons required for General recorder configuration.



- **Identity** - Unique recorder information; Name, Description and ID. [See "Identity" on page 128](#)
- **Error Alert** - Setup and customise the Alert box information. [See "Error Alert" on page 129.](#)
- **Factory** - This menu contains Credits (for activating recorder options), Firmware Upgrade, Calibration, Demo Traces, Reset Setup and Localisation. [See "Factory" on page 131](#)
- **Batch** - The Batch menu is for entering the Batch requirements for starting a new batch, including using a Barcode reader. ["Batch Menu" on page 138.](#)
- **Printer** - The Printer menu allows configuration for setting up a printer. [See "Printer Menu" on page 141.](#)
- **Groups** - Groups of Pens can be specified and named with a Group name or number. [See "Groups" on page 142.](#)

When the configuration is complete select the Finish button to Commit, Discard or Commit Later. Select the Back button to return to the previous menu.

Identity

(Main Menu > Configure > Setup > Edit Setup > General > Ident)

Unique recorder information.

- **Name** - Enter the recorder's name. Maximum characters 32
- **Description** - Enter a description for the recorder using the on-screen keyboard. Maximum characters 64
- **ID** - This is a unique 4 digit identifier specific to this recorder. It is advised to change the ID as all recorders will default to 0001. If Modbus communications are used, it is highly recommended to use the same number as the Modbus slave ID.

When the configuration is complete select the Finish button to Commit, Discard or Commit Later. Select the Back button to return to the previous menu.

Error Alert

(Main Menu > Configure > Setup > Edit Setup > General > Error Alert)

A new alert system has been implemented to allow on screen alerts to be displayed for serious errors and for early warning on potentially serious issues like available media space. When an alert is detected a large message box will be displayed on the screen, it has a flashing border for which colours are user defined and will display the current error state. An acknowledge button is available and a re-flash can be set to warn the user again if the error condition is not rectified.

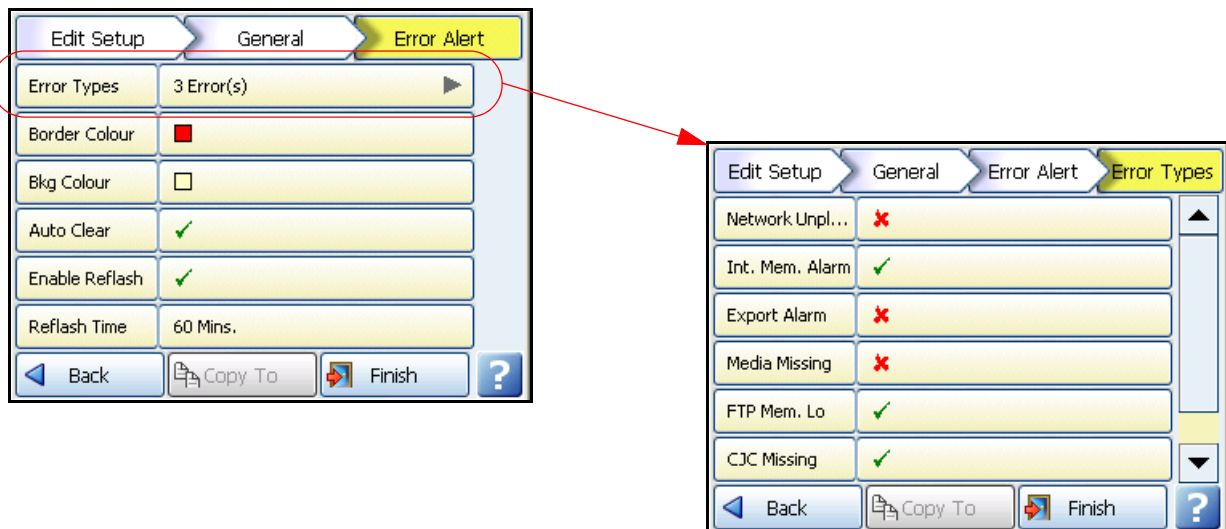

- **Error Types** - The following conditions are available to be enabled:
 - *Network Unplugged* (will detect hub/switch failure also)
 - *Internal Memory Alarm* – Display when internal memory is going to start overwriting non-exported data within a defined period of time. Storage Alarm level must be set.
 - *Export Alarm* – Where external media capacity will run out within a defined period of time. Storage Alarm level must be set.
 - *Media Missing* – External media is missing so a scheduled export is not possible.
 - *FTP Memory Low* - Display when internal memory is going to start overwriting non-FTP'd data within a defined period of time. Storage Alarm level must be set.
 - *CJC Missing* – CJC Sensor is not plugged into AI Card.
 - *TC Burnout* - A TC burnout has been detected.

Storage Alarm Levels need to be set as to when the system is alerted that the three different memory areas as low. This is done in the Edit Recording menu, go to [“Storage Alarm” on page 150](#)

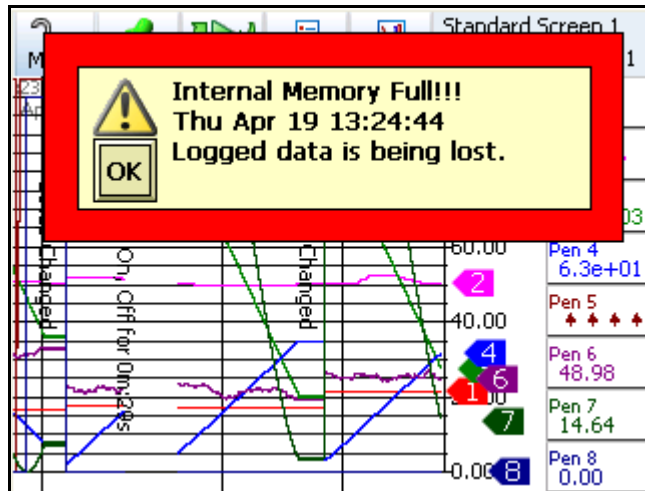

- **Border Colour** - Use the on-screen colour palette to change the message border colour.
- **Background Colour** - Use the on-screen colour palette to change the message background colour.
- **Auto Clear** - When Auto clear is switched on the recorder will automatically detect if something has been done to rectify the problem and the message will disappear. Eg if the removable external storage media being used for a scheduled export is full and is replaced with media that has sufficient memory available then the error alert box will disappear. If Auto Clear is switched off you will be required to press OK on the screen error alert message
- **Enable Reflash** - If Reflash is enabled and a time set the error alert message will appear again at the time specified until the error is resolved. With Reflash enabled pressing the OK button on the screen message will only make the message disappear until the next reflash time occurs.
- **Reflash Time** - Set this to how often you want the error alert message to repeat until the problem is solved.

When the configuration is complete select the Finish button to Commit, Discard or Commit Later. Select the Back button to return to the previous menu.

Display alert as an event effect

This feature is available from within the event system where the Alert Display can be used as an event effect to display a preset or user defined marker. [See “Event Effects \(continued\)” on page 122.](#)

Factory

(Main Menu > Configure > Setup > Edit Setup> General > Factory)

The Factory menu contains information on the Firmware Credit System, Upgrading the recorder Firmware, CJC and Analogue Input Card Calibration, Demo Traces, Reset Setup function and a Localisation menu.



- **Credits** - The Credit menu contains the Serial no. of the recorder, how many credits are available, displays the Options Code and lists what Firmware Options are currently active. [See "Credits" on page 131](#)
- **FW Upgrade** - The Firmware Upgrade button allows new versions of the recorder firmware to be loaded into the recorder. [See "Firmware Upgrade" on page 132](#)
- **Calibration** - Analogue In and CJC Calibration can be performed per slot (card). [See "Calibration" on page 132](#)
- **Demo Traces** - A set of demo traces are available for demonstration or simulation purposes. [See "Demo Traces" on page 135](#)
- **Reset Setup** - Select this to clear the current setup. A Warning message will appear before activating the reset. [See "Resets" on page 136.](#)
- **Localisation** - Set up the recorder for native language use and global settings. [See "Localisation" on page 136](#)
- **Media Config** - contains the list of Storage media with Save and Load Options. [See "Media Config" on page 137.](#)

When the configuration is complete select the Finish button to Commit, Discard or Commit Later. Select the Back button to return to the previous menu.

Credits

(Main Menu > Configure > Setup > Edit Setup> General > Factory > Credits)

The Credit menu contains the Serial No. of the recorder, how many credits are available, displays the Options Code and lists what Firmware Options are currently active.

- **Serial No.** - read only and cannot be edited.
- **Credits** - read only and cannot be edited. It displays the number of Credits available to activate additional firmware functionality.
- **Options Code** - The Options code is a unique coded number for this recorder that contains information that enables certain functionality including the total credit value.

- **Options** - This displays how many credits are currently in use. Select this to produce a list of Firmware options available and their credit values. Toggle each option On or Off to enable the feature within the recorder. If there are not enough credits available. More credits are available from your supplier. For a complete lists of all the firmware options and their functionality see [Table 7.1, “Firmware Options,” on page 241](#)

Firmware Upgrade

(Main Menu > Configure > Setup > Edit Setup> General > Factory > FW Upgrade

The Firmware Upgrade button allows new versions of the recorder firmware to be loaded into the recorder via a USB key or a SD card. The file type required to upgrade the Firmware has the file extension .xsu. Contact **Honeywell** for more information. Firmware downloads are available from <http://www.honeywellprocess.com>

Insert the SD card or USB key with the latest revision of Firmware (.xsu file format) and press the FW Upgrade button. The recorder will scan and check the files on the external device with the current version running in the recorder. Any later version files on the external device are copied into the recorder.

If there is no external media fitted or the file is corrupt a Firmware installation dialog will appear. If this occurs check the file is the correct format (.xsu). Secondly download the file to another SD card or USB key.

See [“Storage Media Format” on page 184](#) for formatting information of SD cards and USB keys. SD card is available as a credit option for the **eZtrend GR**.

Note. The network share folder cannot be used to upgrade firmware remotely. Firmware upgrade needs to be done locally using local USB or local SD card.

To check the firmware upgrade has been successful, see the Status Menu, [“General” on page 195](#).

Calibration

(Configure > Setup > Edit Setup> General > Factory > Calibration)

Cards will be calibrated in the factory. All ranges are factory calibrated and set to the default range of +/-12V. [Table 4.9, “Calibration Input range table,” on page 134](#).

Date & Type of last calibration is stored in [“Maintenance” on page 198](#).

Analogue In and CJC Calibration can be performed per slot (card). Select the AI or CJC calibration button to go to the next menu.

Recommend use of CJC Clips and the Rear Cover to help maintain a uniform temperature around the terminal blocks and cold junction when using thermocouple actuations.

AI Calibration

In this menu there is a button for each Analogue Input card fitted in the recorder. Calibration is done per channel.

Cards may be reset to original ‘factory’ cal, i.e. a card holds two sets of calibration constants (factory & user) for all ranges. [Table 4.9, “Calibration Input range table,” on page 134](#).

Factory Cal - The recorder is calibrated in the factory. These are pre-stored calibration values that cannot be changed by the user. If the recorder is re-calibrated to a User Cal the factory values can be restored at any time.

User Cal - User calibration can be applied at any time. To meet the accuracy values specified (see [“Input Range Performance Accuracy Table” on page 312.](#)), calibration source should be accurate to 0.01% full scale or better.



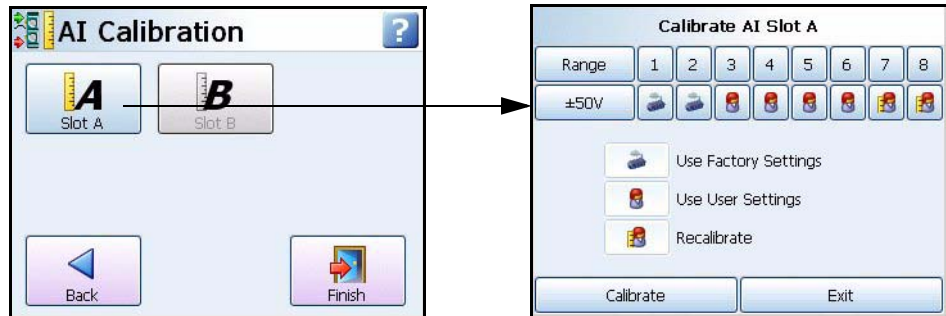

On initial power up the Factory Cal and the User Cal are the same.

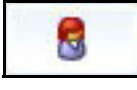

The AI Calibration menu displays a button for each Analogue Input card fitted.

- Select the desired slot button and select the Range required to be calibrated from the drop down list eg. +/-50V.
- Each card has channels numbered 1 to 8. Underneath each channel is the type of calibration.
- Select the button below the corresponding channel number and select the type of calibration from the list, in this case Recalibrate. The Recalibrate icon will appear under that channel.

Table 4.8 : Analogue In Calibration

| | Calibration Type |
|---|------------------|
|  | Factory |
|  | User |
|  | Recalibrate |
|  | Recalibrate All |
|  | Factory All |

- The Calibration Positive Range box appears with instructions to connect the top limit of the input range. Once this is done press the Calibrate button. Next, the Calibration Negative Range box appears instructing the user to apply the bottom range limit. When this is done press the Calibrate button.
- When the calibration is complete the icon changes to the User cal icon under the channel to show that the channel is using the user cal.

Calibration Input Ranges

This table shows which input range is used for each input type.

Table 4.9 : Calibration Input range table

| Input Type | Input Range |
|-------------------|--------------------|
| K Type TC | 50mV |
| R Type TC | 25mV |
| S Type TC | 25mV |
| B Type TC | 10mV |
| J Type TC | 50mV |
| T Type TC | 25mV |
| E Type TC | 100mV |
| N Type TC | 50mV |
| C (W5) Type TC | 50mV |
| G (W) Type TC | 50mV |
| Chrome Copel | 50mV |
| L Type TC | 50mV |
| M Type TC | 50mV |
| P (Platinel) | 100mV |
| D Type TC | 50mV |
| PT100 RTD | 100mV |
| PT200 RTD | 250mV |
| PT500 RTD | 500mV |
| PT1000 RTD | 1000mV |
| Nickel 100 | 100mV |
| Nickel 120 | 100mV |
| Cu10 | 50mV |
| Cu53 | 50mV |
| 200 Ohms | 50mV |
| 500 Ohms | 100mV |
| 1000 Ohms | 250mV |
| 4000 Ohms | 1000mV |
| 0-20mA | 250mV |
| 4-20mA | 250mV |

CJC Calibration

For Thermocouple Input calibration only.

There is a single CJC sensor for each AI card, but the temperature across the connector will not be constant. The CJC calibration allows the user to compensate for temperature gradient.

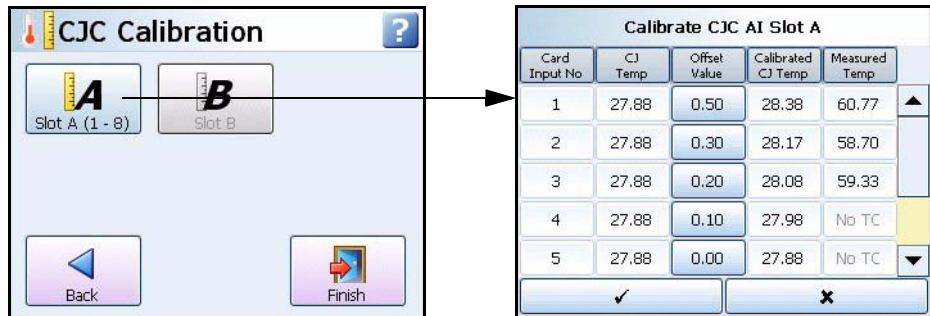

In this menu there is a button for each slot for Cold Junction Calibration. Calibration is performed per slot/card.

- Select the desired slot button. If a CJC connector is not fitted a message box will appear.
- The CJC temperature reading is displayed in the **CJ Temp** column.
- If the known temperature is different to the recorder's reading an Offset can be entered to make an adjustment to future values. The Cold Junction temperature should be measured at the point where the thermocouple is connected in the terminal block. Ensure the measured temperature is accurate to within 0.1°C.
- Enter the difference between the **CJ Temp** on the recorder and the measured reading as the **Offset Value**. The offset is added to all future readings and displayed in the **Calibrated CJ Temp** column.
- The **Measured Temp** column will display the actual temperature using the **Calibrated CJC Temp**, on channels with T/C fitted. For more details of how a thermocouple works, refer to ["Appendix C: Thermocouple Connections" on page 337](#).
- Select the tick box to go back and the Finish button to Commit, Discard or Commit Later.

Demo Traces

(Main Menu > Configure > Setup > Edit Setup > General > Factory > Demo Traces)

A set of demo traces available for demonstration or simulation purposes when no Analogue cards are fitted.

Options for each demo trace are:

- **No Simulation** - Demo traces are deactivated and no simulation traces are available.
- **Simulate if board not fitted** - Simulation is activated when an Analogue In card is not fitted in one of the top two slot positions. Configure the **Demo Setup** in ["Analogue In Menu" on page 73](#).

Resets

(Main Menu > Configure > Setup > Edit Setup > General > Factory > Resets)

Setup

This will remove the current setup from the recorder and return to the default setup. When you select this button the “**Reset Setup Warning**” box will appear with a message: “**Are you sure you want to clear your current setup? This is irreversible and will restart the recorder**”. Select OK to reset the setup or Cancel to ignore and return to the Factory menu.

Layout

This will remove the current layouts from the recorder and return to the default layout. When you select this button the “**Reset Layout Warning**” box will appear with a message: “**Are you sure you want to clear your current layouts? This is irreversible and will restart the recorder**”. Select OK to reset the layouts or Cancel to ignore and return to the Factory menu.

Data

This will remove all log and chart data from the recorder. When you select this button the “**Reset Data Warning**” box will appear with a message: “**This will delete ALL log and chart data, taking approx 80s to complete and will restart during the process**”. Select OK to reset the data or Cancel to ignore and return to the Factory menu.

Reset All

This will remove the current setup, current layouts and chart and log data from the recorder and return to the default setup. When you select this button the “**Reset All Warning**” box will appear with a message: “**This will reset all data including setups, layouts, and chart and log data. This is irreversible and will restart the recorder. Are you sure you wish to continue?**”. Select OK to Reset All or Cancel to ignore and return to the Factory menu.

Localisation

(Main Menu > Configure > Setup > Edit Setup > General > Factory > Localisation)

Set up the recorder for native language use and global settings including:

- **Language** - Select native language menu prompts from list. For French and German the corresponding keyboard layout will be selected.
- **Help Language** - Select native language for Help Files, currently English only available.
- **Time Zone** - Select the corresponding time zone from the drop down list.
- **Daylight Saving** - Toggle On or Off to activate daylight saving, if applicable. When the time zone is selected and daylight saving is active the recorder will change the daylight saving hour automatically. The date this occurs depends on the time zone selected. Some time zones do not have daylight saving. Data being recorded will be affected, either with a 1 hour gap of data or a 1 hour overlap of data.
- **Temp.Units** - Select the Temperature Units that the recorder is set to for temperature measurement. Pen scale units may need to be changed accordingly. See Pen Scale.
- **Line Hz** – Toggle between 50Hz or 60Hz. Mains power frequency. Used to optimise analogue input filtering. Note: The default value is set based on the model number but can be changed here.
- **Paper Size** - Switch between A4 or Letter

Media Config

(Main Menu > Configure > Setup > Edit Setup > General > Factory > Media Config)

This menu contains the list of Storage media with Save and Load Options.

| Edit Setup | General | Factory | Media Conf |
|--------------|---------|---------|------------|
| Load USB 1 | ✓ | | |
| Save USB 1 | ✓ | | |
| Load USB 2 | ✓ | | |
| Save USB 2 | ✓ | | |
| Load SD Card | ✓ | | |
| Save SD Card | ✓ | | |
| Load NAS | ✗ | | |
| Save NAS | ✗ | | |

Back Finish ?

Enable this option if you want to allow user to access specified storage drive or disable (X) if you want to restrict user from accessing the device.

Load NAS, Save NAS - Only available if "User Share Path" is enabled in the Network Admin screen, see ["Network Admin" on page 98](#).

NOTE: If device is already configured for Scheduled Export or Report then user will not be able to restrict access to that device. For restricting access to that media device user need to go Scheduled Export or Report and change the Export device.

Batch Menu

(Configure > Setup > Edit Setup > General > Batch))

Batch is a firmware option that can be activated from “Credits” on page 131.

The Batch function allows the user to segment portions of data for further analysis. Setting up a batch requires information to identify and control batches of data. Batch data can also be paused, for viewing, and resumed. A batch can be aborted at any time, if so this will not register as a batch; a batch is only complete when it has been stopped.

This Batch menu is the setup menu where you can configure all the Batch and Group properties before starting a batch.

Concurrent Batch Mode

Batch mode has changed to allow concurrent batches, where each batch is associated with a group, so all pens within Group 1 will belong to the batch that is controlled by Group 1. Screens can now be set to display groups, in this mode only messages associated with that group (i.e. pens within that group, or batch messages for that group) will be shown on the chart.

Remember when you have set up your batch requirements you need to assign pens to the batch group. Up to 32 Pens in any single batch group.

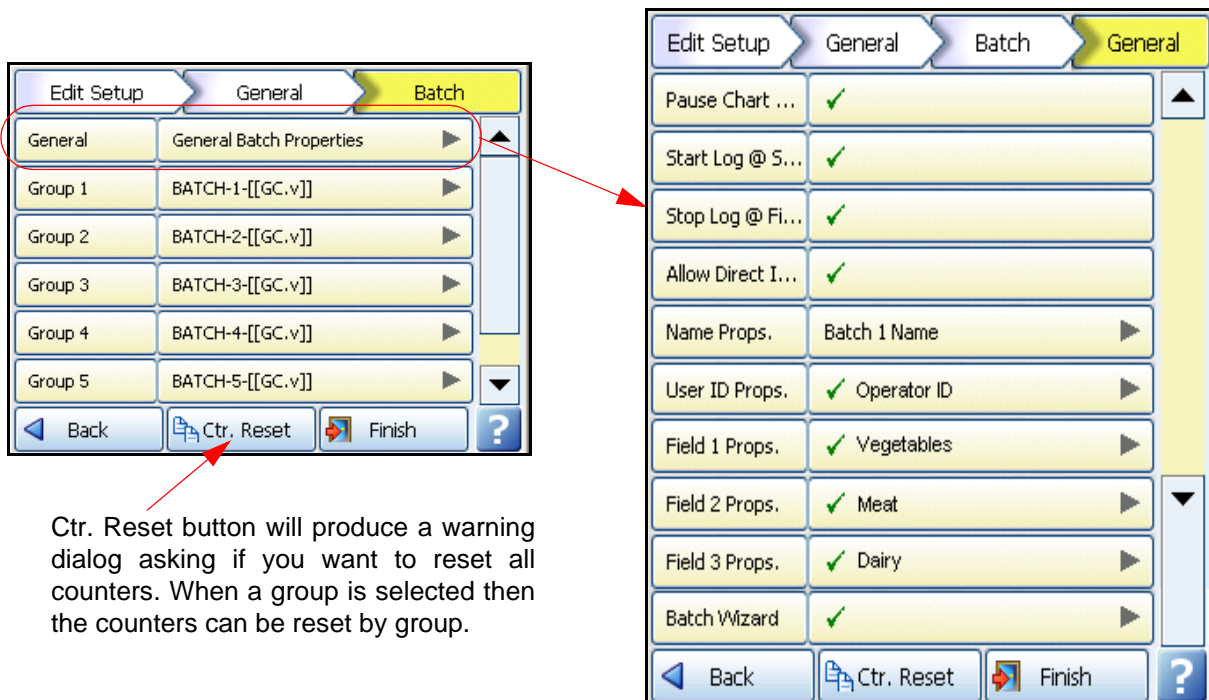

Ctr. Reset button will produce a warning dialog asking if you want to reset all counters. When a group is selected then the counters can be reset by group.

General Batch Properties

- **Pause Chart@Finish** - Enable this if you require the chart to be paused at the end of the batch. The chart will restart when another batch is started for that group.
- **Start Log @ Start** - Enable this if you require logging to start when the batch starts. Batch logging control – Pen logging can be controlled by batch start and stop, the stop and start logging can be independently controlled so a batch could start the pens logging but choose not to stop them logging when the batch stops, or start logging independently of a batch but have all pens stop logging when a batch stops. Only pens within the group of the associated batch will be controlled.

- **Stop Log @ Finish** - Enable this if you require logging to stop when the batch ends. See **Start Log @ Start** for details.
- **Allow Direct Input** - Enable this to allow the Batch control properties (listed below) to be edited directly from the batch control screen. A barcode reader can be plugged into the front of the recorder and the barcodes scanned in directly.

NOTICE

List driven data fields – The next 5 fields are available for data entry associated with a batch. The names can be overridden to suite the end user application, all fields are now 69 character long with the exception of the User ID which is 20. A pre-defined list of up to 30 items can be configured to allow users to select input for these fields from a list rather than type them in every time. E.g. a user might have 8 different products running though the same process, these can be pre-configured so when starting a batch the user can pick from a list of products. The pre-defined lists have to be enabled in the individual group screen, eg. Show *** List.

Sets of functions are available to retrieve the list index from within Maths, allowing state based processing during user selection. See [Figure 14.1, "Maths Variable Table," on page 322.](#)

- **Name Props.** - Enter the name of the batch name and setup a list of additional names to appear as a pick list as a part of the Batch Control screen, see ["Batch Setup/ Batch Groups" on page 180.](#)
- **User ID Props.** - Enable this to make this a requirement when starting a new batch. The User ID display name can be renamed and a list of additional names can be setup to appear as a pick list during the Batch Control setup. If Passwords are active on the recorder then the User ID page will be skipped for user entry and the name of the person logged in through the password system will be automatically entered.
- **Field 1 Props.** - Defaults to Lot. Enable this to make this a requirement when starting a new batch. The Lot number display name can be renamed and a list of additional names can be setup to appear as a pick list during the Batch Control setup. The addition list names will not appear in a drop down list in the Batch Control screen unless you enable Show "n" List in the group properties menu. [See "Group #." on page 140](#)
- **Field 2 Props.** - Defaults to Description. Same as **Field 1 Props** but for Description.
- **Field 3 Props.** - Defaults to Comment. Same as **Field 1 Props** but for Comment.
- **Single Screen Batch** - The Single Screen Batch allows you to view and enter all the batch details on a single screen. If this is not selected the Batch Wizard will enable separate screens to enter the same information. The batch fields are: Batch Name, User Id, Lot Number, Description and Comment are available for viewing and entering details on a single page using the Single Screen batch enabled, if disabled a separate screen will be required for each field. [See "Batch Setup/Batch Groups" on page 180](#)
The Lot number is unique for each batch on a recorder and can be modified by the User. The Lot number starts at 1 and increments by 1 or can be selected from a predefined list. This is irrespective of whether the user is using Batch Wizard or Single Screen Batch to enter the batch details. Groups must be set up, see ["Groups" on page 142.](#)

Group #.

In the Batch menu select a Group #

- **Auto Pop. Wizard** - When enabled this will automatically populate the Batch Control screen with the properties entered into that specific Group.
- **Auto Pop Name** - This is the name of the group that will have its properties populate the Batch Control screen
- **Zero Pad Count** - This refers to the amount of zeros that will be added to the embedded batch counter. Eg. BATCH -2 -[[GC.000001]]. This has to have the same amount of digits to accommodate the largest number the counter will reach, which will be the Roll-over value. If this is not enabled the leading zeros will not be shown.
- **Ctr. Start** - This refers to the number at which the batch counter will start.
- **Ctr. Increment** - This is how much the counter will increase or increment by.
- **Ctr. Rollover** - Enter the number at which you want the counter to reach before it starts again.
- **Show *name* List** - (only appears when Auto Pop Wizard is off). Enable this to allow any additional list item names to appear in a drop down list in the Batch Process screen. *See below.
- **Show User *ID* List** - enable this to allow any additional list item id's to appear in a drop down list in the Batch Process screen. *See below.
- **Show Lot No. List** - Add a batch Lot No., if required (up to 11 characters)
- **Show Desc List** - Enter a description of what the batch is (up to 17 characters)
- **Show Comment List** - Add any further comments

NOTE: Batch mode no longer operates on pens that do not belong in a group, so when upgrading to the new version existing users need to add pens to a group to use the batch functionality.

Batch process screen

To show a batch related process screen the screen must be configured to display the group being used for that batch. Under the message count icon it will show the current status for the batch related to that group. The message list status bar will also show the Batch name, state and group name in rotation with the date/time display. An extra button is now available within the message button on the status bar to show the current status of the batches for all groups.

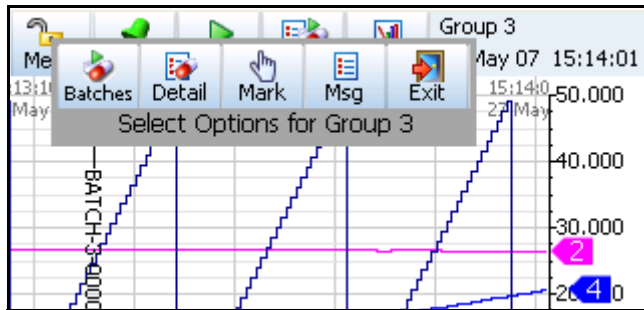

Note: on non batch screens the message list icon no longer shows the batch state as there are potentially 6 batches running in different states

Printer Menu

(Configure > Setup > Edit Setup > General > Printer)

The Printer function is a firmware option that is selectable from the Factory menu > “Credits” on page 131. The screens that currently can be printed are all Status screens, Message lists, Process screens and Replay screens.

The printer network information should be entered prior to printing, see “Network Admin” on page 98. If the information is not entered in the Network Admin menu a dialog box will appear prompting you to enter Username, Password and Domain. Entering this information into the dialog will not populate the Network Admin menu. It is recommended that you fill in this information into the Network Admin menu as it will not be affected by Firmware upgrades in the recorder.

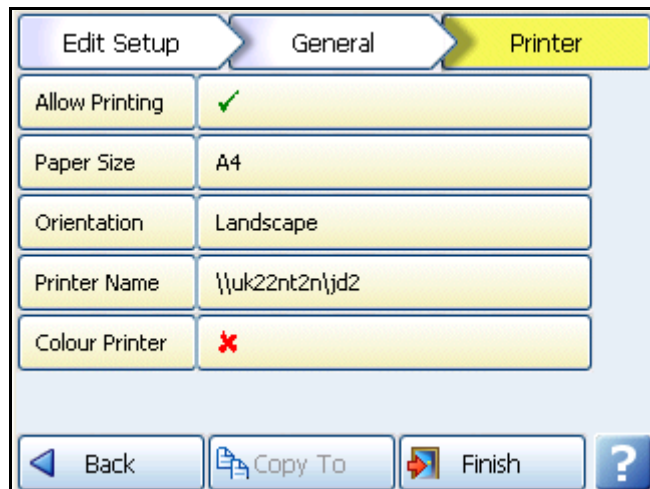

The Printer menu allows configuration for setting up a printer. The printer option displays a Print button from various screens using a basic USB standard PCL (Printer Command Language) printer. For details on suitable printer types see “Print Support (USB 2.0)” on page 44.

- **Allow Printing** - Tick to enable On and Off
- **Paper Size** - Toggles between A4 and Letter

- **Orientation** - Toggles between Landscape and Portrait
- **Printer Name** - Enter the printer name as found on the network. For a local printer that is connected directly to the recorder via USB, ensure the printer name is set to the default (LPT1:). If the printer is to be a network connected printer the printer name would be the IP address or network path to the printer, so a configuration like "\pa62NT001\printer name" might be used.
- **Colour Printer** - Tick if a colour printer is being used for the screen capture facility. Screen captures can be printed as an Effect of an Event. [See "Events - Cause and Effect" on page 113.](#)

If in doubt, contact your IT Administrator for advice.

When complete go to Finish > Commit to implement the new set up

Groups

(Configure > Setup > Edit Setup> General > Groups)

This menu is used for re-naming the groups. Groups are used as a part of the concurrent batch system. Each batch is associated with a group, pens are assigned to a group and all the pens within group 1 will belong to the batch that is controlled by group 1. [See "Batch Menu" on page 138.](#) Up to 32 Pens in any single batch group.

The same pen can only be associated with one group. To add a pen to a Group see ["Pens Menu" on page 84.](#)

Groups of pens can also be used in order to:

- Acknowledge Alarms in pen groups
- Reset Max/Min, Reset Max or Reset Min in pen groups
- Start, Stop and Reset Totals in pen groups

When the configuration is complete select the Finish button to Commit, Discard or Commit Later. Select the Back button to return to the previous menu.

Screen Menu

Screen Setup

(Main Menu > Configure > Setup > Edit Setup> Screen)

Set up the recorder's screen configuration.

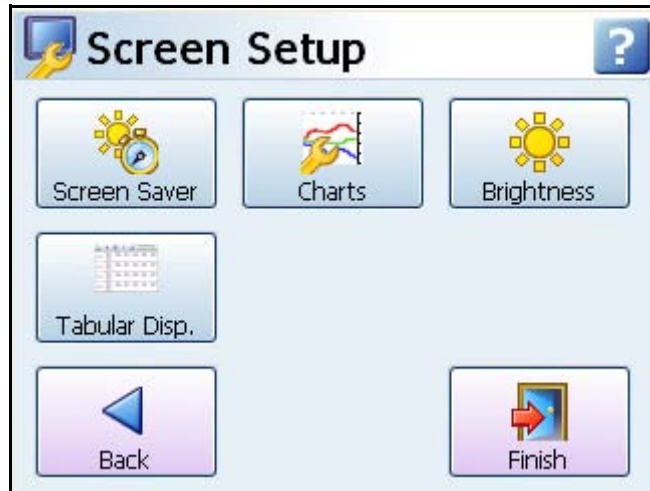

- **Screen Saver** - In this menu you can configure the Screen Saver functions. [See "Screen Saver" on page 143](#)
- **Charts** - In this menu you can set the Fast, Medium and Slow chart speeds. [See "Charts" on page 144](#)
- **Brightness** - Adjust the brightness of the screen using the instant brightness slider. [See "Brightness" on page 145](#)
- **Tabular Display** - Configure Tabular Screen Display.

When the configuration is complete select the Finish button to Commit, Discard or Commit Later. Select the Back button to return to the previous menu.

Screen Saver

(Main Menu > Configure > Setup > Edit Setup> Screen > Screen Saver)

Configure the screen display and Screen Saver functions. The default state for the Screen Saver is disabled. The Screen Saver function helps to reduce backlight wear. When active, the back light is off and nothing on the display is visible. The screen saver will not function in Setup Menus or in test mode.

- **Enabled** - Toggle On and Off.
- **Timeout** - Only available when the Screen Saver function is active. This is how long the Screen Saver will display on the screen. Programmable between 1 and 720 minutes in software, when disabled the screen will remain on permanently (enter 0 to disable).
- **Saver Type** - Only available when the Screen Saver function is active. This is set to Normal.

- **Dim Saver** - Only available when the Screen Saver function is active. Dim Saver will help to increase the life of the backlight and lower the screen brightness for night time use. Use Saver Brightness or Off Always.
- **Saver Level** - Only available when the Dim Saver function is set to Use Saver Brightness. Select this to use the instant dimming slider which lowers the screen brightness. Default screen brightness is 80%. Adjustable between 10% and 100% of full brightness. Normal backlight MTBF at 100% brightness is 50,000 hours at 100% brightness (operating at 25°). For backlight life and brightness see [“Specification Tables” on page 307](#)

When the configuration is complete select the Finish button to Commit, Discard or Commit Later. Select the Back button to return to the previous menu.

Note. Once you enable the screen saver it will **not** turn off the backlight if at the time of the Timeout there is a pen in alarm. The screen will stay on until the alarm is gone and the Timeout is passed. Once the Saver is active and screen is Dark (backlight is off), it will turn back on if a pen goes into alarm.

Exit Screen Saver

If the screen saver is active on the recorder, any of the following will deactivate the screen saver:

- User touches the recorder screen.
- Any USB device is plugged in or unplugged.
- On alarm - An alarm is triggered, the unit will not return to screen saver till the alarm state is inactive and another screen saver time-out period has expired.

Charts

(Main Menu > Configure > Setup > Edit Setup> Screen > Charts)

The Chart Speed sets how fast, in mm/hr the chart moves across the screen. The recorder has 11 different chart speeds. There are 3 categories that can be set; Slow, Medium and Fast. From each of those categories the actual speed of the chart can be selected.

Figure 4.12 Strip Chart Speed selection

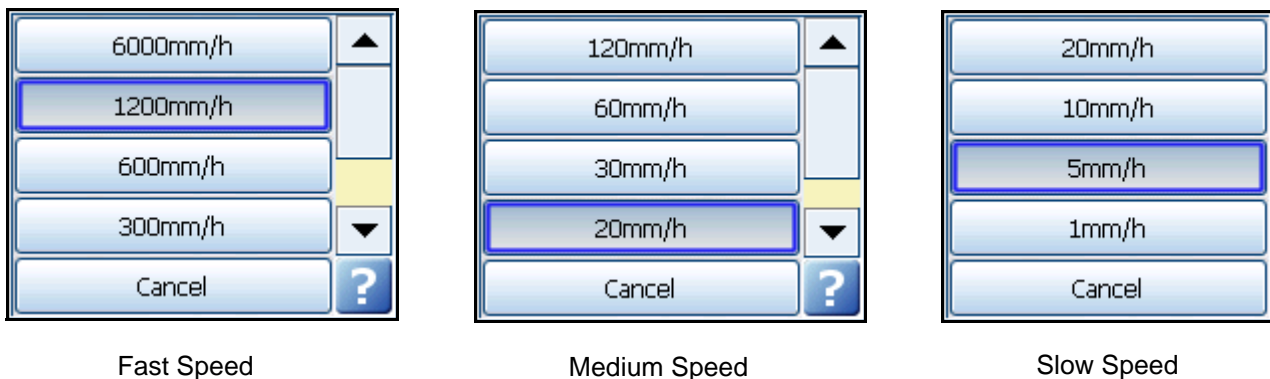

- **Fast Speed** – 60mm/h, 120mm/h, 300mm/h, 600mm/h 1200mm/h and 6000mm/h
- **Medium Speed** - 10mm/h, 20mm/h, 30mm/hr, 60mm/hr and 120mm/h
- **Slow Speed** – 1mm/h, 5mm/h and 10mm/h, 20mm/h

Once the charts speeds have been set up in the strip for circular chart menu go to a process screen displaying data on a chart and touch the screen. This will activate the Settings menu in the top right of the screen, select this to display the 3 categories set. [See “Chart Speeds” on page 235.](#)

Circular Chart Speed Selection



Circ Fast Speed – the required to fill circular chart data in 1 hr.

Circ Med Speed - the required to fill circular chart data in 1 day.

Circ Slow Speed – the required to fill circular chart data in 1 week.

Hour Alignment – the alignment hour for daily charts

Day Alignment – the alignment day (Sunday = 0, Monday = 1, etc.) for week charts.

When the configuration is complete select the Finish button to Commit, Discard or Commit Later. Select the Back button to return to the previous menu.

Brightness

(Main Menu > Configure > Setup > Edit Setup> Screen > Brightness)

Set the recorder’s screen brightness using the instant brightness slider. Default screen brightness is 80%. Adjustable between 10% and 100% of full brightness.

Set the brightness level, tick to agree, then go to Finish, Commit to permanently apply the change.

For information on increasing the display life by reducing backlight brightness see [“Backlights” on page 301.](#)

Tabular Display

(Main Menu > Configure > Setup > Edit Setup> Screen > Tabular Display)

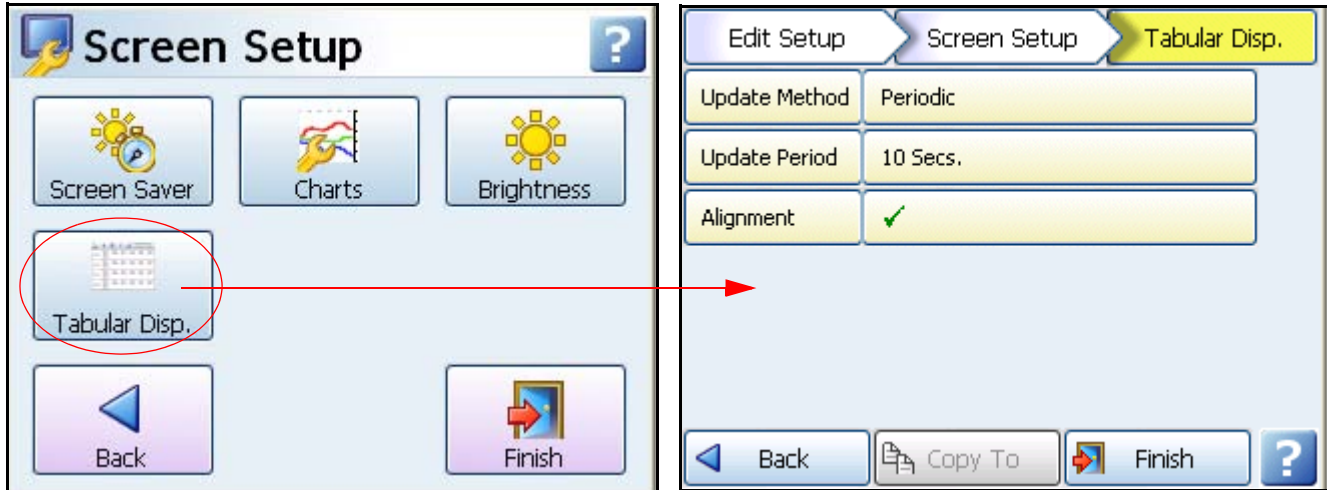

- **Update Method** - Periodic or Event
- **Update Period** - Configuration of periodic display can be set from 10 seconds (default) per update to 86400 secs (or 1440 minutes = 1 day) per update, this will show a new line of data readings at this elapsed time period.
- **Alignment** - an align configuration would be provided to align the tabular display to the nearest minute or hour.

Tabular Screen

Main Menu > Screen > Edit > Screens
(or Main Menu > Configure > Layout > Edit > Screens.)

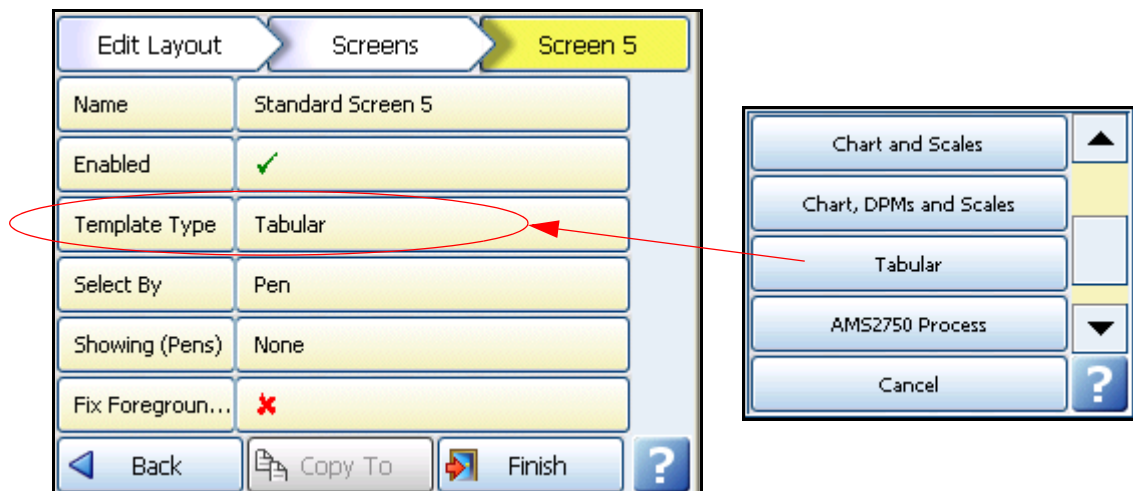

A Tabular screen will display tabular readings in lines from top to bottom of the screen, with the latest readings at the top of the screen.

The template will auto size for **Minitrend**, **eZtrend** and **Multitrend** recorders, allowing 6 pen values per line for a **Minitrend** and **eZtrend** , and 12 pen values per line for an **Multi-trend** . Spacing will be fixed so that there will always be room for 6 and 12 per line on default screens, custom screens can be created to display more.

Up to 32 pens can be configured to be displayed on the tabular display screen as with other canned screens.

An Event Effect can be setup whereby the tabular readings can be updated each time it was triggered.

If the recorder is put into Replay mode the standard chart replay screen will be shown.

| Standard Screen 4 | | | | | | |
|-------------------|------------------|------------------|------------------|------------------|--------------------|------------------|
| Menu | 0 | 25d | 5 | Screen | 29 Aug 08 13:52:41 | |
| 29 Aug 13:52:39 | 1:Pen 1 55.49 | 2:Pen 2 97.00 | 3:Pen 3 14.92 | 4:Pen 4 84.21 | 5:Pen 5 28.27 | 6:Pen 6 81.37 |
| 29 Aug 13:52:29 | 1:Pen 1 70.57 | 2:Pen 2 87.00 | 3:Pen 3 14.13 | 4:Pen 4 81.40 | 5:Pen 5 25.94 | 6:Pen 6 81.46 |
| 29 Aug 13:52:19 | 1:Pen 1 83.65 | 2:Pen 2 77.00 | 3:Pen 3 13.49 | 4:Pen 4 80.87 | 5:Pen 5 26.11 | 6:Pen 6 77.67 |
| 29 Aug 13:52:09 | 1:Pen 1 93.43 | 2:Pen 2 67.00 | 3:Pen 3 15.81 | 4:Pen 4 81.71 | 5:Pen 5 21.80 | 6:Pen 6 83.00 |
| 29 Aug 13:51:59 | 1:Pen 1 98.96 | 2:Pen 2 57.00 | 3:Pen 3 11.36 | 4:Pen 4 82.42 | 5:Pen 5 22.65 | 6:Pen 6 82.13 |
| 29 Aug 13:51:49 | 1:Pen 1 99.70 | 2:Pen 2 47.00 | 3:Pen 3 12.19 | 4:Pen 4 82.88 | 5:Pen 5 22.04 | 6:Pen 6 82.87 |
| 29 Aug 13:51:39 | 1:Pen 1 95.57 | 2:Pen 2 37.00 | 3:Pen 3 12.45 | 4:Pen 4 82.32 | 5:Pen 5 20.10 | 6:Pen 6 82.42 |
| 29 Aug 13:51:29 | 1:Pen 1 86.98 | 2:Pen 2 27.00 | 3:Pen 3 11.71 | 4:Pen 4 80.50 | 5:Pen 5 17.21 | 6:Pen 6 87.51 |

Edit Recording

(Main Menu > Configure > Setup > Edit > Recording)

Scheduled, see below

[“Storage Bias” on page 149](#)

[“Storage Alarm” on page 150](#)

[“Pre-Trigger” on page 151](#)

[“Export Format” on page 152](#)



Scheduled

(Main Menu > Configure > Setup > Edit > Recording > Scheduled)

Set up Scheduled exports to transfer data at timed intervals, from internal flash memory to externally attached devices, SD card or USB storage key. SD card is available as a credit option for the **eZtrend GR**.

Note. The use of the network folder for Scheduled export is not recommended since network connectivity and network problems could result in the risk of missing data due to the Scheduled export not being performed at the scheduled time and the folder. It is advisable to use other media (USB, SD card) for scheduled export.

See [“Recording Methodology” on page 184](#) and [“Storage Media Format” on page 184](#).

Select the Scheduled button to reveal the scheduled menu.

Schedule Export - Tick to enable.

Export Device - Select the device you wish to export data to. USB1 is the first USB device to be fitted and USB2 is the second one fitted, front or rear of the recorder. SD card is available as a credit option for the **eZtrend GR**.

A network share path may be available here if configured, but use USB or SD card for scheduled export if possible. See note above.

Update Period - Select how often you wish data to be exported from the list provided; 10, 30 minutes, 1, 2, 12 or 24 hours.

Log Messages - Tick to add a message to the messages list when a scheduled export has been performed

Mark Chart - Only active when Log Messages is enabled. Tick to mark the chart when a scheduled export has been performed.

When the configuration is complete select the Finish button to Commit, Discard or Commit Later. Select the Back button to return to the previous menu.

If a manual Export Now is in progress during the time when a Scheduled export is to occur, the scheduled export will hold off until the manual export is finished.

Storage Bias

(Main Menu > Configure > Setup > Edit > Recording > Storage Bias)

An adjustable slider can be used to determine how much internal flash memory is allocated for storing chart data and how much internal flash memory is allocated to storing logged data. The User can adjust the slider to increase and decrease the internal flash memory storage allocation.

Displayed under the Total Available Space bar is the amount of internal flash memory allocated to chart and log data. This will update as you move the slider. The amounts shown display how much time it will take to fill the internal flash memory allocations, at the current chart speed, before the data will start to be recycled.

The default for the slider, time coverage wise, is set to a bias in the recorder to initially provide more space for data storage than chart replay. You should set the bias to what best meets your data storage vs. chart replay requirements. The recorder is set to balance, time coverage wise, the chart and logged data equally depending on how many pens are enabled and what current chart speeds are set.

As you move the slider to the right, towards Chart, you will notice the allocated internal flash memory space for the chart data will increase in the bar above the slider. As you move the slider to the left, towards Log, you will notice an increase in the internal flash memory for the Log data in the bar above the slider.

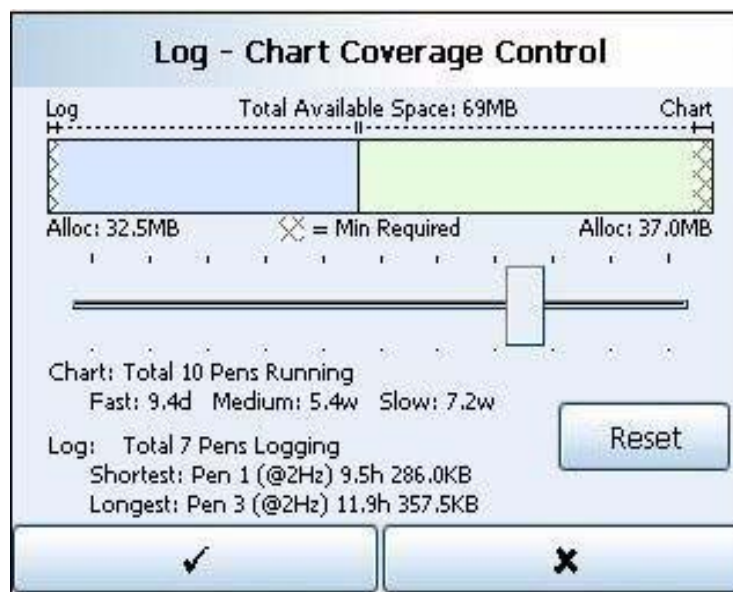

Default Storage Bias screen

The Total Available Space bar also contains minimum chart and log memory allocation, this is shown in the hatched areas at both ends of the bar. You cannot use this reserved internal flash memory.

The Reset button will return the slider and the memory allocation to its original position when you entered the Storage Bias screen.

The screen also shows chart information regarding how many pens are currently enabled and how much time it will take to fill the chart memory depending on the chart speeds selected. When you move the slider to increase the chart memory the amount of time to fill the chart memory will also increase. If you decrease the chart memory, thus increasing the log memory, the amount of time to fill the chart memory, ie. chart history, will decrease accordingly. Note that as you allocate more chart memory the recorder gives preference to medium and slower chart speeds.

The log information displays how many pens are currently set for logging/recording. The shortest pen means the pen that will take the shortest amount of time to fill it's part of the log memory before it starts recycling, that is, overwriting the oldest data with the newest. The longest pen is the pen that will take the longest amount of time to fill it's part of the log memory before it starts recycling. The recorder will, where possible, balance the times so the shortest and longest pens fill the log memory at approximately the same time. Depending on the different log rates, the allocation of memory will vary per pen.

When the configuration is complete select the Finish button to Commit, Discard or Commit Later. Select the Back button to return to the previous menu.

Internal SD Memory

The SD card is the internal memory architecture inside the recorder which has two partitions. One partition has OS image, used by the recorder, and the size reserved for this partition is 256MB (fixed). The second partition is available space for use. So for example a 1GB card then 256 MB is used by recorder for storing OS image and is never released for use.

NOTICE

Because pens only begin to use extra memory when it is required there will be some delay in how quickly other screens update the memory allocation information. Eg. the Recording screen will adjust "Export Required In" time depending on chart speeds, pens rate and how far the slider is moved.

Storage Alarm

(Main Menu > Configure > Setup > Edit > Recording > Storage Alarm)

The storage alarm function is linked to the Error Alert system when there is a requirement for a time period to be set to alert the user before the storage media is full.

- **Internal memory** - Set the amount of time before the internal memory becomes full and data is lost and for the Error Alert Message to display on the screen. Enter a time period of between 0.5 and 48 hours.
- **Export media** - Set the amount of time before the data being exported to a media becomes full, and data is lost, for the Error Alert Message to display on the screen. Enter a time period of between 0.5 and 48 hours.

- **FTP Memory** - Set the amount of time before the FTP memory becomes full, and data is lost, for the Error Alert Message to display on the screen. Enter a time period of between 0.5 and 48 hours.

When the configuration is complete select the Finish button to Commit, Discard or Commit Later. Select the Back button to return to the previous menu.

Pre-Trigger

(Main Menu > Configure > Setup > Edit > Recording > Pre-Trigger)

The pre-trigger functionality function captures a high resolution trend leading up to an event triggered by an alarm, and optionally after the event (Post-Trigger), where the information can then be viewed in **TrendManager Pro** for analysis.

Configuration

The pre-trigger system is simply configured by selecting which pens they wish to be included in the pre-trigger by enabling the Pre-Trigger item in the pen logging menu, [“Logging Menu” on page 86](#), and setting the desired pre-trigger time which is common to all pens, this is done here in the recording menu.

- **Pre-Trigger Time** - The pre-trigger system can be configured to allow between 1 and 10 minutes at whole minute increments of pre-trigger data to be stored for each pen, each pen will store the same time span. The default will be set to 5 minutes.
- **Post-Trigger Time** - specified in seconds from 0 (disabled and the default) to 3600 for 1 hour of post trigger time, extending the alarm log rate for all pre-trigger pens by the specified time after the last pre-trigger pen alarm has cleared.

Acquiring

In the running state the pre-trigger buffers are being filled with pen readings dependant on the alarm logging rate when no pre-trigger pen alarms are asserted. The buffer will cycle when they reach the maximum pre-trigger time as configured.

If power is lost when the pre-trigger is acquiring then the pre trigger information will be lost.

Event processing

All pens enabled for pre-trigger will be put into their alarm logging rate and remain in the alarm logging rate while any pre-trigger pen alarm is asserted.

Once one or more alarms on a pre-trigger enabled pen(s) fire, the readings in the pre-triggered buffers will be saved to internal flash memory. The pre-trigger system will request an export to be performed if scheduled export is enabled. If Post-Trigger is enabled, the alarm log rate will continue for this period after all alarms have cleared.

If during the post trigger time a pre-trigger alarm re-occurs, but the previous pre-trigger event has not been exported then the post trigger timer will be reset and will start again after all pre-trigger alarm have cleared.

Pre trigger information is only secure when it has been saved into the internal flash memory or exported.

Export

The pre-trigger files are exported from the internal flash memory via the scheduled or manual export to the externally selected device, OR when an FTP download occurs. The pre-trigger data is appended to the Pen data files during export.

It is recommended to set up a scheduled export as the pre-trigger files will only be exported once and to the first device on which an export occurs following a pre trigger event occurring.

If power fails when the pre-trigger information is waiting to be exported or is being exported, then the system will restart into the export state, allowing the files to be exported. If the power fails before the Pre-Trigger alarm is activated data will be lost and the recorder will restart.

Restart

Once the files for a pre-trigger have been exported and all alarms on pre-trigger enabled pens have cleared, the pre-trigger buffers are reset and the existing pre-trigger information has been exported, then the system returns to the acquiring state.

If a configuration change is performed then the pre-trigger system will be restarted, the user will be warned before committing that they will restart the pre-trigger buffering, if an export is pending they will also be asked to perform the export procedure or lose the existing pre-trigger information.

Importing

Once exported, the import into **TrendManager Pro** can be performed from removable media or via FTP, the imported information will show the pre-trigger pens as overlapped data. This will automatically be displayed utilising the **TrendManager Pro** overlapped pens feature to clearly show the pre-trigger data. See **TrendManager Pro** software manual.

Export Format

(Main Menu > Configure > Setup > Edit > Recording > Export Format)

Export Format decides the format in which the logged data is to be exported to the client. There are two options:

- **TV Encryption Scheme:** Exports the data as DAT files. The client then uses the **TrendManager Pro** to analyze the data.
- **CSV format:** The CSV format exports all or new data based on the selected option in CSV format. This data is can be exported to the client using USB or SD card. The data is useful to the client who does not wish to use **TrendManager Pro** .

Note: If the CSV data is huge in several MBs like more than 50MB it may take more time to export. It is recommended to use the schedule export once or twice a day to avoid huge accumulation of data.

Reports Menu

(Main Menu > Configure > Setup > Edit > Reports)

Reports can be generated manually or on a periodic basis using the event system to show daily/weekly/monthly totals, max mins, averages etc., the reports can be printed, e-mailed as attachments or exported to the external media. The reports will be in RTF format for use in MS Word™ or other compatible word processors.

A batch report for a Temperature Uniformity Survey can be produced.

Before a report can be run the report menu must be configured. In the Reports Menu select the first or next available Report #.

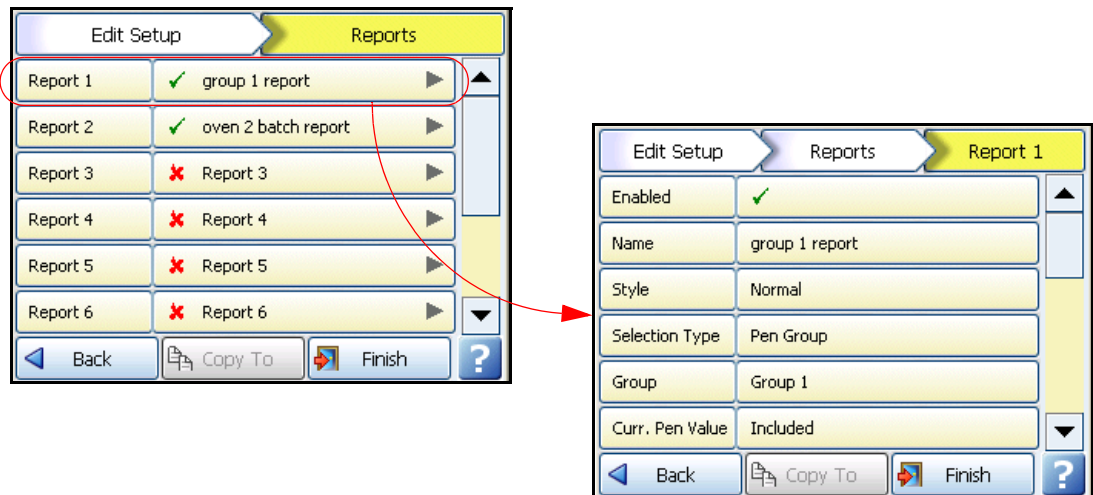

Enabled - Set to a tick to enable

Name - Enter an identifiable name of your report

Style - Select Batch for running reports on current batches. Select Normal to run reports on specific pens, all pens or groups. A TUS report is for a Temperature Uniformity Survey that can only be used if this option is enabled in the credits menu.

This type of TUS report is condensed and should not be used as the final report to comply with AMS2750 specifications. The full report for a TUS should be generated using the TUS procedure following [“Appendix L: GR Series AMS2750 capabilities” on page 377](#).

Selection Type - This will be set to Group if Batch is selected for the Style, select which group of pens the report will be run on. If the Style is set to Normal the following options will be available:

- **Multiple Pens** - This allows you to select which pens to run a report on including Totaliser pens
- **Pen Group** - Allows you to select which group of pens to run a report on
- **All Pens** - This will run a report on all the currently enabled pens

Group - (only available when Pen Group is selected for Selection Type). Select the Pen Group you wish to run a report on from the available groups list. To have groups of pens available in this list, individual pens must be allocated to a group, see Group in the [“Pens Menu” on page 84](#). Use Group to produce an AMS2750 summary report.

Current Pen Value - Select whether to include the Current Pen Values, of enabled pens, in your report.

Max/Mins - Select this to include the Maximum and Minimum values of each selected pen, All pens or Group of pens depending what has been chosen in the Selection Type option. The report can give you the pen Max/Min value for every Hour, Day, Week, Month, the Current max/min pen value or Do Not Include Max/Min values.

Averages - Select this to include the Average values of each selected pen, All pens or group of pens depending what has been chosen in the Selection Type option. The report can give you the pen Average value for every Hour, Day, Week, Month, the Current average pen value or Do Not Include Average values.

Pens - Pens - (only available when either Current Pen Value or Max/Mins is set to Included). Select which pens this report will be run on.

Totals - Select this to include the Total values of each selected pen, All pens or group of pens depending what has been chosen in the Selection Type option. The report can give you the pen Total value for every Hour, Day, Week, Month, the Current total pen value or Do Not Include Total values.

Totaliser Pens - (only available when Multiple Pens is selected for Selection Type). This will display any pens that have been set up as a totaliser pen. [See "Displaying Totals" on page 93.](#)

Messages - Select this to include the Messages of each selected pen, All pens or group of pens depending what has been chosen in the Selection Type option. The report can give you the pen Messages for the Last Hour, Last Day, Last Week, Last Month, All messages or Do Not Include Messages.

Message Lists - Select which type of messages are required for your report: Alarm, System, Diagnostic, Security or User messages. One or more selections can be made. For more information see ["Message Types" on page 187.](#)

Counters - Select which type of Counters are required for your report: Alarm, User, Event, Digital, Digital Input, Relay Output or Pulse. One or more selections can be made. For more information see ["Events/Counters" on page 111.](#)

Include Digital Inputs - Select to Include or Do Not Include this option.

Include Digital Outputs - Select to Include or Do Not Include this option.

Footer Style - Choose between one or two lines of footer at the end of the report. The extra footer lines give you the option to add fields, such as "Checked By" and "Date" etc. See [Figure 4.8 on page 193](#)

Email - Tick to enable the Email function. See [Figure 4.8, "Email Report example," on page 193.](#) The report is sent as a Word document and to view all the options eg. Footers you may have to change your View to see these options (View > Print layout).

Recipients - (only available when the Email function has been enabled). Select from a list of email recipients. Email addresses and Server names must be entered in ["Email" on page 106.](#)

Print - Set to a tick to enable the Print function. The printer settings must be set up before this feature will operate, see ["Printer Menu" on page 141.](#)

Export Device - Select from a list of options if you require your report to be exported to an external media device (SD card/USB key), Network Share folder (NAS) or select Do not export. The removable media device needs to be fitted to the recorder when the report is run and have enough memory available.

To Export to a NAS folder "Use Share Path" needs to be set up in ["Network Admin" on page 98](#) and NAS devices enabled in ["Media Config" on page 137.](#)

When the configuration is complete select the Finish button to Commit, Discard or Commit Later. Select the Back button to return to the previous menu.

Run a Report

Once the report details have been completed in the report menu you can run your report either manually or by using the Event system.

- For a manual report see [“Reports \(Process\)” on page 192](#).
- For a report triggered using the Event system see [“Event Effects” on page 119](#).

Pen Report Information

Currently pens provide real-time values, max, min and totals. Reports need some history of these values to be maintained, so a set of period based data is maintained. The periods being an hour, day, week and month. The recorder builds up the current hour, day, week and monthly data and keeps the previous (completed) hour, day, week and month stored.

At any time it is possible to access the current hour, day, week or month for Max, Min, Average and Totals, also you can get access to the previously complete whole hour, day, week or month for each pen.

- An hour is a whole hour starting on the hour eg. 10.00 to 11.00
- A day starts at one second passed midnight.
- A week starts one second passed midnight on Sunday
- A month starts at one second passed midnight on the 1st of the month

Access to this is provided automatically via reports but this information can also be included in maths/scripts and by using embedded variables.

Examples below:

Pen Report Maths

In maths the following syntax is available:

prmax[x,y,z] = Pen report Max value

prmin[x,y,z] = Pen report Min value

prave[x,y,z] = Pen report Average value

prtot[x,y,z] = Pen report Totaliser value

where ...

x = Pen Number 1 to 96

y = period 1 = Hour, 2 = Day, 3 = Week, 4 = Month,

z = report set 1 = Current, 2 = Previous completed

e.g. **P1 =prmax[23,2,1]** - Max value so far for current day for Pen 23

Continued on next page

Pen Report Syntax

the syntax for the embedded variables is as follows:

[[PRPtttxynn.v]]

ttt is the type of variables required and can be

MAX = Max value

MAT = Time max value was recorded

MIN = Min Value

MIT = Time min value was recorded

AVE = Average Value

TOT = Totaliser value

STM = Start time of the reports set

x is the report set and can be

C = Current working hour, day, week, month

L = Last completed hour, day, week, month

y is the period and can be

H = Hour

D = Day

W = Week

M = Month

nn is the pen number from 1 to 96

e.g. of some embedded variables

[[PRPTOTLM1.v]] Total for last complete month for pen 1

[[PRPMAXCD23.v]] Max so far for current day for pen 23

[[PRPMATCD23.v]] Time max was recorded for current day for P23

[[PRPSTMCD23.v]] Start time of report for current day for pen 23

Layout

(Main Menu > Configure > Layout >)

The user can configure how the data is presented on the screen. From the Layouts screen choose to Edit, Save or Load layouts in the recorder.

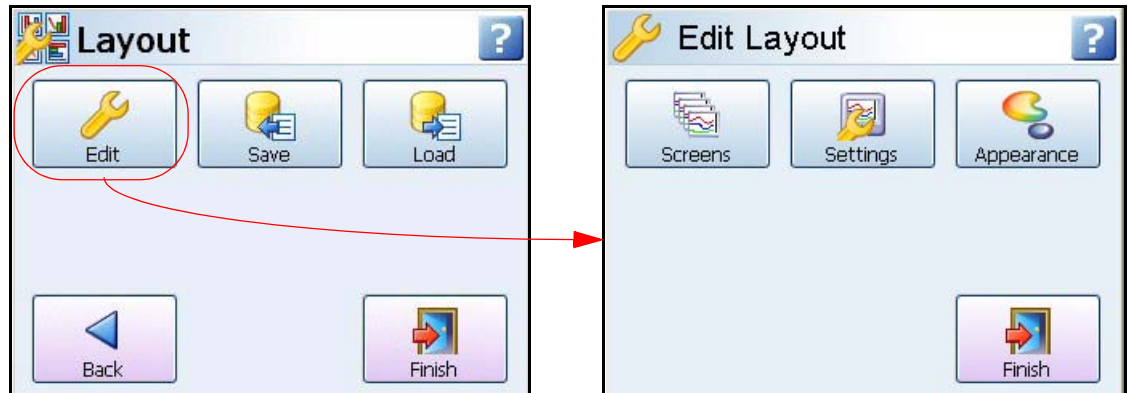

Edit Layout

(Main Menu > Configure > Layout > Edit)

The Edit Layout menu displays a Screen button to enable and display Standard and Custom screens. The Settings button is used to enable screen cycling, alarm screens and replay screens. The Appearance button is used to change the chart background colour for normal charts and charts in replay mode.

Screens

(Main Menu > Configure > Layout > Edit > Screens)

This section allows the user to configure and modify the standard screens on the recorder. The Edit button will produce a list of available screens in the recorder. In each screen you can enable, check and change the screen properties.

The Edit button may display a warning message if the Commit Later option has been selected. This means changes to the configuration have been made but the changes have not been committed to the recorder. [See "Commit Later" on page 206.](#)

Select a standard or a new screen to view the following menu list:

- **Name** - Select to Change the name of the Standard Screen. 21 characters max, including spaces.
- **Enabled** - Toggle On and Off to activate this Standard Screen
- **Template Type** - Select from a list of pre-defined templates.
 - *DPMs* - Select which pen is displayed. Activate to display Max/Min readings and/or activate to display Total values
 - *DPMs and Bars* - Select which pen is displayed. Activate to display Max/Min readings and/or activate to display Total values
 - *Charts and DPMs* - Select which pen is displayed.

- **Charts and Scales** - Select which pen is displayed. Select and activate which scale is required to be displayed.
- **Charts, DPMs and Scales** - Select which pen is displayed. Select and activate which scale is required to be displayed.
- **Tabular** - Select which pens are to be displayed in a table style layout. See [“Tabular Screen” on page 146](#).
- **Circular Chart and DPMs** - Select which pens are to be displayed in a circular and DPM style layout. Available for **Multitrend GR** and **DR Graphic**.

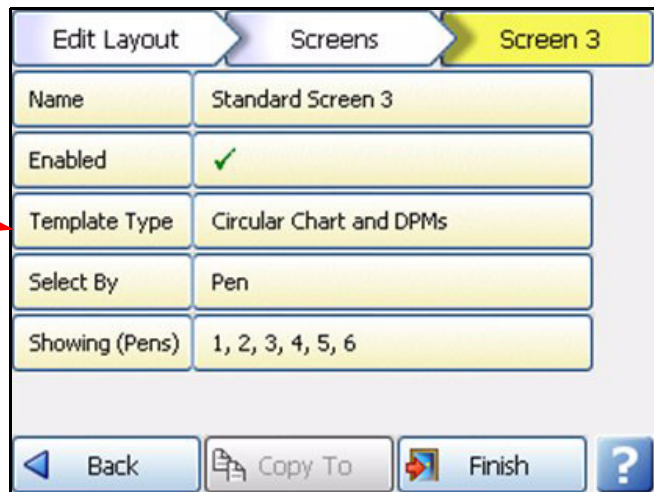
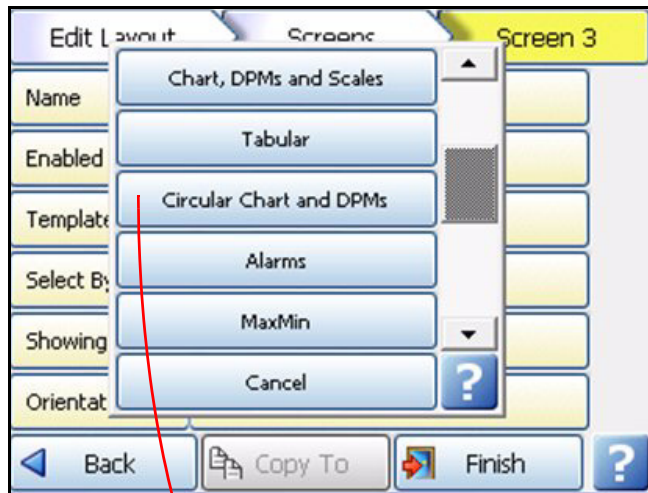

- **AMS2750 Process** - This screen is required when the recorder is being used in AMS2750 Process Mode. Refer to [“AMS2750 Process Menu” on page 379](#).
- **Template #** - If a template is being used it will appear here
- **Alarms** - Select by either Pens or Groups. Showing either the pen numbers or the Group name. Maximum 32 pens per group for **Multitrend GR**, 16 for **Minitrend GR** 8 for **eZtrend GR** and **DR Graphic**

- *MaxMin -Select by either Pens or Groups. Showing either the pen numbers or the Group name. Maximum 32 pens per group for **Multitrend GR**, 16 for **Minitrend GR**, 8 for **eZtrend GR** and **DR Graphic***
- *User Variables -Select from the User variable list*
- *Script timers - Select the Timers required from the list*
- *User Counters - Select this to display any User Counters already set up.*
- *Status - Select this to display the Status screen*
- *Totals - Select this to display the Totals screen*
- *Messages - Select this to display the Messages screen. Options to display All, Alarm, System, Diagnostics, Security or User messages*
- **Select By** - This gives you the option of selecting Pens or a pre-defined Group of pens that will be displayed on the screen. This will be the default if AMS2750 Process screen is selected in Template Type.
- **Showing (Pens)** - (Only available if Pens is selected in Select By). Select pens from the on screen selection to be displayed on this screen. Available pens will be in bold text on the selection screen and pens that are already selected will have a blue edge.
- **Group Name** - (only available when Group is selected in Select By). Select which group of pens is to be displayed on this screen. To assign a pen to a group, see [“Pens Menu” on page 84.](#)
- **Orientation** - (Not on the DPM screen). Set the orientation to Vertical or Horizontal for Scales and Charts.
- **Cycle Scales** - (active with chart and scale combination). If ticked, the recorder will cycle through each pen in the form of a scale or bar chart depending on which is selected for the Scale Indicator .
- **Scale Indicator** - (active with chart and scale combination). Select which indicator, either bar or pen pointers, will indicate on the scale.
- **Background** - Background colour can be set if no template is used. Select and choose from the Colour palette.

Add Screen

- To add a new screen just select Add Screen and configure as required.

Delete Screen

- To Delete a screen just select Delete Screen to produce a list of current screens. Select the screen to delete and it will be removed immediately.

When the configuration is complete select the Finish button to Commit, Discard or Commit Later. Select the Back button to return to the previous menu.

Settings

(Main Menu > Configure > Layout > Edit > Settings)

Use this menu to set up the layout settings for the screens.

- **Cycle Screens** - Tick this to cycle through each of the recorder's screens
- **Cycle List** - Select which screens you wish to be cycled including non-process screens
- **Cycle Interval** - Enter the amount of time, in seconds, that each of the cycle screens are displayed for. (range 5 to 3600 seconds)
- **Screen Hold** - If during cycling screens you wish to investigate a certain screen for a longer period than the cycle interval you can enter a time period here for the amount of time that screen will be displayed. (range 0 to 3600 seconds)
- **Alarm Screen** - Select which screen is to be displayed when any pen goes into an alarm state. Only changes colour if Mark on Chart is enabled in the "[Alarms Menu](#)" [on page 88](#)
- **Alarm Screen Name** - Only active if Alarm Screen is enabled
- **Replay Screen TO (TimeOut)** - If the recorder is in replay mode and there has not been any user activity for a defined amount of time then the replay screen will return to the process screen.
- **Replay TimeOut** - (only active if Replay Screen TO is enabled) Enter how long, in minutes, before the replay screen returns to a process screen. Defaults to 10 minutes.
- **Menu Bar TO** - When you select an item from the menu bar along the top of the process screen it will produce a sub-menu bar. This sub-menu bar can have a display time assigned to it before it automatically disappears and returns to the main menu bar. Enter here the amount of time before the menu bar is hidden.
For screens that have been created in the Screen Designer software and have been designed specifically without the menu bar being displayed. The menu bar at the top of the screen will appear on the recorder automatically but can be hidden so the full area of the screen can be displayed. Enter here the amount of time before the menu bar is hidden.
- **Hourly Stamps** - The Hourly stamps appear on the Trend Screen instead of the date and time stamps for chart speeds of 10mm/hr, 20mm/hr, 30mm/hr and 60mm/hr (if enabled). When the recorder screen is put into replay mode. As you zoom out the time stamps on the chart background change from minutes to hours.
- **Show Chart Start/Stop** - this will show or hide the Chart Start/Stop Message when the chart has been started or stopped.
- **Hot Btn 1** - HB1 to HB4 select Name to rename the Hot Button. Tick to enable the Hot Button appearing at the top right of active trend screens. Once enabled any corresponding event that has been setup will be triggered after clicking on the hot button. 4 Hot Buttons available for the **Multitrend GR and DR Graphic**, 2 Hot Buttons available for the **Minitrend GR**, 1 Hot Button is available for the **eZtrend GR**.

| 0001:Recorder #1 | | 03 Jan 06 08:53:32 | |
|------------------|---------------|--------------------|------|
| 14 | Screen | HB 4 | HB 3 |
| HB 2 | HB 1 | | |
| Pen 2 | Pen 3 | Pen 4 | |
| PV: 49.92 | PV: 49.92 | PV: 49.92 | |
| Max:49.92 | Max:49.92 | Max:49.92 | |
| Min:49.92 | Min:49.92 | Min:49.92 | |
| Pen 6 | Pen 7 | Pen 8 | |
| PV: 49.92 | PV: 49.92 | PV: 49.92 | |
| Max:49.92 | Max:49.92 | Max:49.92 | |
| Min:49.92 | Min:49.92 | Min:49.92 | |
| Pen 10 | Pen 11 | Pen 12 | |
| PV: 49.91 | PV: 49.91 | PV: 49.92 | |

Appearance

Chart background colour and graduations and the chart background colour when the recorder goes into an alarm state can all be changed. The same set of characteristics can be changed for a chart in Replay mode using the colour picker. The colour of the Time Stamp at the top of the chart and Marker (Mark on Chart) can also be changed.

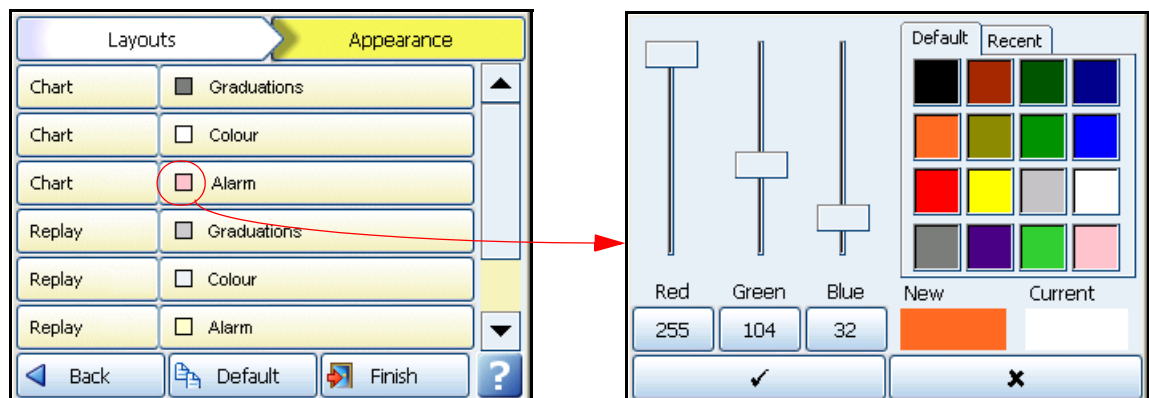

- **Chart/Graduations** - This will change the colour of the graduation lines on the chart
- **Chart/Colour** - This will change the colour of the background of the chart
- **Chart/Alarm** - This will change the colour of the background of the chart when it goes into an alarm state
- **Replay/Graduations** - This will change the colour of the graduation lines on the chart when the recorder screen is in Replay mode
- **Replay/Colour** - This will change the colour of the background of the Replay chart
- **Replay/Alarm** - This will change the colour of the Replay chart when it goes into an alarm state

- **Time Stamp** - This will change the colour of the time stamp/and date at the top of the screen
- **Marker Colour** - This will change the colour of any Mark on Chart displayed on the screen

The **Default** button will return all colours to their original factory settings.

The Colour Picker

On the right side is a selection of default colours which can be used as they are. When a colour is selected it will appear in the New box with the Current colour next to it. Use the sliders labelled Red, Green and Blue to vary the colour displayed in the New box. As you move the slider the colour shade number will change in the box below the slider.

If a specific colour is required, enter the colour number by selecting the box under the Red, Green and Blue sliders and the colour will be change accordingly in the New box.

When the desired shade has been chosen, select the tick box to confirm you choice. Each new colour will be saved and will appear in the Recent tab.

Save Layout

(Main Menu > Configure > Layout > Save)

Layouts can be saved to SD card, USB key removable storage media or to a Network Share folder (NAS). Plug in a removable storage media device and the corresponding button on the screen will become active, select the relevant media button.

Enter the file name required in the File name box. Maximum of 50 characters. File format is *.Jay*, click on the Save button.

For Network Share folder select the NAS button and the “Save Layout to NAS” dialog will open. Enter the Layout file name in “Filename” and click on Save.

The SD card and the front USB device port are found under the front flap on the recorder. There is another USB port at the rear of the recorder. The first USB device fitted will be USB1, therefore the second USB device fitted is USB2. SD card is available as a credit option for the **eZtrend GR**.



For Saving and Loading Layouts

NAS button will only be enabled if “Use Share path” is toggled on in “Admin Network” and NAS devices are enabled in [“Media Config” on page 137](#) and an warning “Access Denied for Media” will appear. If the Network Share folder is not available or incorrect then the following error will appear “Please check folder is shared and network admin settings are correct”.

Load Layout

(Main Menu > Configure > Layout > Load)

Layouts can be loaded from a SD card, USB key removable storage media or to a Network Share folder (NAS). Plug in a removable storage media device and the corresponding button on the screen will become active. Select the relevant media button to display the layout files available to load. Select the file and click on the Load button.

For Network Share folder select the NAS button and the “Load Layout from NAS” dialog will open. Select the Layout file required and click Load.

All screens loaded from another recorder, via SD card, USB, a Network Share folder (NAS) or Screen Designer will over-write the existing screens on the recorder.

The SD card and the front USB device port are found under the front flap on the recorder. There is another USB port at the rear of the recorder. The first USB device fitted will be USB1, therefore the second USB device fitted is USB2.

See [“Storage Media Format” on page 184](#) for formatting information of SD card cards and USB keys.

SD card is available as a credit option for the **eZtrend GR** recorder.

When loading layouts from Screen Designer see [“Loading a Layout into a Recorder” on page 239](#).

Passwords

(Main Menu > Configure > Passwords >)

The Password system manages the security within the recorder menu system. It allows restricted access within the recorder, providing password protection at different levels.

If your recorder has ESS (Extended Security System) enabled the password system cannot be disabled.

An Administrator should be nominated to have control of the password system

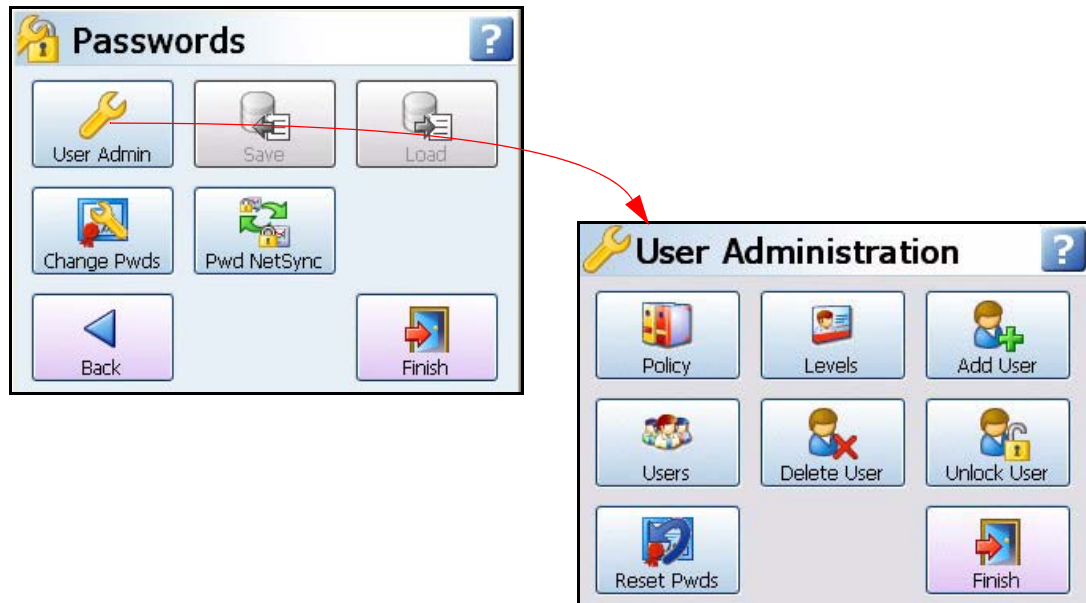

First Time Login

The "First Time Login" only relates to ESS (Extended Security System) purchased with the recorder.

Non ESS user

For users without ESS, once you enable the password you can add a user at administrator level and finish/apply/etc. Then go into the menu system and enter the login and it will give you a message that your password has expired and would you like to enter another, you click yes.

If the first user is not entered and changed to administrator (defaults to operator) and saved, you will be denied access as an operator because an operator level will not allow you to get back in the passwords.

The first time the system is used a default user name and password is available, the user name is "Admin" and will have no password, this is known as the "first time" user. Access to the first time user is removed once the password system has been configured. The first time user is reinstated if the password system is reset.

For recorders with Extended Security System (ESS), see ["First Time" Password System Setup](#) on page 208.

Administrator

This is the top level access to all menus. Only the Administrator has access to the password setup. The Administrator is responsible for adding users and assigning their levels of access throughout the recorder menu system. More than one Administrator can be set up.

User Administration

(Main Menu > Configure > Passwords > User Admin)

The Administrator can set up the recorder's password policies, permission levels of access in the menu system and can add, delete and unlock users and assign their permission levels. Passwords can be Reset from this screen.

The recorder will display a default setup that can be customised to suit. This is set out in "[Level Permissions](#)" on page 211.

NOTICE

When creating passwords, it is recommended to use a mix of capital letters, small letters, numbers and special characters to create a "strong" password

Policy

(Main Menu > Configure > Passwords > User Admin > Policy)

At the top of the Policy menu are four levels to be assigned, these are the permission levels that will allow access to specific areas of the recorder menu system. The names of these levels can be edited here.

- **Pwds Enable** = Tick to enable the password menu
- **Level 0 Name** = Administrator. Highest permission level
- **Level 1 Name** = Engineer. Second highest permission level
- **Level 2 Name** = Supervisor. Third highest permission level
- **Level 3 Name** = Technician. Fourth highest permission level
- **Level 4 Name** = Operator. Fifth highest permission level
- **Unrestrict** - allows the Administrator to de-restrict access to certain areas so menus will be available even without logging in.
- **Menu Timeout Enable** - Tick to activate the timeout facility to be enabled on the menus. (This is always enabled for ESS).
- **Menu Timeout** - Set a specific time period of inactivity in a password protected area before logging out. (20 to 3600 seconds)
- **Web Timeout Enable** - Tick to activate the timeout facility to be enabled on the web page. (This is always enabled for ESS).
- **Web Timeout** - Set a specific time period of inactivity in the web page before logging out. Enter the time in seconds. (20 to 3600 seconds)
- **Old Passwords** - Select how many previously used passwords are locked from use as a new password. (Max.12 previous passwords, 0 for disabled) Cannot be disabled for ESS recorders.

- **Username Max** - Set the maximum amount of characters that can be used for the User name login. (1 to 20 characters, 4 to 20 for ESS recorders)
- **Password Max** - Set the maximum amount of characters that can be used for the Password login. (1 to 20 characters, 6 to 20 for ESS recorders)
- **Username Min** - Set the minimum amount of characters that can be used for the User name login. (1 to 20 character and 0 will disable, 4 to 20 characters and no disable for ESS recorders)
- **Password Min** - Set the minimum amount of characters that can be used for the Password login. (1 to 20 characters, 0 will disable, 6 to 20 characters and no disable for ESS recorders)
- **Min Alpha** - Set the minimum amount of alpha characters to be used in the Password. (0 to 20 characters)
- **Min Symbol** - Set the minimum amount of symbol characters to be used in the Password. (0 to 20 characters)
- **Min Numeric** - Set the minimum amount of numeric characters to be used in the Password. (0 to 20 characters)
- **Pass Retries** - Set how many times the incorrect password can be entered before the user account is locked out. (1 to 10 retries, 0 will disable, 1 to 6 retries and no disable for ESS recorders)
- **Pass Expiry** - Set how many days before the current passwords will expire. (1 to 365 days and 0 will disable. For ESS recorders 1 to 180 days and no disable)
- **Expiry Warning** - Set how many days before the passwords expiry date that a warning notice will appear. (1 to 20 days and 0 will disable, no disable for ESS recorders)

When the configuration is complete select the Finish button to Commit. Select the Back button to return to the previous menu.

Levels

(Main Menu > Configure > Passwords > User Admin > Levels)

The Level permissions are the 4 user levels that have been set up and named in the Policy menu eg. Engineer, Supervisor, Technician and Operator.

Select each user level eg. Engineer, and setup the permission areas for that particular level of user. Each Permission Area will give the user access to selected menus in the recorder. The level permission has a set of default settings that are defined in [“Level Permissions” on page 211](#). Permission areas can be customised for each level if required, see [“Users” on page 167](#).

Add User

(Main Menu > Configure > Passwords > User Admin. > Add User)

The Administrator enters each new user name, then selects the new user and assigns their Level of permission. The Administrator can set up a new user but cannot assign a password. A dummy password is set and the new user is prompted to change the password when they first Log on.

The same user name cannot be used. User names must not contain numeric characters.

The Administrator can add more than one user at a time. They will not be added until the configuration has been Committed. When the configuration is complete select the Finish button to Commit.

When a new user is added a default password (“password”) is set. When a new user first logs on they are prompted to change the password. The new user is responsible for remembering their own password. The Administrator will not be able to access this information. But the Administrator is able to reset the password for any user.

Users

(Main Menu > Configure > Passwords > User Admin > Users)

This will list all the current users that have been entered into the password system and their access details. Select a user to produce the following:

- **User Name** - Displays the user name.
- **Level** - Select a permission level from the drop down list
- **Custom** - Activate this to allow customisation of the permission area access for this user only. The custom settings will reflect the original Level set when the user was first added.
- **Edit** - Allows customisation of the permission areas. The Administrator can re-assign the permission areas for individual users at any level.
- **Login Days** - Select the days on which this user can Login.

Delete User

(Main Menu > Configure > Passwords > User Admin > Delete User)

This will list all the current users that have been entered into the password system. The Administrator can delete users from a drop down list.

Note: Administrator cannot be deleted.

When the configuration is complete select the Finish button to Commit or Discard. Select the Back button to return to the previous menu.

Unlock User

(Main Menu > Configure > Passwords > User Admin > Unlock User)

This will list the current users that have been entered into the password system. The Administrator can unlock a user that has been timed-out (eg. password expiry) by selecting a user from a drop down list. Select the user and choose Re-enable Current or Reset to Default, that will set it back to the original setting.

Reset Passwords

(Main Menu > Configure > Passwords > User Admin > Reset Password)

This will produce a text box warning that if you reset the passwords all the current settings will be lost and the password system will return to the factory default setting. Select whether to Continue or Stop the reset procedure.

Ensure that passwords entered by customers are mix of capital letters, small letters, numbers and special characters

Change Passwords

(Main Menu > Configure > Passwords > Change Passwords)

The Change Password function can be accessed by all users. Select Change Password and enter your user name and old password, you will then be prompted to enter your new password twice to confirm.

Password Network Synchronisation (Password NetSync)

(Main Menu > Configure > Passwords > Pwd NetSync)

Passwords can be synchronised over the network, a recorder can be designated as a master of a password group and other recorders can be added to that password group as slaves. The master will ensure all passwords and password policies are synchronised with all recorders in its password group. Limited changes can be made on slave recorders, eg. the user may change passwords and this will be propagated to all the other devices in the password group.

Password Net Sync Rules

Before starting read through this check list:

1. To enable a recorder to use Password Net Sync the firmware option needs to be activated in the Credit system, see [“Section 7: Firmware Options” on page 241](#).
2. Only recorders with the Password Net Sync option enabled in the Firmware options will be available to the designated Master or Slave and be accessible in the password group.
3. Ensure that the networked recorders to be included in the password groups are on the same IP subrange of A.B.C.<x>, such that A.B.C is fixed and only <x> is variable.
4. Ensure that all recorders to be included in the same password group are configured to be in the same Set with the same Start Port and have Peer Services enabled. This can be checked from the *Menu > Configure > Setup > Edit > Comms > Services > Peers* menu. Unless the network administrator states otherwise, there is no reason to change the default Start Port value of 8955. For more information see [“Peers” on page 110](#)
5. Ensure that passwords are enabled from *Menu > Configure > Passwords > User Admin > Policy* on all of the recorders to be included in a password group.
6. Recorders in the same Master/Slave password group must have the same revision of firmware.
7. Recorders set up with ESS (Extended Security System) and non - ESS recorders cannot be mixed in the same password group.
8. Choose a recorder to be the Master of the password group and go to the “Pwd Net-Sync” dialog on that recorder from the *Menu->Configure->Passwords* menu. Set the Type field to Master and the use the Associated Slaves field to pick from a list of available recorders in order to make up the password group membership.
9. If a recorder is a part of a password group and the network becomes disconnected then the recorder will notify you of the available options concerning its associated password group. This will occur if you have to update a password or if you have the Alert function set up to provide an Alert message that says the network cable is unplugged or if you do a rescan of the system.
10. To remove a recorder from a password group set the recorder back to a stand alone device and deactivate the Password Net Sync option in the Firmware Credits menu. This will cause the recorder to reset. This recorder will no longer be available for use in a password group. But the password system and policies will still be active using the last group password.
11. If a Master is removed from a password group a new master can be assigned or all the recorders can be returned to Stand alone recorders and the password group is dissolved.
12. As soon as confirmation is made in the Password Net Sync screen (using the tick) then the information will be passed on to all recorders in that password group.

13. When a password is changed or recorders are added or removed from a password group, a password synchronisation occurs automatically.
14. A password group can be set up from the Master recorder without assigning all the slaves required. You may not know the names of the recorders for the password group at that time. When the password group is established each recorder you want to add to the password group can be visited and added as a slave to the password group.
15. A login failure on any recorder in a password group, after 3 tries (or whatever is set up in the Master), will lock that user from all recorders in that password group. Contact your Password "Administrator" to reset the password from the master recorder only.
16. Slave recorders have limited access to the Password Net Sync system; a user password can be changed and sent out to update all the other recorders. Slaves can also leave a group or promote themselves to Master. All the password (Admin) configuration must be executed through the Master recorder.
17. Maximum slaves in any one password group are 31.
18. Maximum size of any peer to peers network is 32 recorders.
19. Stand alone recorders that already contain a password configuration will have their password configuration overwritten when they become part of a password group.
20. A new Master can be elected from any Slave recorder in the password group by going to the Type field in the "Pwd NetSync" dialog that is available from the Menu->Configure->Passwords menu and selecting Master. Any existing Master will automatically be relegated to a Slave, and if the current password group Master was down at the time then it will be relegated to be a Slave the next time it comes online at start up.

Notes

1. Password NetSync is heavily dependent on a reliable network. If the system seems to be suffering from apparently poor network connectivity then try splitting the password group up into multiple password groups, with each group on a separate Set. Please see the Manual for more details on Sets.
2. Running Password NetSync without the Master of the password group powered-up and connected to the network is an error condition. Please rectify this situation as soon as possible as Password NetSync cannot be expected to function properly without a password group Master being present.

NOTICE

The Password NetSync function in the **GR-Series** recorders uses a Peer to Peer communications protocol to synchronize passwords between the various recorders within the Network Synchronization Group. While these systems have been rigorously tested with various network topologies, **Honeywell** cannot guarantee that it will work with every combination of network switches, hubs and other Ethernet network communications equipment and settings. Users of the Password NetSync function who experience issues with the recorders not being found or losing contact between various Password Slaves and the Password Master will need to troubleshoot their own network to insure proper operation of the Password NetSync function.

Figure 4.1 Example of Peer Network consisting of 2 Password Groups

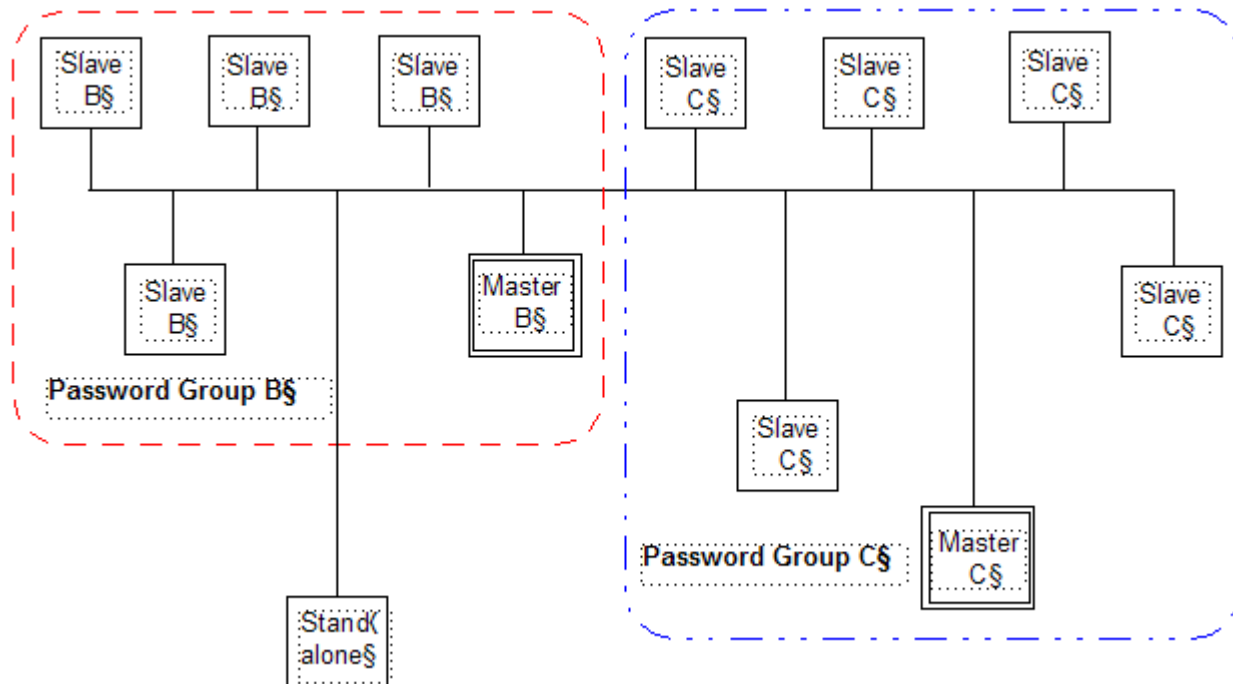

Password Net Sync Configuration

- **Type** - To set up the Master recorder for the password group first select Master to make this recorder a slave device and select Slave.
- **Password Group** - For a Master recorder enter the password group name using the on-screen keypad or keyboard. For a Slave recorder select a password group from the list to join this recorder to an existing group.
- **Associated Slaves** - For Master recorders only. Touch the screen to select from the available recorders shown in red. Recorders that are enabled for password net sync, and that already belong to this password group, will be displayed in green. Recorders not available because they are a part of another group or do not have the firmware option enabled will not be displayed.

Select the back button and if all is correct confirm using the tick button. This will have immediate effect. The update could take up to 2 minutes.

Figure 4.2 Password Network Synchronisation setup

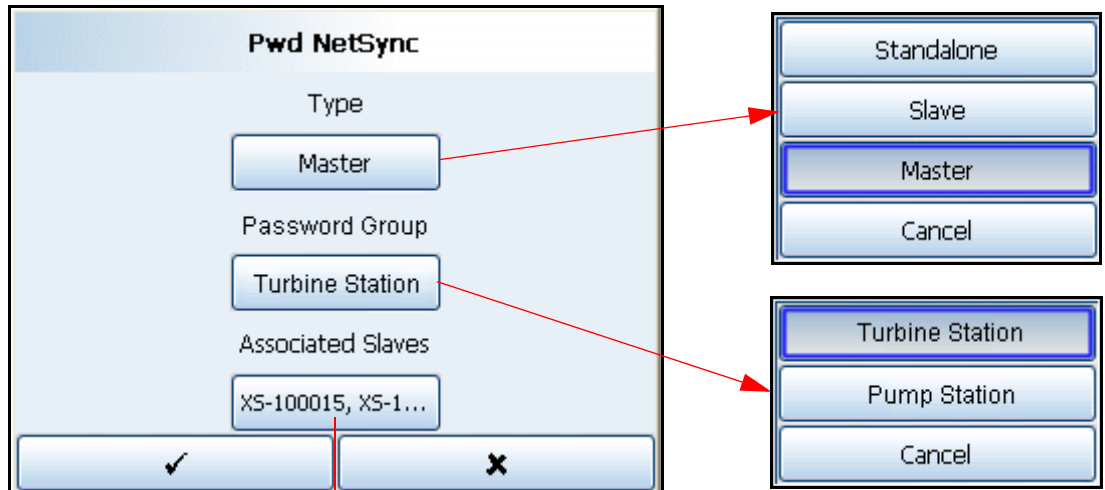

If Master is selected a keypad will be displayed to enter the new password group name.

If Slave is selected a list of existing password groups will be displayed



This screen is available for a Master recorder so associated slaves can be added to its password group. Only recorders with Pwd NetSync enabled will be displayed here.

Recorders in red do not belong to any password group and are available to be added to a group.

Touch the screen to select from the available recorders shown in red. Recorders that are enabled for password net sync, and that already belong to this password group, will be displayed in green.

Pwd Net Sync Messages

Certain selections may cause the recorder to display specific messages when an entry or action has been executed. Here are some examples of some messages that may appear during Pwd Net Sync setup.

Examples of messages that may appear during Password NetSync set up

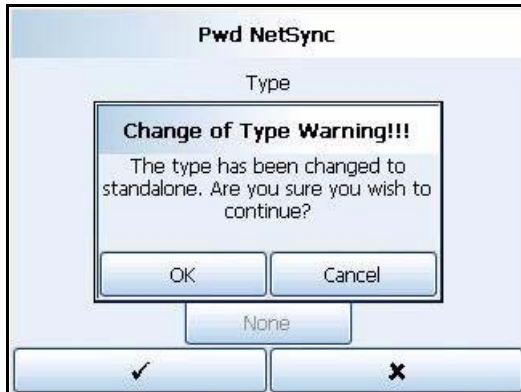

This warns you that you are changing the recorder Type in the Group; Slave, Master or Stand Alone



This may occur if someone is accessing the same group of recorders.



This message will appear when the recorder is scanning the network



All recorders in this group have had their passwords synchronised successfully

Settings

(Main Menu > Configure > Settings >)

Set Time

Set up the Time and Date for the recorder's real-time clock. Check that the correct Time Zone is set before setting the clock. [See "Localisation" on page 136](#)

Date

Select each button to set the day, month and year. This will automatically update and be displayed on the Menu bar at the top of the process screen.

Time (HH:MM:SS)

Select each button to set the hours, minutes and seconds. The hours selection provides a list and the minutes and seconds require a numeric entry. This will automatically update and be displayed on the Menu bar at the top of the process screen. The recorder uses a 24 hour clock.

Tick to confirm the setup changes and return to the Settings menu. Select the cross to ignore any changes and return to the Settings menu.

From the Settings menu select the Finish button to commit the changes or select the Back button to return to the previous menu.

Set Volume

Set the volume here for the sound effects. Use the slider to increase and decrease the volume. Press the arrow button to the right of the slider to test the volume.

Update Sounds

The user can pick from a list of 20 different sounds these can be configured to play a single time or repeat continuously. To upgrade sounds the user must have a compatible sound file format of .wav; the .wav file needs to be renamed to the internal format which is as follows.

S<n> - <name>.wav

Where <n> is number 1 to 20 and <name> is a short name to describe the sound, this file name will be shown in the pick lists. **Eg. S1-Alert.wav.** So a user could replace the default sound 1 which is "S1-Two Tone Slow.wav" with "S1-User Sound.wav" and this is what they will then see in their list.

To update the sounds a prompt will be displayed and the system will request the correctly named files be available on external media in the recorder, once confirmed the system will scan the media for correctly named .wav files and will replace the internal files with the new ones. NB the .wav files can be up to 100KB in size.

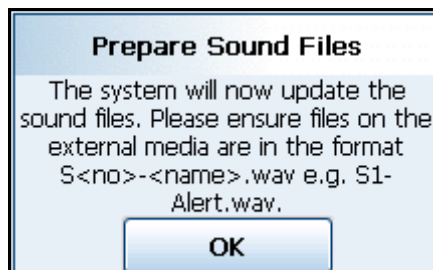

AMS2750

(Main Menu > Configure > Settings >AMS2750)

Disable Thermocouple Adjustment Factor

One method of checking the recorder calibration is to connect a temperature calibrator (TC simulator) and inject known values. These can be read on a standard DPM summary screen, and checked against requirements. So for example if 800 degrees is injected, customers would expect to see 800 degrees on all the inputs (+/- allowable tolerance).

If the TC Cal. Adjustment factors have already been entered, those TC offsets will be being applied, and that changes the displayed temperature. Whilst not technically incorrect, it has lead to user confusion so a temporary means of switching the TC cal adjustment factors “off” has been added.

To access this “switch” navigate to the Configure menu and select the Settings button. Once selected an AMS2750 button is shown, and selecting this will let the user switch “on” or “off” the TC calibration adjustment. This button is only be displayed if the AMS2750 Survey mode is enabled.

In order to ensure that the values are not omitted from an actual survey run, the instrument automatically “switches on” these TC Cal. Adjustment values if they have been mistakenly left off.

In addition a User Message will entered into the message list when this switch is turned “Off” or “On”, which will enable users and auditors to demonstrate a traceable line of action if required

Alarms Menu

(Main Menu > Alarms >)

Acknowledge and Configure Alarms by categories.



Acknowledge Alarm

(Main Menu > Alarms > Acknowledge Alarm)

User acknowledgment of alarms can be performed at this menu, only Latched alarms can be acknowledged. Normal alarms cannot be acknowledged.

When a Latched alarm is set up in the Pen, Alarms menu and a latched relay is configured, it will maintain its active state until the alarm has been acknowledged.

A latched alarm will continue to flash, if an alarm marker is displayed, until it is acknowledged and it is out of alarm state. [See "Alarm Markers" on page 236](#) for flash colour identification.

Ack Alarm

- **All** - Select this button to acknowledge all active latched alarms.
- **By Group** - Select this button to acknowledge latched alarms in a group of pens. Pen groups can be set up in the Pens menu
- **By Pen** - Select this option to acknowledge latched alarms for individual pens.

Configure

(Main Menu > Alarms > Configure)

This is a short-cut to change alarm levels, this will display all available pens with alarms set up. To change the configuration, select the desired pen, this will display the alarm details. Select the Edit button to change the alarm level. If the Edit button is greyed-out go to the Pens > Alarms menu and select the relevant alarm number, then activate Allow Change.

View

(Main Menu > Alarms > View)

This will display all available Pens with alarms set up. To view the configuration, select the desired pen, this will display the alarm details.

Screen Menu

(Main Menu > Screen)

The Screen Menu contains an Edit button to configure screen settings for standard screens or Pen/Channel Mapping for custom screens. The Replay screen is used to view previous data and has a List button to change the screen currently being displayed. There is also a Clean Screen facility, and should you require to re-Calibrate your touch screen, there is a Calibrate function and a Touch Test feature.



Edit, Screen Properties

(Main Menu > Screen > Edit)

For **Standard Screens** the menus are the same as [“Edit Layout” on page 157](#)

Edit Toolbar

For **Custom Screens** (Not available on the **eZtrend GR**).

Select the Edit button whilst displaying a Custom Screen (Layout from Screen Designer) will take you to your current process screen and displays the Edit toolbar at the top of the screen.



In Edit mode you can select items on the screen and assign channel/pen information to them and move and resize certain items on the screen.

Expert/Non Expert button

All process screen are made up from items called Widgets and Objects. A widget is a container for one or many objects. Objects display data in graphical forms such as Bar, Scale, DPM, Text. The Expert button toggles to Non-Expert mode, displayed with a red cross. Expert mode allows objects to be selected and Non-Expert allows widgets to be selected.

To select a widget the Expert button must be disabled; displaying a red cross. A widget has green resize handles that appear when it is selected. To select an object the Expert button must be active, with no red cross showing. Objects have blue resize handles when selected. When a widget or object is selected it can be moved and resized.

Figure 4.3 Expert and Non-Expert selection

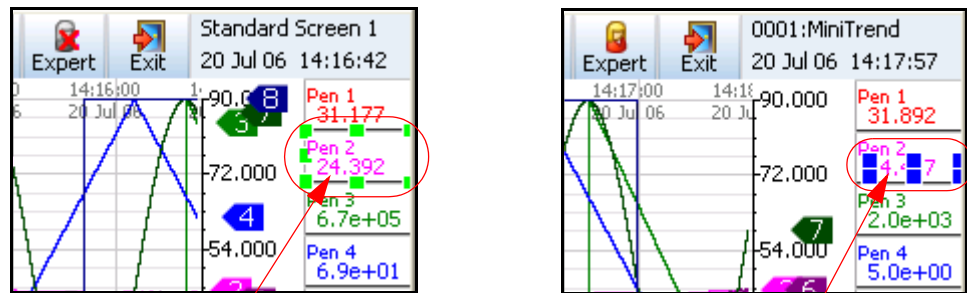

Non Expert mode selects the Widget with green resize handles (the whole DPM)

Expert mode selects the Object with blue resize handles (part of the DPM)

Map Button

Map button

The Map button, in the Screen Menu bar, enables the user to associated channels to pens so the pen being displayed on the object or widget will display the actual signal on that channel.

Channel Mapping Widgets

Channel configuration can be done per widget or per object. Configure the widget if all the objects on the widget are to be mapped to the same channel. Select the widget and go to the "Map" in the Screen menu toolbar. Widgets have green grab handles around the edge.

Pen and or channel information will appear for each object within the widget. Each object in the widget can be assigned to the same or different Pen.

For example a DPM menu will display the pen currently being used and a set of channel information associated to the text, digital and alarm marker objects within the DPM widget. Select any of the objects in the channel menu to produce the setup screen.

Channel Mapping Setup screen

In the Channel Mapping Setup screen select where the data is from:

- **Data from:** *Pen*; set what the object is going to be showing: Current Value, Minimum value, Maximum value, Average pen reading or Total pen reading.
- **Data from:** *Alarm for Pen*; set the alarm number
- **Data from:** *Input Channel*; set the channel number and what the object is going to be showing: Analogue, Digital, Hi Pulse or Low Pulse

Select the pen number required. On a widget you can select the **Parent**, this will assign all the objects in the selected widget to the same pen. Select objects individually on the screen to assign different pens to each object within the widget.

- **Number:** of the Pen, Alarm for Pen or Input Channel

“Showing” is what is displayed on the screen. The selections will change depending on what is selected in Data From.

- **Showing:** For Pen - Current Value, Minimum, Maximum, Average or Total value.
- **Showing:** For Alarm for Pen - List of available Alarms
- **Showing:** For Input Channel - Analogue, Digital, Hi Pulse or Low Pulse

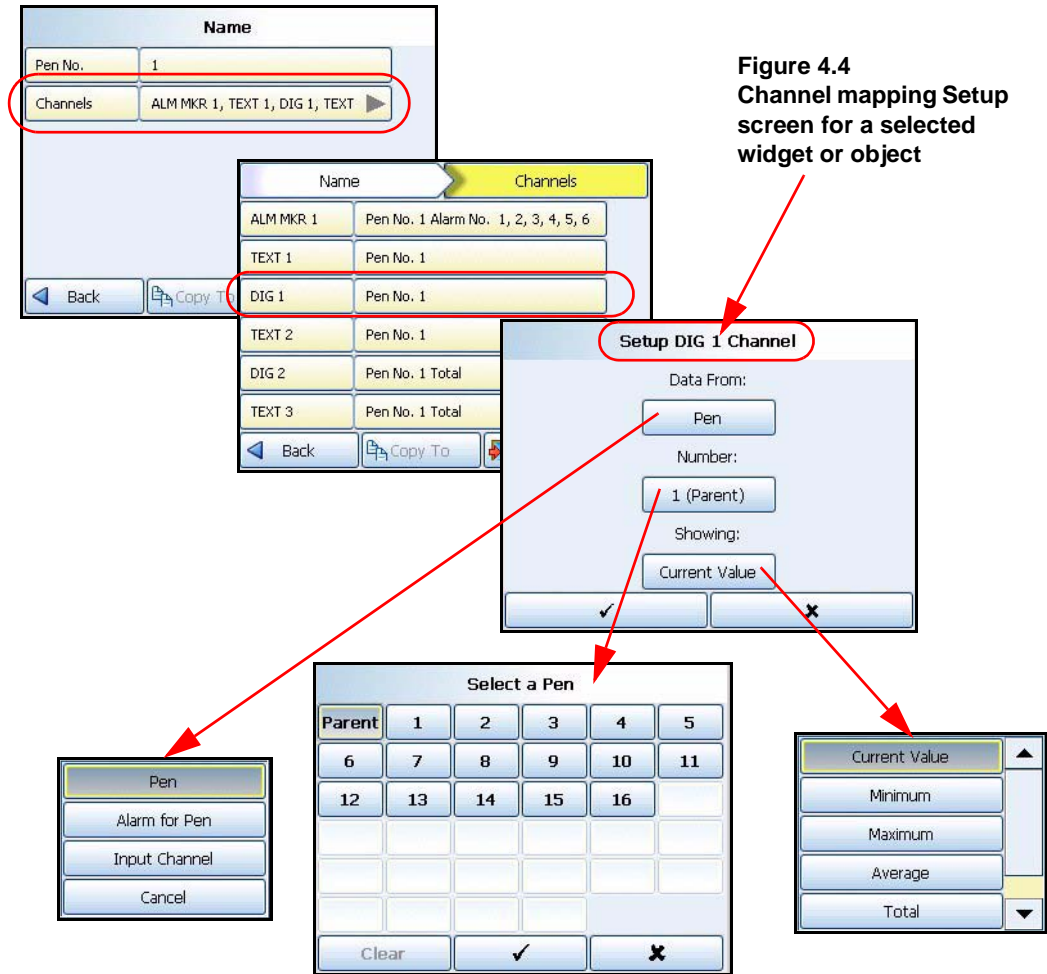

Figure 4.4
Channel mapping Setup screen for a selected widget or object

Channel Mapping Objects

To select an object activate the Expert button on the Screen menu bar. Objects have blue grab handles around the edge.

Select “Map” from the Screen bar to display the Setup information as described in [“Channel Mapping Setup screen” on page 177](#).

If the object is an Alarm Marker the data will always be from “Alarm for Pen”. Select the Pen number and the alarm number to be shown. Pen Pointers just need to be mapped to a Pen.

Parent Pens

This does not apply to charts as charts normally have more than one pen displayed. The parent channel is the initial channel to be configured on a widget. All objects added to a widget (except charts and pen pointers) automatically default to using the parent channel. The parent itself allows the user to quickly make all of their objects update to use the pen number indicated by the parent.

Replay

(Main Menu > Screen > Replay)

The Replay button takes you to the process screen in replay mode. The Replay screen consists of a chart and DPMs. The chart is vertical or horizontal depending on the orientation of the screen you have come from. The replay screen has DPMs that display max/min readings for each pen, these values are taken from where the cursor is positioned on the screen.

If any Hot Buttons have been configured to “Enter Replay Screen”, then when the equivalent Hot Button is selected (eg.HB1), in a Process screen, the Replay screen will be started. This does not apply to Non-Process screens. The Hot buttons will appear in the top right of the screen but will not activate on a non-process screen.

The replay screen has many features and functions so go to [“Replay” on page 228](#).

Screen List

(Main Menu > Screen > Screen List)

The Screen button produces a list of all available screens. Select to make this the current screen active on the recorder.

To add a new screen, go to Add Screen in: *Main Menu > Configure > Layout > “Edit Layout” on page 157*

Clean Screen

(Main Menu > Screen > Clean Screen)

The Clean Screen function disables the touch screen for 30 seconds so that the screen can be cleaned. A dialog box will appear informing you “You have 30 seconds to clean the screen. Press escape if you wish to close this dialog early”. The escape key option would only be available if a USB keyboard was plugged in. The box will also display a time bar to show the 30 seconds of time lapsing. [See “Cleaning Instructions” on page 301](#).

Calibrate

(Main Menu > Screen > Calibrate)

Your touch screen on the recorder is calibrated before leaving the factory. If when you use the recorder the screen does not match where you are touching it then calibration will be required. Select the Calibrate button and follow the on-screen instructions to calibrate the touch screen.

Touch Test

(Main Menu > Screen > Touch Test)

Use the Touch test feature to see if your touch screen is calibrated correctly. Select this button and touch the screen using the stylus. If the centre of the cursor follows the stylus around the screen then the touch screen is calibrated correctly. If the centre of the cursor is not where the stylus is touching the screen then go to the Calibrate button and recalibrate the screen.

Batch Setup/Batch Groups

(Main Menu > Batch)

Batch is a firmware option which can be activated from [“Credits” on page 131](#).

The Batch function allows the user to segment portions of data for further analysis. Batch mode has changed to allow for concurrent batches, where each batch is associated with a group, so all pens within Group 1 will belong to the batch that is controlled by Group 1.

Setting up a batch requires information to identify where the batch starts and stops. Batch data can also be paused, for viewing, and resumed. A batch can be aborted at any time, if so this will not register as a batch; a batch is only complete when it has been stopped.

Screens can now be set to display groups, in this mode only messages associated with that group (i.e. pens within that group, or batch messages for that group) will be shown on the chart.

If the groups in Batch Control are greyed out you need to go to the Pens menu and assign individual pens to a group. See [“Pens Menu” on page 84](#).

Up to 6 batches can be run concurrently. To start a batch enter information in all the required screens that have previously set up in the [“Batch Menu” on page 138](#). There are two options: The **Single Screen Batch** allows you to view and enter all the batch details on a single screen. If this is not selected the **Batch Wizard** will enable separate screens to enter the same information.

Select a Group #: (With Single Screen Batch enabled this information can be entered on one screen, if not the Batch Wizard will provide separate screens, see [Figure 4.5 on page 181](#) and [Figure 4.6 on page 181](#))

- **Batch Name** - Name to Identify the batch (up to 19 characters)
- **User ID** - Identification of user starting the batch. If Passwords are active on the recorder then the User ID page will be skipped for user entry and will be automatically entered. (up to 19 characters)
- **Lot.No** - Starts at 1 and increments by 1 and is user configurable
- **Desc** - Enter a description of what the batch is (up to 17 characters)
- **Comment** - Add any further comments

Lot.No, Desc and **Comment** are the default field names. The Description and Comment field names can be changed in [“General Batch Properties” on page 138](#). The Lot number is unique for each batch on a recorder and can be modified by the User. The Lot number can be entered by the user and starts at 1 and increments by 1 or can be selected from a predefined list. This is irrespective of whether the user is using Batch Wizard or Single Screen Batch to enter the batch details

If Allow Direct Access has been setup in the [“Batch Menu” on page 138](#) then a Barcode Reader can be used to make entries for all the items listed in this menu. See [“Barcodes for Batch” on page 183](#).

Note: For batch mode state and count in Maths scripts, see [“Maths Variable and Function Tables” on page 322](#). For batch mode state and count in embedded variables, see [“Embedded examples” on page 120](#).

Figure 4.5 Batch Setup screens using Batch Wizard

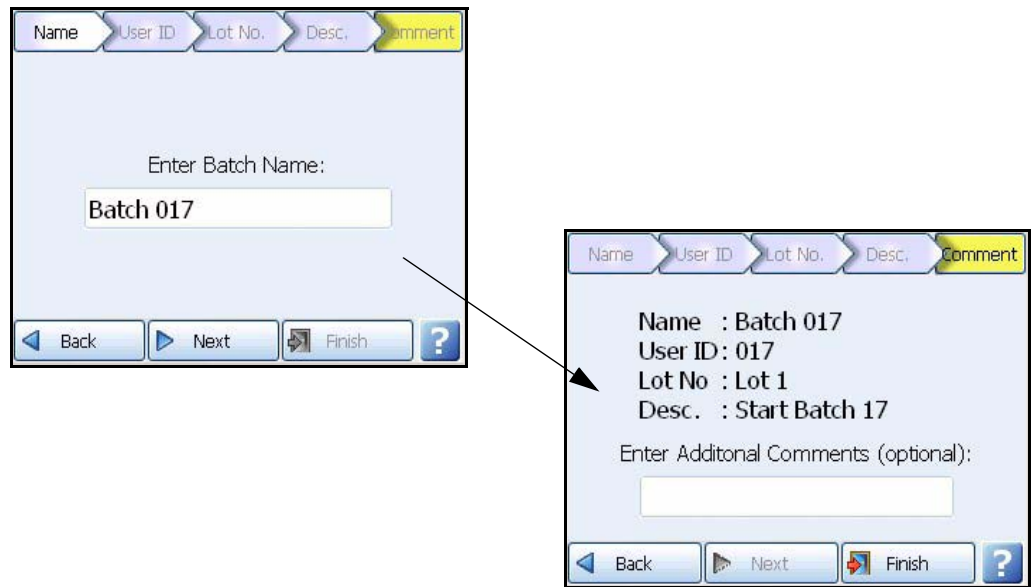
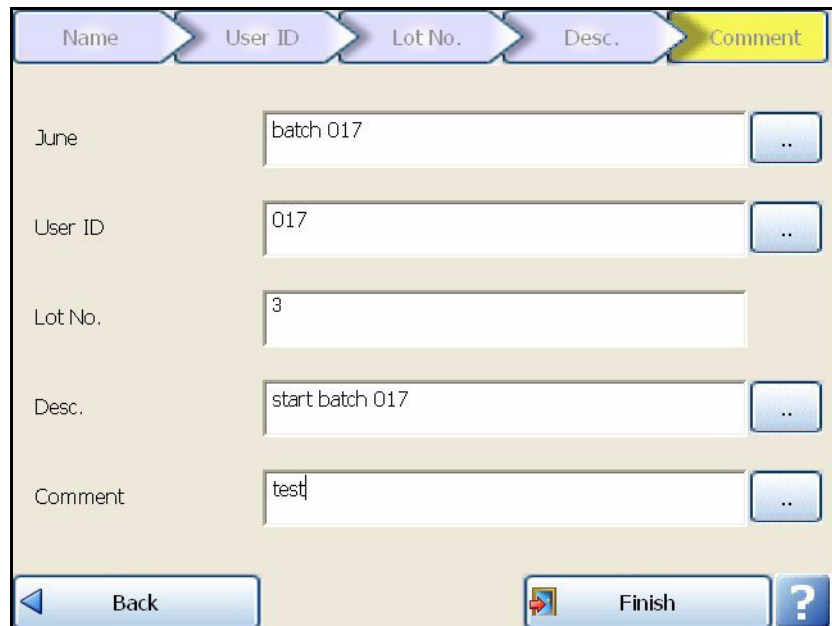

Figure 4.6 Batch Setup screens using Single Screen Batch



Press the Finish button if all the Batch details are correct and you wish to start the batch immediately. Use the Back button to return to the Batch setup and not start the batch.



When a Batch is in progress the icon changes on the batch screens that are running a batch group.

Start Batch Mark on Chart

Batch Mark on Chart

A Batch marker will be placed on all process screens that have a chart displayed.

The next time you press the Batch button the screen will have changed to give you the Batch Controls. The batch control buttons enable the user to Stop, Pause (Resume), Abort or add a Comment to the current batch that has been started.

A Batch is complete when it has been stopped. When a batch is stopped //E appears as a mark on chart on the screen. If the batch is aborted it is not a complete batch and will be marked on the chart with an //A to show it has been aborted.

If the recorder is not logging, starting a batch will automatically start the logging. However stopping the batch will not stop the logging.

If a batch is Paused //P will appear as a mark on chart and the Pause button on the Batch Control menu is replaced with a Resume button. When Resume is selected the screen will be marked with //R.

Figure 4.7 Batch Control screen and Messages screen

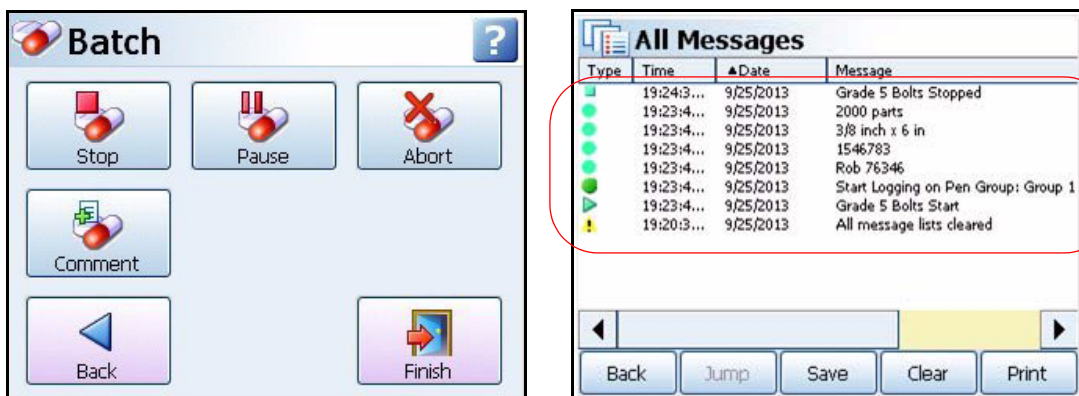

When the batch is stopped the Batch Control screen reverts back to the Batch Setup screen so the user can start a new batch. [“Batch Setup screens using Batch Wizard” on page 181.](#)

As well as a Mark on Chart for every command applied to the batch you can check the Messages screen for details of the batch activity.

Batch Commands

- //S = Start Batch
- //E = End or Stop Batch, this will complete the batch run
- //P = Pause the batch in progress
- //R = Resume batch. Only available when a batch has been paused
- //A = Abort batch. If the batch is aborted it is incomplete and the batch will be cancelled
- //I = User ID. Displays the user entered ID or User ID entered automatically by the Password function.
- //D = Description. User entered description of the batch in progress
- //L = Lot No. User entered Lot number for the batch in progress
- //C = Comment. Extra comment field of additional information for the batch in progress

Barcodes for Batch

Batch markers can be created using independent barcode software. The barcodes can then be read using a barcode wand or reader. Any type of Batch marker can be encoded into a barcode using the same control characters used to build up a batch marker.



This example shows a barcode encoded to start a batch:

//S = Start Batch

216 = Batch Name

//I = User ID is Fred

- A barcode with up to 25 characters (including spaces) can be read into the recorder using a USB ASCII barcode reader.

Recording Menu

(Main Menu > Recording)

This will display the current recording status of the recorder and allow recording control.

Recording Methodology

The recorder uses a new and powerful method for recording. Data is acquired, at pen specific rates, processed and stored in the large on-board Flash memory. This memory operates in a cycle mode such that the oldest data is over-written by the newest.

When data is exported from the recorder this does not delete that data from the recorder but retains it for further or future downloads. With this method the user can export multiple copies of the same encoded data, giving extreme security.



Storage Media Format

New SD cards and USB storage keys are pre-formatted for use in the recorder and PC. If you have a used SD card or USB key we recommend you erase it. Formatting of SD cards and USB keys can be done through your PC. The formatting types accepted by the recorder are FAT, FAT16, TFAT and FAT32. SD card is available as a credit option for the **eZtrend GR**.

Start / Stop Recording

The Recording screen will allow the user to manually Start and Stop recording. Select either the start or stop buttons to activate the function for All pens, a Group of pens (if a group is defined) or By Pen to identify an individual pen(s).

- **Recording:** Displays the current pen recording status and the number of pens currently recording.
- **Export Required In:** "XXd:XXh:XXm:XXs". This is the amount of days, hours, minutes and seconds left until the internal memory buffer starts to be over-written. Exporting does not remove the data from the recorder but when the internal memory buffer is full the latest data will start to over-write the oldest data. Available as a Maths expression, giving the hours until recycling starts, see "[Maths Variable and Function Tables](#)" on page 322.

- **Schedule:** Displays the frequency of a scheduled export (only if a scheduled export has been set up, see [“Edit Recording” on page 148](#)).
- **Media Full In:** Displays how long before the external media, selected for the scheduled export, is full.
- **FTP Export required:** “XXd:XXh:XXm:XXs”- This is the amount of days, hours, minutes and seconds of safe recording time available. An FTP export must be completed before the FTP buffer is full and the latest data will start to over-write the oldest data. Available as a Maths expression, giving the hours until recycling starts, see [“Maths Variable and Function Tables” on page 322](#).
- **Pre-Trigger Status** - This will show if the pre-trigger system is active along with its current state. The dialog automatically refreshes periodically.

Export Now

Export Now will transfer data from the internal memory to the external media such as SD cards, USB key or Network Share (NAS). Exporting does not remove the data from the recorder but when the internal memory buffer is full the latest data will start to over-write the oldest data.

The Network Share option (NAS) can be used for loading and saving of layout (.lay) and/or setup files (.set), saving (exporting) reports, any messages (Diagnostic, system etc), loading sound files from this network share to recorder. This can also be used to print to file and this file can be saved to this network shared folder.

The use of the network folder for Scheduled export is not recommended since network connectivity and network problems could result in the risk of missing data due to the Scheduled export not being performed at the scheduled time and the folder. It is advisable to use other media (USB, SD) for scheduled export.

Select the Export Now button to go to a sub-menu of available external storage devices.

Buttons become active when a device is fitted. Once fitted the size of the device memory and the amount of available space is displayed.

Select the desired device to export to and this will display two options New and All. The All function will export all the data in the recorder’s memory to the external device port. The New function will just export any new data since the last export was made to this port. If the scheduled export is enabled for a particular drive, then only the New option is selectable, not the All option.

If an Export Now is requested within 5 seconds of a Scheduled export being activated, the manual export will not occur.

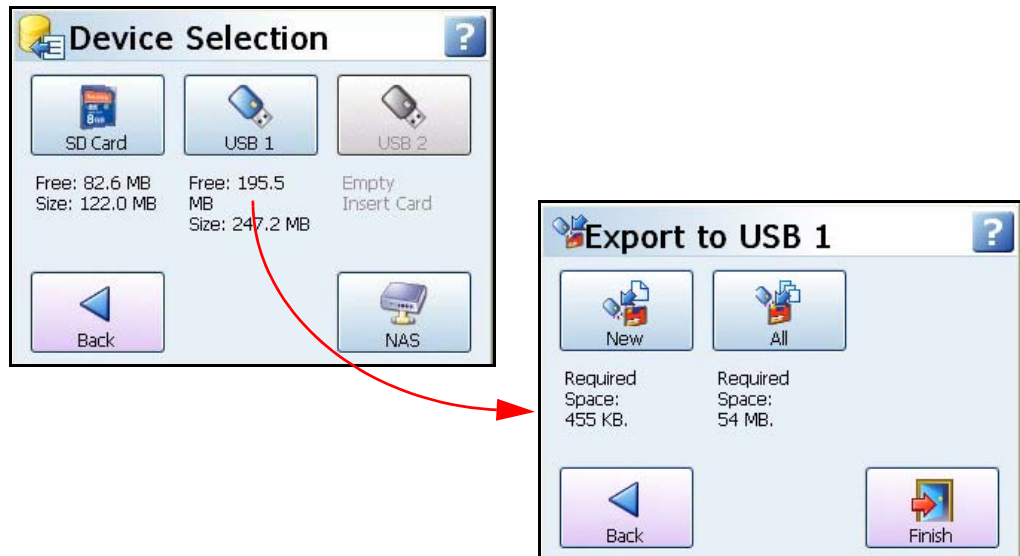

Device Selection

If the Device Selection buttons are greyed-out you will need to insert a SD card or USB key into the port or select Network Share folder (NAS). After a few seconds the button becomes active. SD card is available as a credit option for the **eZtrend GR**.

USB1 is the first USB device to be fitted and USB2 is the second one fitted, front or rear of the recorder. If the recorder is powered off and on again the USB keys will have to be refitted in order to know which is 1 and which is 2.

Export “busy” light

When data is about to be exported to a device the transfer busy light starts flashing. The flashing LED is a warning that the recorder is about to export to media. **DO NOT** remove the media whilst the LED is flashing. After a few seconds the flashing LED goes to “Full On” LED. Whilst the LED is fully on data is being written to the media. **DO NOT** remove the media whilst the LED is on. When the transfer is complete, the LED goes off and the media may now be removed.

Messages Menu

(Main Menu > Messages)

The messages screen will display message from many different areas. Specific types of messages have been put into categories or All messages can be viewed. The number of new messages to view are displayed on each button as a number in brackets after the label.



Message Types

- **All** - Select this to view a list of All types of messages. The messages screen will hold the latest 200 messages.
- **Alarms** - This is a list of active alarms that have occurred. The screen will display the Type of alarm, the Time and Date that the activity occurred and Message details of the activity.
- **System** - This will list a history of system messages. The screen will display the Type of messages and warnings and errors that have been generated by the unit. The screen will also display the Time and Date that the activity occurred and the Message details.
- **Diagnostics** - Examine a complete list of the recorder's functionality and processes since it was last powered up. The screen will display Type of message, Time and Date that the activity occurred and the Message details.
- **Security** - Audit trail of entries made to secure areas such as Password setup, including, Log on, Log off, what area has been accessed, time/date and the user name.
- **Users** - These are messages that have been entered by the user by entering a Mark on Chart. The screen will display the Type of message, Time and Date that the activity occurred and the Message details.

Printing Screens

All the Messages screens have a Print button, to execute this, the printer must first be configured in ["Network Admin" on page 98](#) and in the ["Printer Menu" on page 141](#). For details on suitable printer types see ["Print Support \(USB 2.0\)" on page 44](#).

The Printer function is a firmware option that is selectable from the Factory menu > ["Credits" on page 131](#).

Saving Screens

All Message screens can be saved as portable .rtf files onto removable media. These can be transferred to another location and kept for records or sent via email for troubleshooting and maintenance issues.

Message List

All messages will conform to the following format: Type, Time, Date and Format.

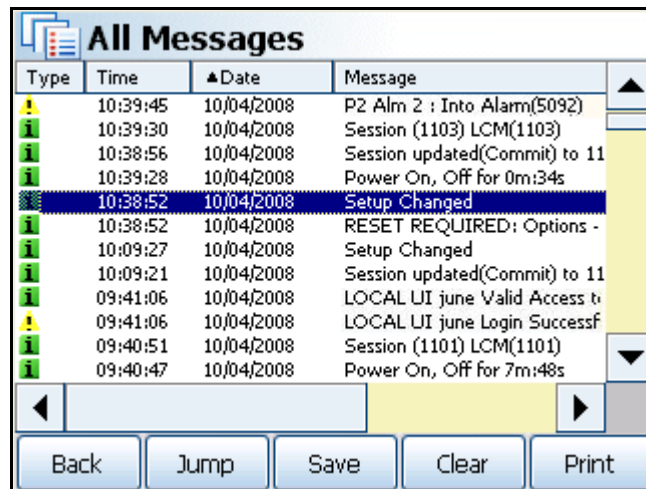

| Type | Time | Date | Message |
|------|----------|------------|-------------------------------|
| ! | 10:39:45 | 10/04/2008 | P2 Alm 2 : Into Alarm(5092) |
| i | 10:39:30 | 10/04/2008 | Session (1103) LCM(1103) |
| i | 10:38:56 | 10/04/2008 | Session updated(Commit) to 11 |
| i | 10:39:28 | 10/04/2008 | Power On, Off for 0m:34s |
| i | 10:38:52 | 10/04/2008 | Setup Changed |
| i | 10:38:52 | 10/04/2008 | RESET REQUIRED: Options - |
| i | 10:09:27 | 10/04/2008 | Setup Changed |
| i | 10:09:21 | 10/04/2008 | Session updated(Commit) to 11 |
| i | 09:41:06 | 10/04/2008 | LOCAL UI june Valid Access to |
| ! | 09:41:06 | 10/04/2008 | LOCAL UI june Login Successf |
| i | 09:40:51 | 10/04/2008 | Session (1101) LCM(1101) |
| i | 09:40:47 | 10/04/2008 | Power On, Off for 7m:48s |

The messages screen will hold the latest 200 messages.

Message button bar



















The message button bar runs along the bottom of all messages screens. The button are:

- **Back** - Takes you back to the main Messages screen.
- **Jump** - Select an item in any of the message lists and press the Jump button. This will take you to the exact time of the occurrence on the replay screen.
[See "Replay" on page 228.](#) If the message requested is older than the oldest chart time/data available a message box will appear and jump you to the oldest chart time and date available.
- **Save** - Save the message screen to removable media
- **Clear** - This will delete all the messages for the particular message screen you are in.
- **Print** - Select this and choose to print All the Messages in the list or the Current page that will fill an A4 or Letter size page.

Refer to Application Note 43-TV-07-32 on your CD or website for a list of possible error messages.

Message Format

Table 4.10 : Message Types

| Icon | Type | Description |
|---|--------------------|--|
|  | Alarm | Red Bell = in Alarm and not acknowledged |
|  | Alarm | Green Bell = out of alarm |
|  | Alarm | Green Bell / Black outline = out of alarm and acknowledged |
|  | Alarm | Green/Yellow bell = out Alarm not acknowledged |
|  | Alarm | Red/Green bell = in Alarm and acknowledged |
|  | System/Diagnostics | Information, General (eg. System check) |
|  | System/Diagnostics | Warning! (eg. media error, FTP failure, Timeouts) |
|  | System/Diagnostics | Error (eg. Password failure, power failure, no media) |
|  | Security | Security audit trail |
|  | Security | Log In - open padlock |
|  | Security | Log Out - closed padlock |
|  | Security | Access Failure - No entry sign |
|  | Security | Thermocouple Failure |
|  | User | Mark on Chart and Batch |
|  | User | Start - Logging or Totals |
|  | User | Stop - Logging or Totals |
|  | User | Pause - Logging or Totals |
|  | User | Reset - Logging or Totals |

Process Menu

(Main Menu > Process)

If Max/Min, Totals and Counters can be controlled from this screen.

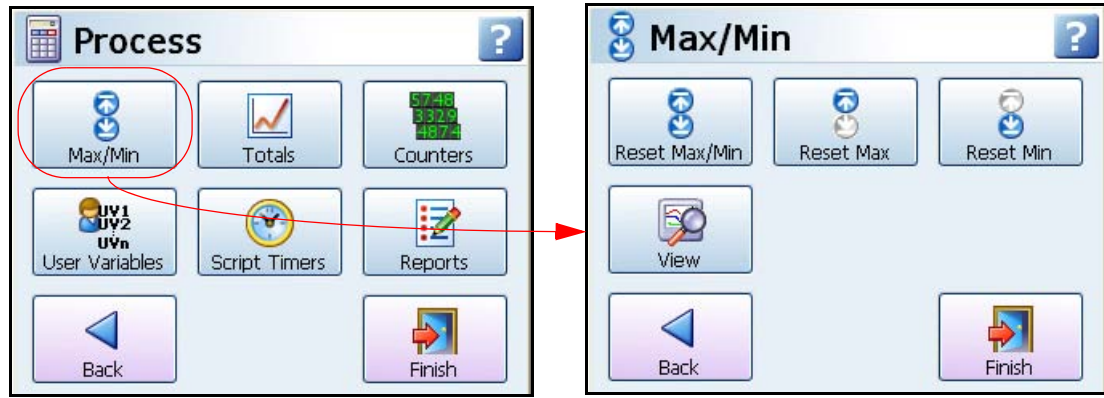

Controls for any process in use:

- **Max/Min** - Reset Max/Min, Maximum or Minimum values by categories;
- **Totals** - Start, Stop, Reset or View Totals by categories
- **Counters** - View and Reset counters by type (Firmware option)
- **User Variables** - Modify and View User variables that have been set up in Maths and Scripting. [See "User Variables" on page 192.](#)
- **Script Timers** - Script timers provide 20 independent timers to be used as desired. [See "Script Timers" on page 192.](#)
- **Reports** - Reports can be generated manually or on a periodical basis using event system. [See "Reports \(Process\)" on page 192.](#)

Note on Groups

Groups of pens need to be set up to use this feature, see ["Pens Menu" on page 84](#)

Max/Min

(Main Menu > Process > Max/Min)

Reset Max/Min, Reset Max or Reset Min values by categories; All, By Groups of pens or by individual pens. Use the **View** button to just display the Max/Min values

- **All** - Select this to reset all values.
- **By Groups** - If Groups of pens have been set up this can be used to reset the max/min values for particular groups of pens. To set up Groups see ["Pens Menu" on page 84](#)
- **By Pen** - Select this to reset max/min values for individual pens.

Totals

(Main Menu > Process > Totals)

Select a button to **Start, Stop, Reset** and **View** Totals. These can be controlled by the following categories:

- **All** - Select this to start, stop or reset all Totals.
- **By Group** - If Groups of pens have been set up this can be used to start, stop or reset particular groups of pens. To set up Groups see *“Pens Menu” on page 84*
- **By Pen** - Select this to start, stop or reset individual pens.
- **View** - Use the View button to just display the Totals values for each totalising pen.

Counters (Process)

(Main Menu > Process > Counters)

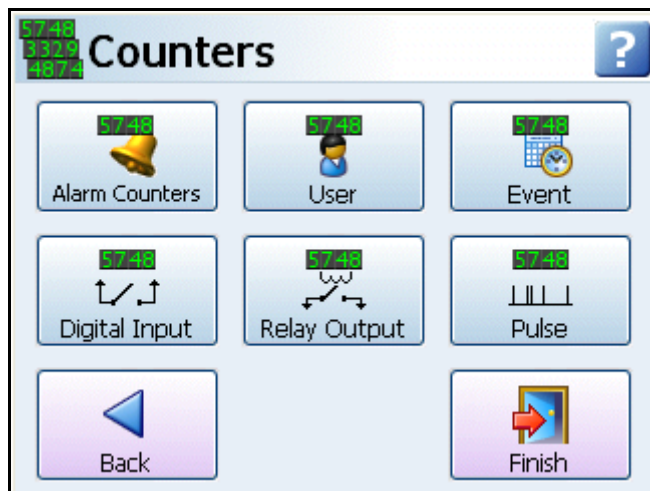

Select the Counters button to **View** and **Reset** counters. Counters have been split into the following types:

- **Alarm Counters** – Reset will give you the option of resetting All alarms, by pen Groups or by individual Pens. View will display all Pens with active alarms. Alarms will be counted providing they are enabled. The count will increase when the pen goes into an alarm state and increase again when the pen goes out of an alarm state.
- **User Counters** – Reset All will do exactly that; reset all of the User Counters. Reset Single will allow you to select which User Counters you wish to reset. View will display all the User Counters that have been set up.
- **Event Counters** - Reset All will reset all of the Event Counters. Reset Single will allow you to select which Event Counters you wish to reset. View will display all the Event Counters that have been set up.
- **Digital Input Counters** - Reset All will reset all of the Digital Input Counters. Reset Single will allow you to select which Digital Input Counters you wish to reset. View will display all the Digital Input Counters that have been set up.
- **Relay Output Counters** - Reset All will reset all of the Relay Output Counters. Reset Single will allow you to select which Relay Output Counters you wish to reset. View will display all the Relay Output Counters that have been set up.
- **Pulse Counters** - Reset All will reset all of the Pulse Counters. Reset Single will allow you to select which Pulse Counters you wish to reset. View will display all the Pulse Counters that have been set up.

User Variables

(Main Menu > Process > User Variables)

User variables provide the user the ability to set values for up to 32 variables to be used within the maths and script.

- **Modify** - allows the user to set and edit the variables.
- **View** - the user can view the variables

The User variable function allows a system to be setup where values can be altered to effect calculations without having to change the configuration. The variables can be used within the Maths and script using UV1 to UV32 and can also be set within the maths using the function UVSET[x,y] where x = the user variable number 1 to 32 and y is the value. The User variables are also non-volatile. See [“Appendix B: Maths Expressions” on page 321](#).

Script Timers

(Main Menu > Process > Script Timers)

Script timers provide 20 independent timers to be used as desired. Previously control and access of script timers was limited to maths functions for use in script but this has now been extended allowing the timers to be controlled using the event system.

Select a Timer that can be stopped, started and reset.

Access to timers via the script is still available in [“Maths Variable and Function Tables” on page 322](#).

Reports (Process)

(Main Menu > Process > Reports)

Reports can be generated manually or on a periodical basis using event system to show daily/weeks/monthly totals, max mins, averages etc., the reports can be printed, e-mailed as attachments or exported to external media. The reports will be in RTF format for use in MS Word or other compatible word processors.

Before a report can be run the report details must be entered in [“Reports Menu” on page 153](#).

To trigger a report using the event system see [“Event Effects” on page 119](#).

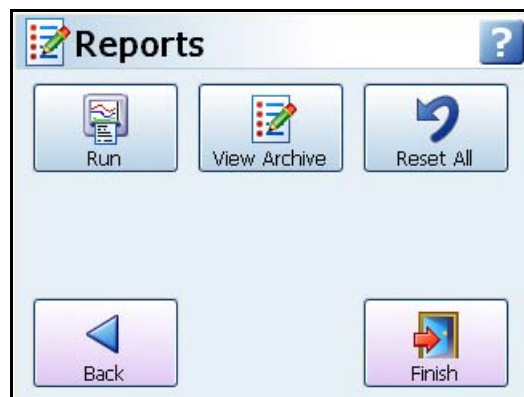

- **Run** - This will list the reports that are available. Before a report can be run the report details must be entered in [“Reports Menu” on page 153](#). Once a report is selected from the list then report is immediately created.

- **View Archive** - This will produce an archive list of all reports that have been run. Select a report on the screen and press the display button. From this screen you have the option to Print or Export the report. The archive will only hold the last 10 reports, not more. The printer settings must be configured in *“Printer Menu” on page 141*. To export the report to a USB key, SD card or Network Share folder (NAS), ensure the media is fitted to the recorder and there is enough memory available.

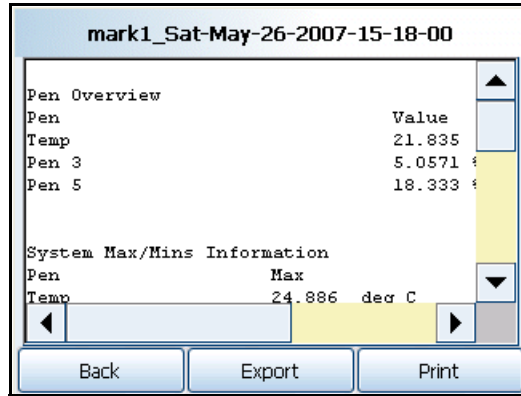

- **Reset All** - This action will reset all hourly, daily, weekly and monthly max/mins, totals and averages. System max/mins and totals shall remain unaffected. A warning dialog will appear to ask if you are sure you wish to continue.

Figure 4.8 Email Report example

| Recorder Name: QIC 03 | | |
|---|------------------------------|------------------------------|
| Recorder Serial Number: 100076 | | |
| Recorder ID: 19 | | |
| Report name: Report 1 | | |
| Report generated on: Tue Jan 29 2008 09:41:26 | | |
| Pen Overview | | |
| Pen | Value | |
| TCT | 8.3737 deg C | |
| TCJ | 19.189 deg C | |
| Pen 7 | Invalid | |
| Hourly Max/Mins between 22h:00m:00s and 22h:59m:59s 24/01/2008 | | |
| Pen | Max | Min |
| TCT | 3.66 deg C @ 22h:07m:55s | 2.56 deg C @ 22h:26m:42s |
| TCJ | 17.99 deg C @ 22h:04m:04s | 17.11 deg C @ 22h:34m:55s |
| Hourly Averages between 22h:00m:00s and 22h:59m:59s 24/01/2008 | | |
| Pen | Average | |
| TCT | 3.10 deg C | |
| TCJ | 17.61 deg C | |
| Reviewed By..... | Date..... | Comment..... |
| Checked By..... | Date..... | Comment..... |
| Page 1 | | |

Status Menu

(Main Menu > Status)

Use the Status menus to easily check on the current configuration of the recorder. A number of status information screens are available to the user, these will provide information for reporting and diagnostic purposes. All Status screens can be saved to removable media or printed.

For AMS2750 mode a new TC Usage button is displayed middle right on the menu screen. Please refer to [“Thermocouple Usage Tracking \(AMS2750\)” on page 390](#).

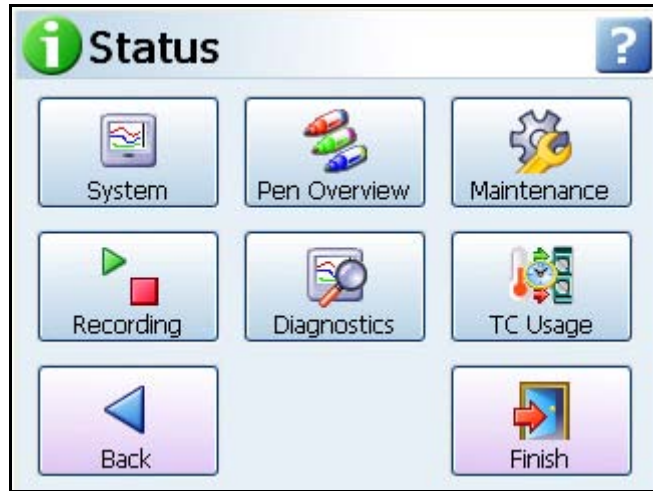

The following Status screens are available

- **System** - Contains general information about the recorder setup such as Device information, software and firmware versions and the recorder's IP address. Plus a list of Firmware options and I/O cards in the recorder, [See “System” on page 195](#).
- **Pen Overview** - Each pen is displayed with full configuration details, including: Pen, Value, Name, Maths, Scale, In Alarm, Pen Rate, Alarm, Total, and Group. [See “Pen Overview” on page 197](#).
- **Maintenance** - The recorder keeps track of important “life actions” for improved diagnostics and preventative maintenance notification. Health Watch/Maintenance is available as a firmware option. [See “Maintenance” on page 198](#).
- **Recording** - Shows the current logging status of all pens within the system: Pen, Value, Recording, Log Rate, Alarm Rate and Group. [See “Recording” on page 199](#).
- **Diagnostics** - Complete diagnostics is shown for each of the following categories: Hardware (including Analogue In, Analogue Out, Digital IO and Pulse Inputs), Events, Comms and Media. This is an option and requires firmware credits to be activated. [See “Diagnostics” on page 200](#).
- **TC Usage** - For AMS2750 TUS and Process modes only. Please refer to [“Thermocouple Usage Tracking \(AMS2750\)” on page 390](#)

Saving Screens

All Status screens can be saved as portable .rtf files onto removable media. These can be transferred to another location and kept for records or sent via email for troubleshooting and maintenance issues.

Printing Screens

All the Status screens have a Print button, to execute this, the printer must first be configured in [“Network Admin” on page 98](#) and in the [“Printer Menu” on page 141](#). For details on suitable printer types see [“Print Support \(USB 2.0\)” on page 44](#).

The Print function is a firmware option that is selectable from the Factory menu > [“Credits” on page 131](#).

System

(Main Menu > Status > System)

The System status menu is divided into three more sub sections: General, Options and IO Cards. Each one will display the current status of the recorder for each category.

General

(Main Menu > Status > System > General)

Displays the version status for the different types of firmware, hardware and current recorder information.

Table 4.11 : Example: System Version Status

| Options | Version |
|--------------------|---|
| ID | 0001 |
| Name | Minitrend GR |
| Serial No. | * * * * * |
| Processor | ***MHz |
| Firmware | 100.1 |
| Firmware Data | 16:33:33 Oct 11 2006 |
| Build Number | 25 Beta / Production |
| Bridge Firmware | ** |
| Platform | 5.** |
| Boot Loader | 1.** |
| Mac address | 00-d0-6e-**-**-** |
| IP Address | 160.221.***.*** |
| Front USB | Host Mode |
| Internal Mem Id - | This number is made up from the size of the memory card and what type of format it is. Eg 256T16 = 256MB size formatted to TFAT16 |
| *Database Size | **.*Mb |
| SD Card | *.*MB/***.**MB |
| USB 1 | ***.*MB/****.*MB |
| USB 2 | Empty |
| Password Node Type | Standalone |

Go **Back** to return to the previous screen or select **Print** to print the screen or **Save** screen to removable media. *See “Database Size Management” on page 261.

Options

(Main Menu > Status > System > Options)

Displays a list of firmware options available and which ones are enabled.

For more information see See “Section 7: Firmware Options” on page 241.

Table 4.12 :

| Options | Credits | Enabled |
|-----------------------------------|------------------------|------------|
| Full Math | 4 | ✓ or ✗ |
| Scripting (+ Full Maths) (Note 2) | 6 | ✓ or ✗ |
| Events | 6 | ✓ or ✗ |
| Fast Scan (Note 2) | 5 | ✓ or ✗ |
| Totals | 4 | ✓ or ✗ |
| Custom Screens (Note 2) | 4 | ✓ or ✗ |
| Reports | 3 | ✓ or ✗ |
| AMS2750 Process (Note 3) | 5 | ✓ or ✗ |
| Maintenance | 2 | ✓ or ✗ |
| Printing | 2 | ✓ or ✗ |
| AMS2750 TUS (Note 3) | 10 | ✓ or ✗ |
| Batch | 5 | ✓ or ✗ |
| Counters | 3 | ✓ or ✗ |
| Modbus Master | 10 | ✓ or ✗ |
| Remote View | 3 | ✓ or ✗ |
| Email | 3 | ✓ or ✗ |
| Pwd Net Sync | 5 | ✓ or ✗ |
| Secure Comms | 3 | ✓ or ✗ |
| Extra Pens | 2 (4 pens) | Total Pens |
| Hardware Lock | 2 | ✓ or ✗ |
| Password CFR (Note 1) | NA | ✓ or ✗ |
| Total Credits | no. used/no. available | NA |

(Note 1) Password CFR - (ESS - Extended Security System). This will only appear in the list if this feature is enabled in the recorder. It cannot be enabled by the firmware credit system - contact **Honeywell** for details.

(Note 2) not available for the **eZtrend GR**.

(Note 3) AMS2750 Process and AMS2750 TUS credits cannot be enabled at the same time

Go **Back** to return to the previous screen or select **Print** to print the screen or **Save** screen to removable media.

IO Cards

(Main Menu > Status > System > IO Cards)

This will display the Slot position of each card in the recorder. The Card Type is identified as Analogue I/P, Alarm/Digital I/O, Analogue O/P or Pulse Input. The number of Channels on each card eg. Digital I/O 1-16. The Firmware Version of the card is displayed and the Board Revision.

Table 4.13 : Example of IO Card Status for a Minitrend GR

| Slot | Card Type | Channels | FW Version | Board Revision |
|------|--------------|----------|------------|----------------|
| A | Analogue I/P | 1-8 | A*-00* | 0 |
| B | Pulse | 9-12 | A*-00* | 1 |
| G | Digital I/O | 1-16 | A*-00* | 0 |

Go **Back** to return to the previous screen or select **Print** to print the screen or **Save** screen to removable media.

Pen Overview

(Main Menu > Status > Pen Overview)

Each pen is displayed with full configuration details.

- **Pen** - Displays the pen number and ticked if it is enabled
- **Value** - Displays the current reading for this pen
- **Name** - Pen name or number
- **Maths** - Displays any Maths calculation applied to this pen or the Analogue Input channel for this pen. Summarised to M for any Maths expressions.
- **Scale** - Displays the High and Low limits of the scale range for this pen
- **In Alarm** - Displays the current status of the alarm, tick = active and a cross = inactive.
- **Pen Rate** - This displays the fastest of all dependencies
- **Alarm** - Displays how many alarms are enabled on this pen
- **Total** - This will be ticked if a totaliser has been enabled on this pen
- **Group** - Displays the group number if this pen has been allocated to a group.

Go **Back** to return to the previous screen or select **Print** to print the screen or **Save** screen to removable media.

Maintenance

(Main Menu > Status > Maintenance)

The recorder keeps track of important “life actions” for improved diagnostics and preventative maintenance notification.

The Maintenance button will become active when Maintenance is selected as a firmware option. To enable this go to “Options” on page 196.

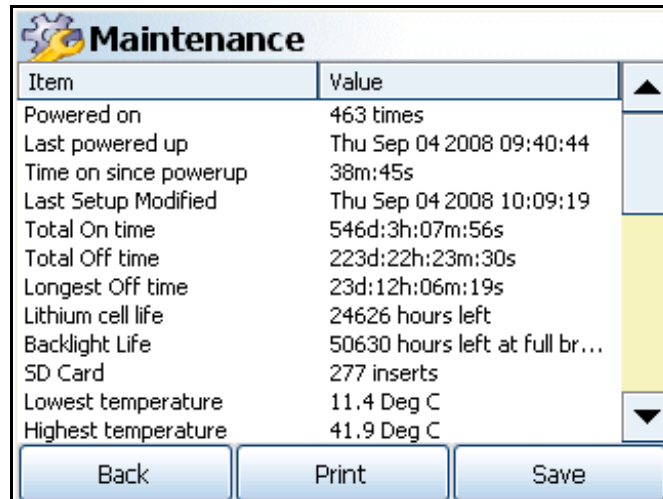

| Item | Value |
|-----------------------|--------------------------------|
| Powered on | 463 times |
| Last powered up | Thu Sep 04 2008 09:40:44 |
| Time on since powerup | 38m:45s |
| Last Setup Modified | Thu Sep 04 2008 10:09:19 |
| Total On time | 546d:3h:07m:56s |
| Total Off time | 223d:22h:23m:30s |
| Longest Off time | 23d:12h:06m:19s |
| Lithium cell life | 24626 hours left |
| Backlight Life | 50630 hours left at full br... |
| SD Card | 277 inserts |
| Lowest temperature | 11.4 Deg C |
| Highest temperature | 41.9 Deg C |

Buttons: Back, Print, Save

Once enabled this screen will keep the following information:

- **Powered on** - How many times the recorder has had the power turned on
- **Last Power up** - The last time the recorder had been turned on
- **Time On since power up** - The amount of time since the recorder was last turned on
- **Last Setup Modified** - displays the last Day, Month and Time the setup was last modified.
- **Total On time** - How much time the recorder has had the power turned on
- **Total Off time** - How much time the recorder has had the power turned off
- **Longest Off time** - How long was the longest time period the recorder was powered off
- **Lithium cell life** - Approximately how much battery time is left
- **Backlight Life** - Approximately how many hours of Back light time left
- **SD Card** - How many times the SD card has been inserted. SD card is available as a credit option for the **eZtrend GR**
- **Lowest temperature** - Displays the lowest ambient temperature detected so far
- **Highest temperature** - Displays the highest ambient temperature detected so far
- **AI last factory cal *** - When the last factory calibration was made to this Analogue Input card. Eg. in card slot A

- **AI last user cal **:*** - When the last user calibration was made to this Analogue Input card. Eg in slot position A, input 1. All channels will be listed per channel.

| Item | Value |
|----------------------|--------------------------|
| AI last user cal A:7 | Fri Mar 07 2007 13:50:25 |
| AI last user cal A:8 | Fri Mar 07 2007 13:50:25 |
| Relay 1 cycle(s) | 0 cycle(s) |
| Relay 2 cycle(s) | 0 cycle(s) |
| Relay 3 cycle(s) | 0 cycle(s) |
| Relay 4 cycle(s) | 0 cycle(s) |
| Relay 5 cycle(s) | 0 cycle(s) |
| Relay 6 cycle(s) | 0 cycle(s) |
| Relay 7 cycle(s) | 0 cycle(s) |
| Relay 8 cycle(s) | 0 cycle(s) |
| Fixed | 0 cycle(s) |

Buttons: Back, Print, Save

- **Relay * cycle(s)** - Displays the amount of relay cycles per relay listed.
- **Fixed** - reports common relay output cycles

Go **Back** to return to the previous screen or select **Print** to print the screen or **Save** screen to removable media.

Recording

(Main Menu > Status > Recording)

| Pen | Value | Recording | Log Rate | Alarm Rate | Pre-Trig | Group |
|------|-----------|-------------------|----------|------------|----------|----------|
| 1 ✓ | 14.46 % | Fuzzy | 10Hz ✓* | 2Hz ✗ | ✓ | No Group |
| 2 ✓ | 25.36 % | Continuous Sample | 10Hz ✓* | 2Hz ✗ | ✓ | No Group |
| 3 ✓ | 49.92 % | Continuous Sample | 10Hz ✓* | 2Hz ✗ | ✗ | No Group |
| 4 ✓ | Overrange | Continuous Sample | 10Hz ✓* | 2Hz ✗ | ✗ | No Group |
| 5 ✓ | Overrange | Continuous Sample | 10Hz ✓* | 2Hz ✗ | ✗ | No Group |
| 6 ✓ | Overrange | Continuous Sample | 10Hz ✓* | 2Hz ✗ | ✗ | No Group |
| 7 ✓ | 49.92 % | Continuous Sample | 10Hz ✓* | 2Hz ✗ | ✗ | No Group |
| 8 ✓ | 49.92 % | Continuous Sample | 10Hz ✓* | 2Hz ✗ | ✗ | No Group |
| 9 ✓ | 3.48 % | Continuous Sample | 10Hz ✓* | 2Hz ✗ | ✓ | No Group |
| 10 ✓ | 70.96 % | Continuous Sample | 10Hz ✓* | 2Hz ✗ | ✗ | No Group |

Buttons: Back, Print, Save

Shows the current logging status of all pens within the system:

- **Pen** - Displays the Pen number and will display a tick when recording and a cross when recording has stopped.
- **Value** - Displays the current pen value

- **Recording** - Displays either Continuous or Fuzzy logging
- **Log Rate** - Displays the Log rate set, in Hertz. A tick denotes if it is enabled and a star will indicate the current log rate
- **Alarm Rate** - Displays the alarm rate, in Hertz, if this has been set up to change when the pen goes into an active alarm state. A tick denotes if it is enabled and a star will indicate the current log rate
- **Pre-Trigger** - Each Pen will display it's pre-trigger enabled status from within the Pen logging status display.
- **Group** - Displays the name of the group that this pen has been assigned to.

Go **Back** to return to the previous screen or select **Print** to print the screen or **Save** screen to removable media.

Diagnostics

(Main Menu > Status > Diagnostics)

The Diagnostics button will become active when Maintenance is selected as a firmware option. To enable this go to *“Options” on page 196.*

- **Hardware** - *“Hardware Status” on page 201.*
- **Events** - *“Events Status” on page 203.*
- **Comms** - *See “Comms Status” on page 204.*
- **Media** - *See “Media Status” on page 205.*

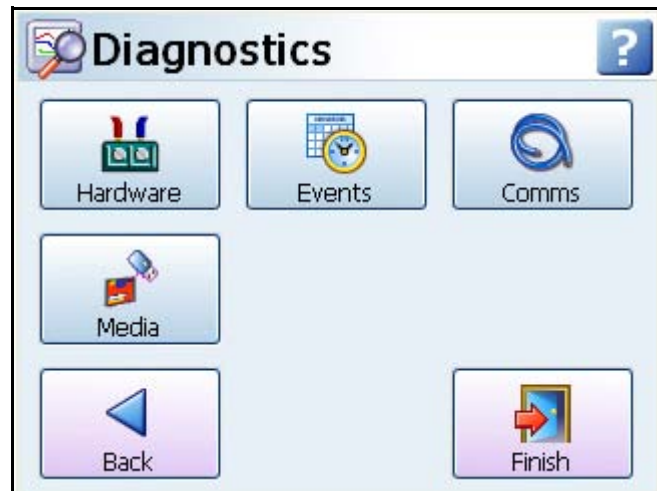

Hardware Status

(Main Menu > Status > Diagnostics > Hardware)

Complete diagnostics are shown for each of the following categories:

- **Analogue In Status** - See [“Analogue In Status” on page 201.](#)
- **Analogue Out Status**- See [“Analogue Out Status” on page 202.](#)
- **Alarm/Digital IO Status** - See [“Alarm/Digital IO Status” on page 202.](#)
- **Pulse Input Status** - See [“Pulse Inputs Status” on page 203.](#)

Analogue In Status

(Main Menu > Status > Diagnostics > Hardware > Analogue In)

| Channel | Input | Range | Cal | Sample Rate | Sqrt | Sensor comp | Pen | CJC |
|-----------|----------|----------------|---------|-------------|------|-------------|-----|-------|
| A:1 (1) ✓ | -0.71 mV | Type J (±50mV) | Factory | 2Hz (500ms) | ✗ | None | 1 | 28... |
| A:2 (2) ✓ | 0.01 mV | Type T (±25mV) | Factory | 2Hz (500ms) | ✗ | Dual | 2 | 28... |
| A:3 (3) ✓ | -0.02 V | ±12V | Factory | 2Hz (500ms) | ✗ | Dual | 3 | - |
| A:4 (4) ✓ | -0.02 V | ±12V | Factory | 2Hz (500ms) | ✗ | None | 4 | - |
| A:5 (5) ✓ | -0.02 V | ±12V | Factory | 2Hz (500ms) | ✗ | None | 5 | - |
| A:6 (6) ✓ | -0.02 V | ±12V | Factory | 2Hz (500ms) | ✗ | None | 6 | - |
| A:7 (7) ✓ | -0.02 V | ±12V | Factory | 2Hz (500ms) | ✗ | None | 7 | - |
| A:8 (8) ✓ | -0.02 V | ±12V | Factory | 2Hz (500ms) | ✗ | None | 8 | - |

Navigation: Back, Print, Save

- **Channel** - Displays the Slot position eg. A, B, or C, D, E, F, the Analogue Input number and the system channel position. This will show a tick if this channel is enabled.
- **Input** - Displays the current Analogue Input reading for this channel*. See [“Thermocouple Active Burnout Status” on page 202.](#)
- **Range** - Displays the current Range Type set for this channel, eg. +/-12V
- **Calibration** - Displays the type of calibration for this channel either Factory or User Cal
- **Sample Rate** - Displays the current Sample rate for this channel.
- **SQRT** - If ticked the square root extract is enabled on this channel to linearise a non-linear input.
- **Sensor Comp** - This will display if any type of sensor compensation applied to this channel.
- **Pen** - Displays which Pen scale is being used to display this analogue input.
- **CJC** - Only for Thermocouple inputs. Displays the final adjusted value of a Cold Junction Calibration on this channel in degrees C.

Go **Back** to return to the previous screen or select **Print** to print the screen or **Save** screen to removable media.

*Displayed in the Input column may also be the Thermocouple Active burnout status

Table 4.14 : Thermocouple Active Burnout Status

| Label | Descriptions |
|---------------|---|
| Disabled | Active burnout disabled |
| Normal | Active burnout enabled, input ok |
| Degraded | Thermocouple degraded (difference measurement: 10Ω to 99Ω increase**) |
| Failing | Thermocouple Failing (difference measurement: 100Ω to 200Ω increase**) |
| Failing | Thermocouple Failing (absolute measurement: over 230Ω increase**) |
| Almost Failed | Thermocouple Almost Failed (difference measurement: over 200Ω, not failed) |
| Almost Failed | Thermocouple Almost Failed (absolute measurement: 330Ω to 2kΩ) |
| Open Circuit | Thermocouple Failed, No data on passive channel, Thermocouple Failed, but no error on passive thermocouple channel Thermocouple Failed, also failed status on passive channel |
| Short Circuit | Possible thermocouple wiring short circuit detected (significant reduction in Ω) |

**any increase is measured from the level when the recorder is first powered up.

Analogue Out Status

(Main Menu > Status > Diagnostics > Hardware > Analogue Out))

Not available for the **eZtrend GR**.

- **Channel** - Displays the Slot position, eg. B, E or F, the Analogue Output number and the system channel position. This will show a tick if this channel is enabled.
- **TX Pen** - Displays which pen is transmitting the signal
- **Range** - Displays the Output range set. A tick here will indicate this is over-range.
- **Output** - Displays the current Analogue Output reading for this channel.

Go **Back** to return to the previous screen or select **Print** to print the screen or **Save** screen to removable media.

Alarm/Digital IO Status

(Main Menu > Status > Diagnostics > Digital IO)

- **Channel** - Displays the Slot position, eg. G, H or I, the Digital IO number and the system channel position. This will show a tick if this channel is enabled. Fixed refers to the common relay output on the power board (24V relay)
- **Input/Output/Pulse** - Displays what activity is on this channel, Input, Output or Pulse Input.
- **Alarm** - Displays the Pen number and the Alarm number that activates the digital output when the alarm is active. The Alarm has to be set to Relay out.
- **Status** - Displays the current state of the digital input on this channel or pulsed if Pulse Out is selected. The relay is displayed as open or closed.
- **Counters** - Displays the counter number when active.
- **Duration** - Displays the Output Pulse duration set.

Go **Back** to return to the previous screen or select **Print** to print the screen or **Save** screen to removable media.

Pulse Inputs Status

(Main Menu > Status > Diagnostics > Hardware > Pulse Inputs)

Not available for the **eZtrend GR**.

- **Channel** - Displays the Slot position, eg. A, B, C, D, E or F, the Pulse Input number and the system channel position. This will show a tick if this channel is enabled.-
- **Frequency/Count** - Displays the input mode, fixed as Frequency (in Hertz)
- **Input** - Displays the current Pulse Input reading for this channel (in Hertz)

Go **Back** to return to the previous screen or select **Print** to print the screen or **Save** screen to removable media.

Events Status

(Main Menu > Status > Diagnostics > Events)

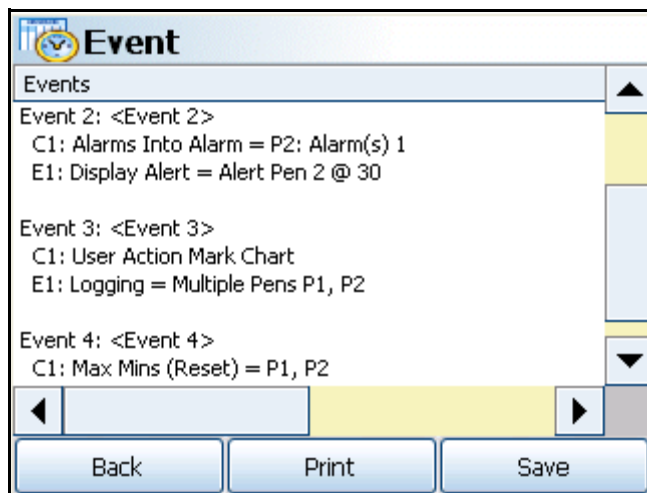

This status screen displays all the currently enabled Events as they occur.

Each event displays the event number <Event 1> followed by the event information:

- C1: = Cause 1
- C2: = Cause 2
- C3: = Cause 3
- C4: = Cause 4
- E1: = Effect 1
- E2: = Effect 2
- E3: = Effect 3
- E4: = Effect 4

If an Event has not been enabled no event will be listed in the status screen

If part of an event is not enabled one * will appear next to the incomplete cause or effect.

If a Cause is enabled but not an Effect or an Effect is enabled but not a Cause two ** will appear next to the incomplete part of the event.

When a scheduled event is displayed it will show the next time a scheduled cause is due.

NOTICE

Remember that Cause 1, 2, 3 **OR** Cause 4 will trigger Effect 1, 2, 3 **AND** Effect 4. Cause and Effect numbers are not linked eg. Cause 1 and Effect 1 are **not** linked.

Comms Status

(Main Menu > Status > Diagnostics > Comms)

- **General** - See “General Status” on page 204.
- **Modbus** - See “Modbus Status” on page 204.
- **SMTP** - See “SMTP Status” on page 205.
- **FTP** - See “FTP Status” on page 205.
- **Peers** - See “Peers Status” on page 205.

This screen contains a description of the type of comms currently being used and its status.

General Status

(Main Menu > Status > Diagnostics > Comms > General)

- Description and Status of comms on the recorder. Displays Ethernet or RS485 in an Active or inactive state and the recorder’s IP address

Modbus Status

(Main Menu > Status > Diagnostics > Comms > Modbus)

| ModBus Status. | |
|-----------------|---------------------------|
| Description | Status |
| Transport | Ethernet |
| Address | Dynamic:160.221.36.31:... |
| Device ID | 1 |
| Protocol | ModBus-X |
| Good Messages | 0 |
| Bad Messages | 0 |
| Internal Errors | 0 |

Description and Status of Modbus Transport - Ethernet

- Transport - Ethernet or RS485
- Address - the IP address of your recorder and if it is fixed or Dynamic
- Device ID - Recorder ID number
- Protocol - Modbus or Modbus-X
- Good Messages - Number of messages being transferred successfully

- Bad Messages - Number of corrupt or rejected messages eg. a checksum failure
- Internal Errors - Number of Hardware errors

SMTP Status

(Main Menu > Status > Diagnostics > Comms > SMTP)

(Simple Mail Transfer Protocol) - Displays the Type, Time, Date and Message details for Email transfers

FTP Status

(Main Menu > Status > Diagnostics > Comms > FTP)

(File Transfer Protocol) - Displays the Type, Time, Date and Message details for FTP transfers

Peers Status

(Main Menu > Status > Diagnostics > Comms > Peers)

Displays all recorders available on the network. The screen will display the recorder name, what version of Firmware is installed, ID number and Network Name and IP address.

It also displays the recorder's network sync status to show if the recorder is part of a password group. It will display either Master, Slave or a Stand Alone recorder (not belonging to a net sync group).

The last column displays which Password Net Sync group each recorder belongs to. Stand Alone recorders will be blank.

The Peers Diagnostic Status screen only gets updated when a rescan is done, if you remove a peer from the network it still shows in the Comms Diagnostic Peers Status screen until another rescan. A rescan will be done when a recorder come online (startup) or a change is made to password netsync.

If you experience any security issues using peers, see ["Internet Security Settings" on page 277](#).

Messages - The Messages list displays the Peer to Peer status. Thus includes the Type of message (usually a system password message), Time, Date and the Message information. This screen can be cleared or printed.

Go **Back** to return to the previous screen or select **Print** to print the screen or **Save** screen to removable media.

Media Status

(Main Menu > Status > Diagnostics > Media)

- **Pen** - Pen number
- **Rate** - Pen speed
- **Store Size** - How much memory is allocated to this pen
- **Store Time** - How much storage time is available
- **Remaining** - How much memory is left before data is over-written.

Store Size, Store Time and Remaining are dependant of the pen logging speed, how many pens are logging and will be affected by Storage bias allocation of chart and logged data.

Go **Back** to return to the previous screen or select **Print** to print the screen or **Save** screen to removable media.

Finish

When the Finish button is pressed at the end of a new set up or a change to a setup the following options are available.

Commit

This will save the new setup or changes to an existing setup, over-writing the existing one, and implement them into the recorder

Field validation is performed when a change has been made, if a problem is identified, an error message is shown and the field in question clearly marked.

Discard

This will ignore the new setup, or the changes that have been made to the existing setup, and not implement them into the recorder

Commit Later

This gives the user the option for a configuration to be partially completed but to be committed at a later date. This will retain the new set up or the changes to the existing setup until they are required. A partially completed setup will not be maintained over a power failure.

If Commit Later has been executed, a warning message will display for Edit Setup, Edit Layout and User Admin (Passwords) screens. This is to alert the user that the changes have been made to the configuration and not committed in the recorder. The user can Discard the changes or continue to do changes and then Commit them.



Section 5: Security

See “Hardware Configuration Lock” on page 224.

Password Security

Log On/Off

If ESS (Extended Security System) Password security is active on your recorder a password is required to enter the menu system and process screens. Limited access is available without logging on, see [Table 5.1 on page 211](#).

When Log On is required the Log On button will appear in the top right of the Main Menu screen. The Log On button can be set to switch to auto Log Off at a specified period of time. To Log On select the Log On button at the top right of the Main Menu screen.



Log On - User is presented with a user name and password box. First time user login is “Admin”. No password is required. Access for the first time user is removed once the password system has been configured.



Log Off - Once the user has logged on, the option in the Main Menu will turn to Log Off, once selected the user is logged off and returned to the current process screen.

User Log in/Log Out Method

Users can log in and out of the system or web page easily using the touch screen or an attached keyboard.

Users and Groups

Number of Users

The system will support up to 50 users.

Multiple Log On's

Users are allowed to log on to the system more than once, allowing the same user to log on from different areas, e.g. via the user interface and via web browser at the same time.

User Name

Each user must have a user name, this is a maximum of 20 characters in length and cannot be duplicated. Numeric characters and symbols can be used in the user name, but no spaces.

User Group

Each user can be allocated to a group, these are defined as follows

Administrator

Administrator has access to everything, and it is possible to have more than one user at the administrator level. The Administrator will have unlimited access to the system and provide the ability to setup other users.

With the exception of Administrator who has access to everything, the other 4 groups permission areas can be configured, users can then be allocated to a level and they will inherit those permissions.

Permissions

Permissions may also be customised for an individual user, their permissions can be changed to become a customised user. However for global access restrictions, the user must be allocated a security level of Engineer, Supervisor, Technician or Operator, even though the individual permissions will differ.

First Time' Password System Setup

The first time the system is used a default user name and password is available, the user name is "Admin" and will have no password, this is known as the "first time" user. Access to the first time user is removed once the password system has been configured. The first time user is reinstated if the password system is reset.

ESS - Extended Security System (CFR21 Part 11)

The password system allows for user names to be typed in. All logging in and out activity is automatically stored in the audit trail.

If your recorder is fitted with the ESS password system follow these instructions

First Time Password System Setup – Add System Administrator

**Your recorder is configured with ESS – Extended Security System.
This is a password system that cannot be switched off**

Follow these steps on first time power up.

Administrator User name

1. Switch the recorder On
2. From the process screen press the Menu button in the top left of the screen and select the Log In icon in the top right as shown here. 
3. A box will appear and prompt you to enter a User name, enter Admin. This is the first time user login. Access to the first time login is removed once the password system has been configured. The first time user is reinstated if the password system is reset. No password is required for first time login. No password is required for first time login.
4. From the Main menu press the following buttons:

Configure > Passwords > User Admin > Add User

Select "Blank User" and type in your new administrator user name

- Default User name minimum length is 4 characters. (Allows the use of alpha, symbol and numeric characters, no spaces)
 - Default User name maximum length is 20 characters
5. In the Add User menu your new user name will be displayed, select this (default Operator) and change the User Level to "Administrator". Select Finish and Commit.

6. A box will appear when you have successfully added a user, press OK
7. The recorder will return to the process screen.

You have now added an Administrator User Level to the password system. You must now give the new user a password

Administrator Password

1. From the process screen press the Menu button in the top left of the screen and select the Log In icon in the top right as shown here. 
2. A box will appear and you will be prompted for your Administrator user name, which you have just created in items 1 to 7 listed above.
3. The Password dialog box will appear. The recorder enters a default password when a user is added so select "Yes" to change it.
 - Default Password minimum length is 6 characters (requires a minimum of 5 alpha characters. Allows the use of symbols and numeric characters, no spaces)
 - Default Password maximum length is 20 characters
4. Enter your new password, then repeat to confirm.
5. The password dialog will appear confirming the change has been successful.
6. You have now completed creating an Administrator.

You can now enter the password system to check and reset the default Policies, eg. Password Expiry Time. (*Main Menu > Configure > Passwords > User Admin > Policy*)

Refer to the Password section in the User manual for more information.

User Name Description

User names are case dependent however duplicate user names will not be allowed even if case does not match. The user name and password cannot be the same.

Minimum Access Level

If an end user has password enabled and starts a batch, the Operator and Technician levels can log in, enter the setup area, make changes to the setup but when they try to finish and commit, it will come back with a message that says they do not have a high enough access level to perform that function. Once the batch is stopped, the operator and technician level can login to the setup area and make changes. When the batch is running, all users with access levels higher than operator and technician can enter setup, make changes, finish and commit. There will be a message that comes up and says that to perform this function, the batch needs to be stopped and do you want to do that? Answer yes and stop the batch and save the setup changes.

Calendar Function

Day of week restriction is required for all levels apart from Administrator, this will consist of any combinations of 7 days. An everyday selection is available.

Password Policy

See “Policy” on page 165.

Duplicate Passwords

Duplicate passwords are allowed for different users, otherwise this would alert a user that the same password is available on another user login. The User name and password cannot be the same. **Note:** Ensure that passwords entered are a mix of capital letters, small letters, numbers and special characters.

Retry Lockout

A password retry lockout option is available, if the user enters the incorrect password for a preset number of times in a row, the account must be de-activated and only an Administrator can re-activate the account. The account can be reactivated in 2 ways

Retry & Preserve Password

Reset retries (unlock) and preserve password, allowing user to have another try

Retry & Reset Password

Reset retries (unlock) and reset password which must be changed on first login.

User Interface requirements

No Activity Timeout

A “no activity” timeout programmable from 20 to 3600 seconds, which will automatically log out a user after a defined period of inactivity at the menu system or web page.

Level Names

The level names, such as Operator, Technician, Supervisor, Engineer are for internal reference and are displayed as defaults, it is possible for the user to change the group names to suit their personnel structure. This is stored in the policy set up for the Password configuration.

Audit Trail

A full audit trail is available and is stored as a message log.

Trail Rules

The audit trail cannot be turned off and will always be generated for the password system.

Audit Trail Entries

Audit trail is generated for the following actions

- User log On/Off and source (Recorder, Web)
- Failed password attempts
- Areas where access was attempted but denied
- Password expiry
- Inactivity timeouts/auto logouts
- Temporary User entry

Level Permissions

Table 5.1 : Default Level Permissions

| Default user levels of access to areas within the recorder menu system | | | | | | | |
|--|-----------------------------|-------|----------|-----------------|------------|----------|----------------------|
| Permission Area | | Admin | Engineer | Super- visor | Technician | Operator | No Login required |
| Perm Area 1 | Messages | ✓ | ✓ | ✓ | ✓ | ✓ | ✓ |
| Perm Area 2 | Screen | ✓ | ✓ | ✓ | ✓ | ✓ | ✓ |
| Perm Area 3 | Status | ✓ | ✓ | ✓ | ✓ | ✓ | ✓ |
| Perm Area 4 | View Totals | ✓ | ✓ | ✓ | ✓ | ✓ | ✓ |
| Perm Area 5 | View Alarms | ✓ | ✓ | ✓ | ✓ | ✓ | ✓ |
| Perm Area 6 | View Max/Min | ✓ | ✓ | ✓ | ✓ | ✓ | ✓ |
| Perm Area 7 | View Counters | ✓ | ✓ | ✓ | ✓ | ✓ | ✓ |
| Perm Area 8 | Acknowledge Alarms | ✓ | ✓ | ✓ | ✓ | ✓ | |
| Perm Area 9 | Configure Alarms | ✓ | ✓ | ✓ | ✓ | ✓ | |
| Perm Area 10 | Batch Control | ✓ | ✓ | ✓ | ✓ | ✓ | |
| Perm Area 11 | Recording | ✓ | ✓ | ✓ | ✓ | ✓ | |
| Perm Area 12 | Change Password | ✓ | ✓ | ✓ | ✓ | ✓ | |
| Perm Area 13 | Main Configure Menu | ✓ | ✓ | ✓ | ✓ | ✓ | |
| Perm Area 14 | Configure Counters | ✓ | ✓ | ✓ | ✓ | | |
| Perm Area 15 | Configure Totals | ✓ | ✓ | ✓ | ✓ | | |
| Perm Area 16 | Configure Max/Min | ✓ | ✓ | ✓ | ✓ | | |
| Perm Area 17 | Load/Save Setups | ✓ | ✓ | ✓ | ✓ | | |
| Perm Area 18 | Main Setup Menu | ✓ | ✓ | ✓ | ✓ | | |
| Perm Area 19 | Edit Setup & Edit Recording | ✓ | ✓ | ✓ | | | |
| Perm Area 20 | General Setup Menu | ✓ | ✓ | ✓ | | | |
| Perm Area 21 | Printer Setup | ✓ | ✓ | ✓ | | | |

Table 5.1 : Default Level Permissions

| Default user levels of access to areas within the recorder menu system | | | | | | | |
|--|--|-------|----------|-----------------|------------|----------|----------------------|
| Permission Area | | Admin | Engineer | Super- visor | Technician | Operator | No Login required |
| Perm Area 22 | Batch Setup | ✓ | ✓ | ✓ | | | |
| Perm Area 23 | Configure Settings | ✓ | ✓ | ✓ | | | |
| Perm Area 24 | Configure Layout | ✓ | ✓ | ✓ | | | |
| Perm Area 25 | Screen Setup | ✓ | ✓ | ✓ | | | |
| Perm Area 26 | Pens | ✓ | ✓ | ✓ | | | |
| Perm Area 27 | Events/ Counters | ✓ | ✓ | ✓ | | | |
| Perm Area 28 | General (All) Incl. Hardware Lock | ✓ | ✓ | | | | |
| Perm Area 29 | Comms | ✓ | ✓ | | | | |
| Perm Area 30 | Comms - Modbus | ✓ | ✓ | | | | |
| Perm Area 31 | Comms - Web/FTP | ✓ | ✓ | | | | |
| Perm Area 32 | Comms - SNTP | ✓ | ✓ | | | | |
| Perm Area 33 | Comms - TCP/IP | ✓ | ✓ | | | | |
| Perm Area 34 | Comms - Email | ✓ | ✓ | | | | |
| Perm Area 35 | Field IO I/O+AMS2750 | ✓ | ✓ | | | | |
| Perm Area 36 | Passwords | ✓ | | | | | |
| Perm Area 37 | View Status via Web Page | ✓ | ✓ | | | | |
| Perm Area 39 | Full Control via Web Page | ✓ | ✓ | | | | |
| Perm Area 40 | Calibrate Screen | ✓ | ✓ | | | | |
| Perm Area 41 | User Variables | ✓ | ✓ | ✓ | ✓ | ✓ | |
| Perm Area 42 | Clear Popup Alert | ✓ | ✓ | ✓ | ✓ | | |

Table 5.1 : Default Level Permissions

| Default user levels of access to areas within the recorder menu system | | | | | | | |
|--|-------------------------------|-------|----------|-----------------|------------|----------|----------------------|
| Permission Area | | Admin | Engineer | Super- visor | Technician | Operator | No Login required |
| Perm Area 43 | Context Menu | ✓ | ✓ | ✓ | ✓ | | |
| Perm Area 44 | Clear Messages | ✓ | ✓ | | | | |
| Perm Area 45 | Reports, Run and View | ✓ | ✓ | ✓ | ✓ | ✓ | |
| Perm Area 46 | Reports, Modify and Reset All | ✓ | ✓ | | | | |
| Perm Area 47 | Script Timers | ✓ | ✓ | ✓ | ✓ | ✓ | |

Default Password Access

Default password access is set up within the recorder and can be changed by the Administrator or the Administrator can assign another user to change the access permissions.

Default permissions

- **Administrator Access** is for the Administrator level only
- **Engineer Access** is for Engineers and above (Administrator level)
- **Supervisor Access** is for Supervisors and above (incl. Engineer and Administrator levels)
- **Technician Access** is for Technicians and above (incl. Supervisor, Engineer and Administrator levels)
- **Operator Access** is for Operators and above (incl. Technicians, Supervisors, Engineers and Administrator levels)
- **No Login** gives access only to unrestricted areas.

Access levels can change for each menu, for example Operator or above access is required to get to the Configure menu. Once in the Configure menu the operator level can only access the Passwords button, Setup is Technician or above access and Layout and Settings are Supervisor or above access.

Figure 5.1 Default password access from the Main menu.

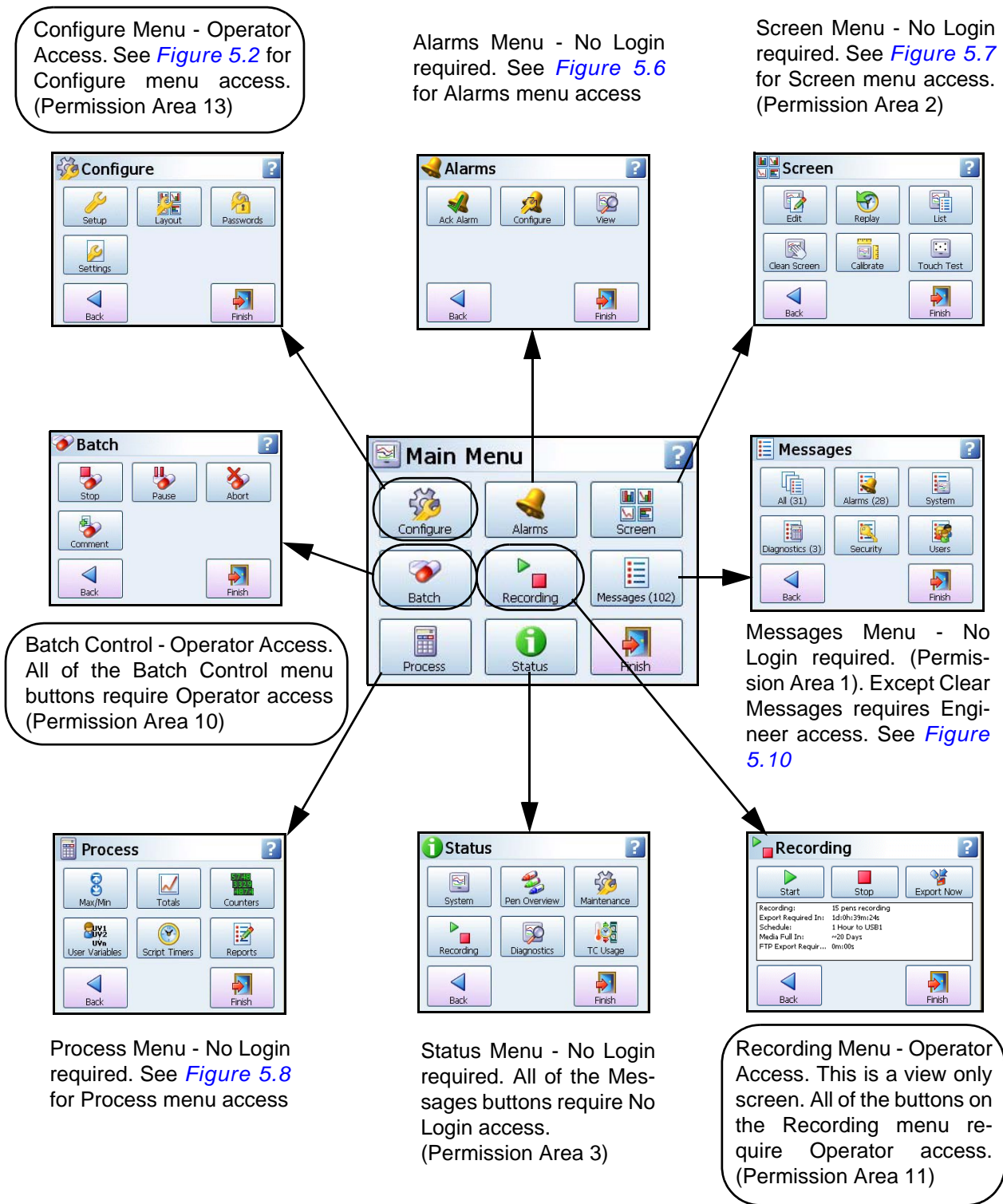
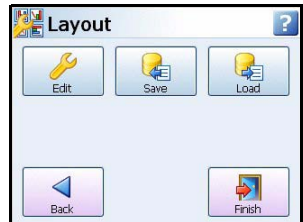

Figure 5.2 Default password access from the Configure menu

Setup menu - Technician access.
See [Figure 5.3](#) for Setup menu access. (Permission Area 18)

Layout menu - Supervisor access.
All of the Layout menu buttons require Supervisor access. (Permission Area 24).
Edit Layout see [Figure 5.7](#)



Configure menu - Operator access (Permission Area 13)
Setup = Technician access
Layout = Supervisor access
Passwords = Operator access
Settings = Supervisor access

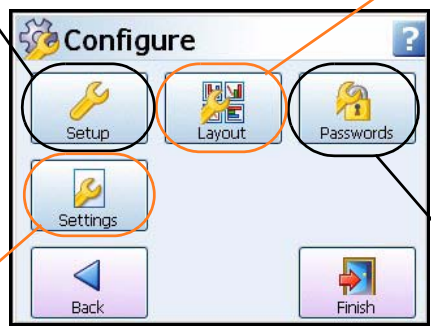

Settings menu - Supervisor access
(Permission Area 23)

Password menu - Operator access.
See [Figure 5.4](#) for Password menu access. (Permission Area 36)

Figure 5.3 Default Password access from the Setup Menu

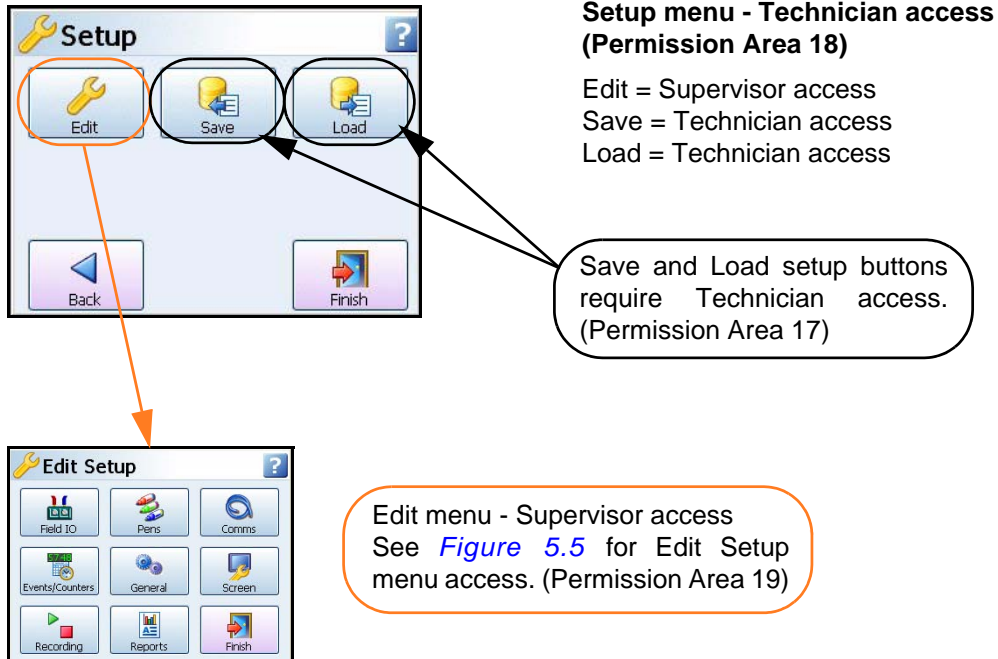

Figure 5.4 Default password access from the Password Menu

Password Menu - Operator access (Permission Area 36)

User Admin - Administrator
 Change Password - Operator access

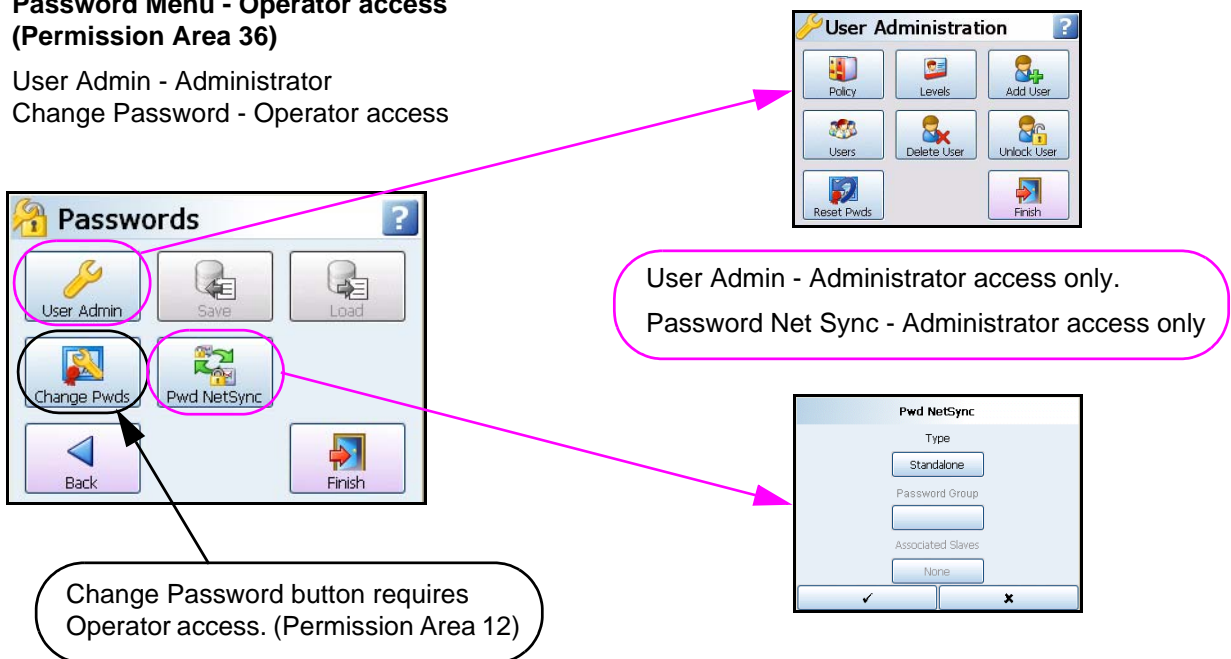
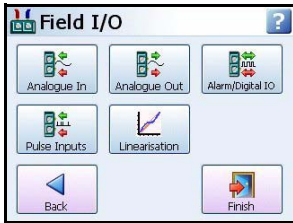
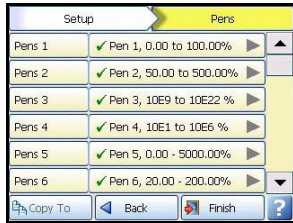

Figure 5.5 Default password access from the Edit Menu

Field I/O Menu ((I/O + AMS2750 if enabled) - Engineer Access. All of this menu requires Engineer access. (Permission Area 35)



Pens Menu - Supervisor Access. (Permission Area 26)



Comms Menu - Engineer Access. See Figure 5.11 for Comms access. All of the Comms menu buttons require Engineer access. (Permission Area 29)

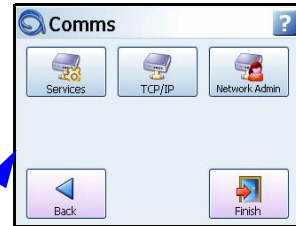

Edit Setup Menu - Supervisor access (Permission Area 19)

Field I/O - Engineer
 Pens - Supervisor
 Comms - Engineer
 Events/Counters - Supervisor
 General - Supervisor
 Screen - Supervisor
 Recording - Supervisor
 Reports - Engineer



Events/Counters menus - Supervisor Access. All of the Events and Counters menu buttons require Supervisor access. (Permission Area 27)



Edit Recording - Supervisor Access. (Permission Area 19)

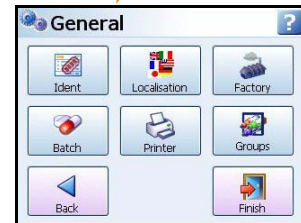

General menu - Supervisor Access. See Figure 5.9 for General menu access. (Permission Area 20)

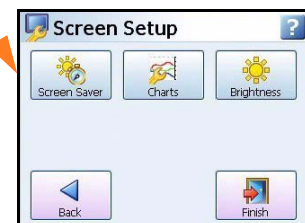

Screen Setup Menu - Supervisor Access. (Permission Area 25)

Reports menu - Engineer Access. (Permission Area 46)



Figure 5.6 Default password access from the Alarms Menu

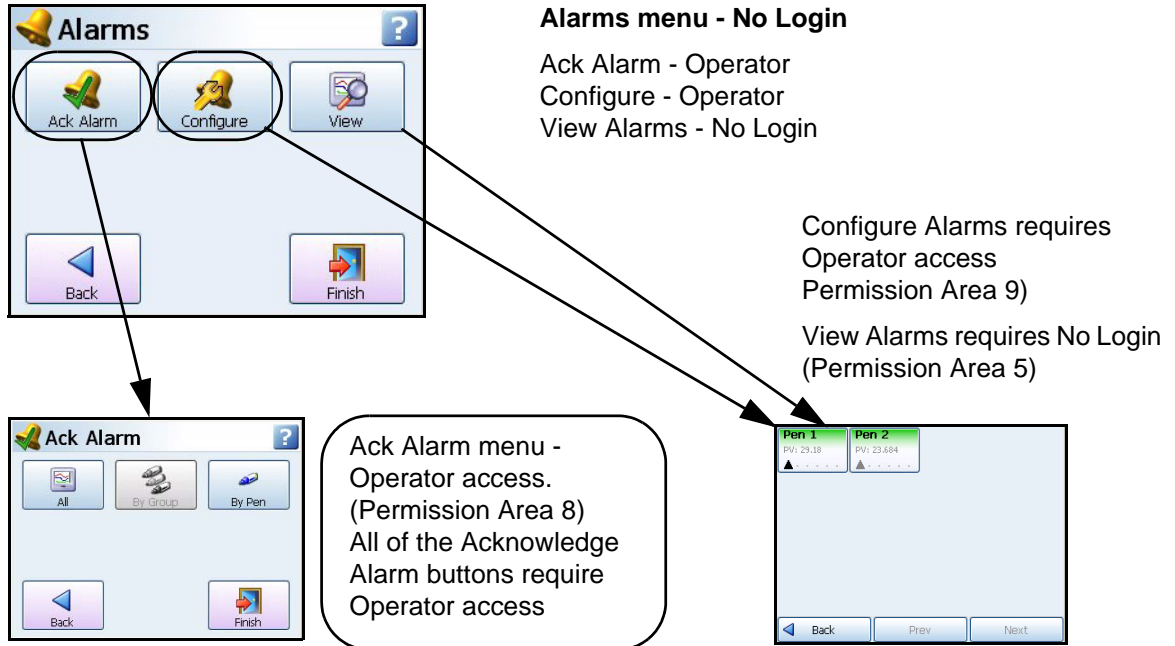

Figure 5.7 Default password access from the Screen Menu and Edit layout menu

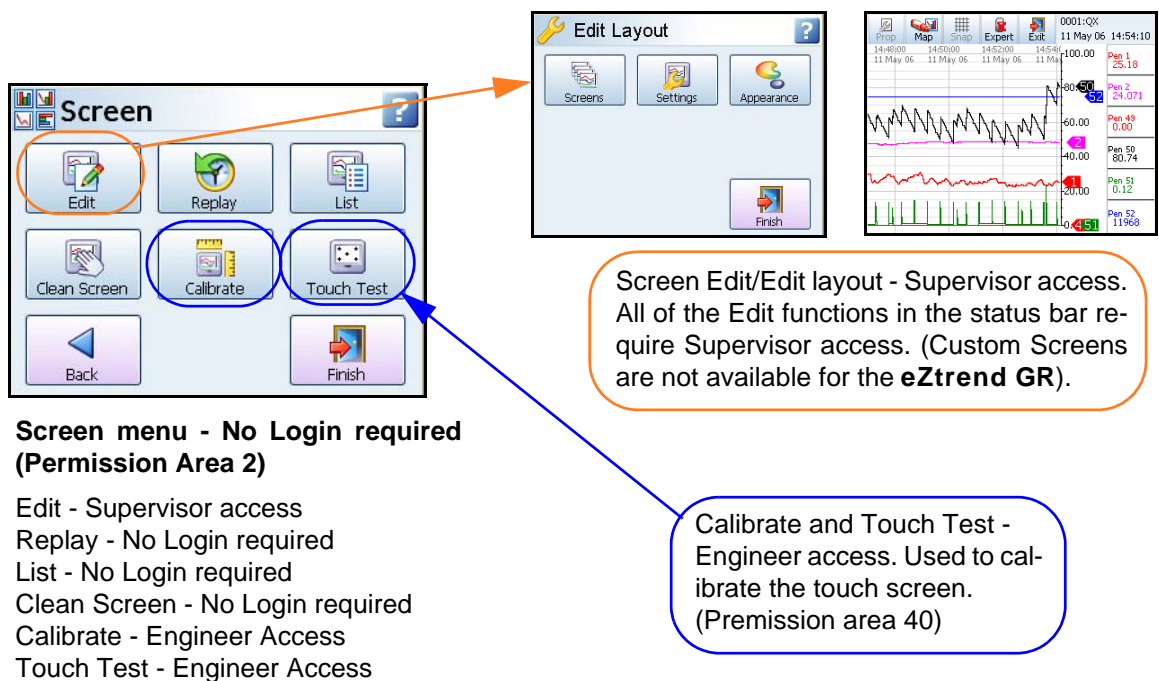

Figure 5.8 Default password access from the Process Menu

Process Menu - No Login required

- Max/Min - No Login
- Totals - No Login
- Counters - No Login
- User Variables - Operator
- Script Timers - Operator
- Reports - Operator

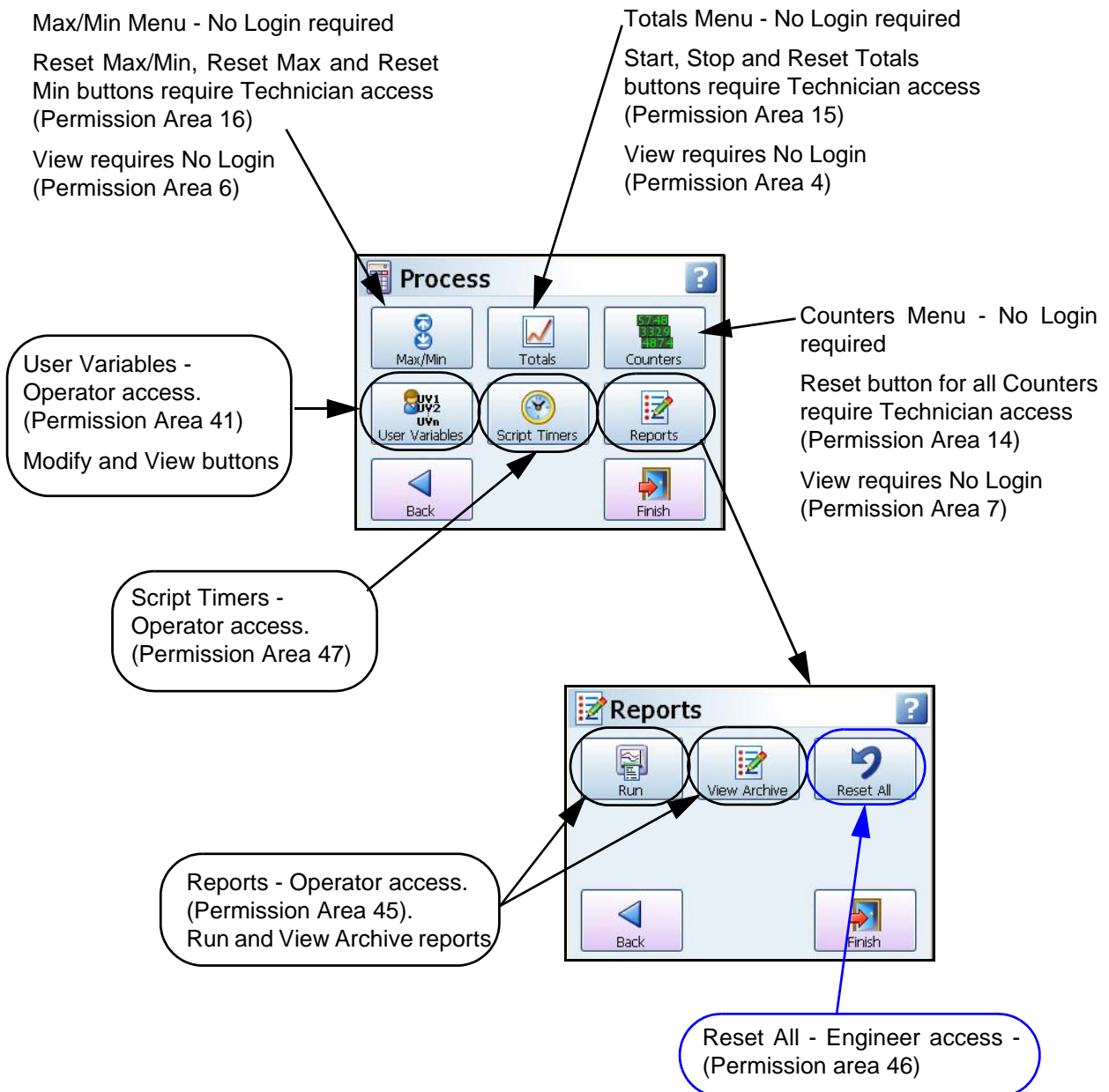

Figure 5.9 Default password access from the General Menu



General Menu - Supervisor access (Permission Area 20)

Ident, Error Alert and Factory require Engineer access. (Permission Area 28)

Batch requires Supervisor access (Permission Area 22)

Printer requires Supervisor access (Permission Area 21)

Groups require Supervisor access (Permission Area 26)

Factory menu requires Engineer access. All of the factory menu buttons require Engineer access. (Permission Area 28)



Figure 5.10 Default password access from the Messages Menu

Messages Menu - No Login Required

Except to clear the messages from each area requires Engineer access

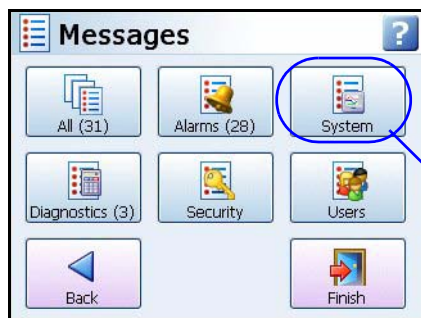

All messages screen have a button to clear (remove) the existing messages stored in the recorder for that particular area of messages. (Permission area 44)

| Type | Time | Date | Message |
|------|----------|------------|---------------------------------|
| ⚠ | 16:19:18 | 08/06/2007 | Scheduled export failed - no me |
| ⚠ | 16:19:03 | 08/06/2007 | Power On, Off for 0m:39s |
| ⚠ | 16:18:21 | 08/06/2007 | Setup Changed |
| ⚠ | 16:15:41 | 08/06/2007 | Scheduled export failed - no me |
| ⚠ | 16:15:26 | 08/06/2007 | Power On, Off for 0m:41s |
| ⚠ | 16:14:42 | 08/06/2007 | Setup Changed |
| ⚠ | 16:03:51 | 08/06/2007 | Scheduled export failed - no me |
| ⚠ | 16:03:36 | 08/06/2007 | Power On, Off for 0m:40s |
| ⚠ | 16:02:54 | 08/06/2007 | Setup Changed |
| ⚠ | 15:10:30 | 08/06/2007 | Failed to copy group 1 report_F |
| ⚠ | 15:03:12 | 08/06/2007 | Scheduled export failed - no me |
| ⚠ | 15:02:14 | 08/06/2007 | Setup Changed |

Figure 5.11 Default password access from the Comms Menu

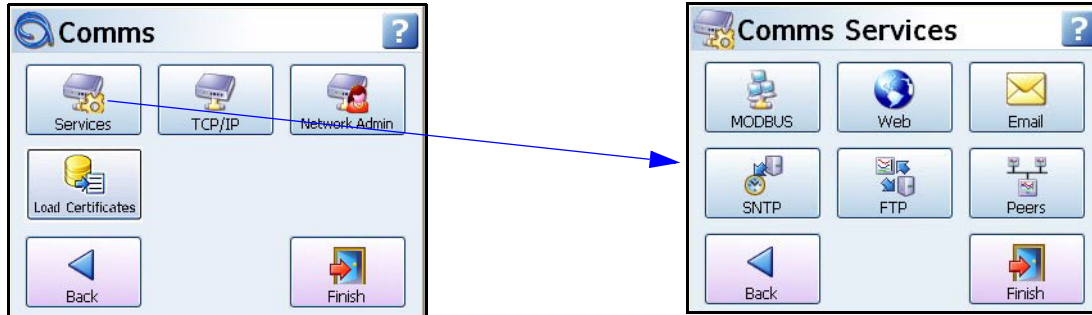

Comms Menu - Engineer access (Permission Area 29)

- Services - Permission Area 29
- TCP/IP - Permission Area 33
- Network Admin - Permission Area 29
- Load Certificates - Permission Area 29

Comms Services - Engineer access (Permission Area 29)

- Modbus - Permission Area 30
- Web - Permission Area 31
- Email - Permission Area 34
- SNTP - Permission Area 32
- FTP - Permission Area 31
- Peers - Permission Area 29

Figure 5.12 Default password access from the Web page

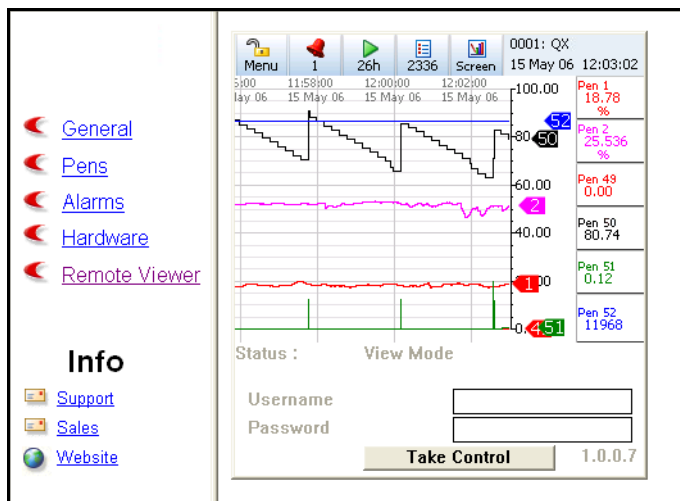

Web page - Engineer access

- View Status - Permission Area 37
- Full Control - Permission Area 39

Figure 5.13 Default password access to clear a pop up Alert

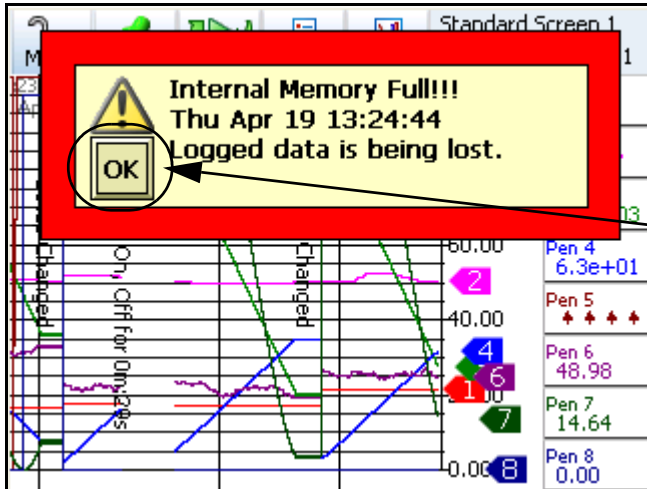

Clear Pop up Alert - Technician access

To OK or clear the error alert message Technician permission level is required (Permission area 42)

Figure 5.14 Default password access to use the Context menu

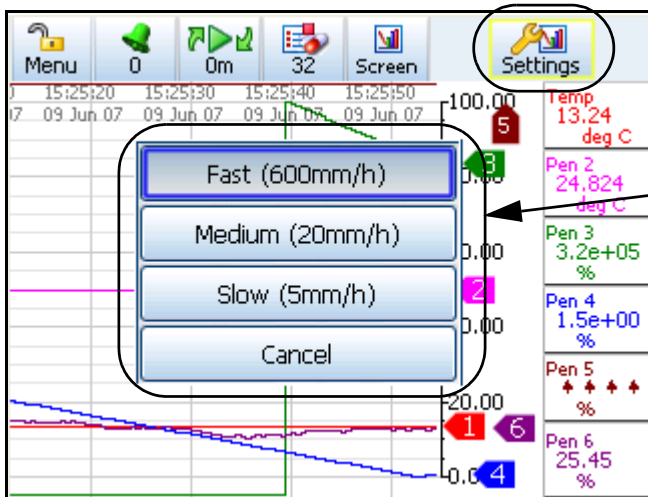

Context menu - Technician access

Touch any chart process screen to produce the Settings button in the top right of the screen. Select the Settings button to change the chart speeds. (Permission Area 43)

Hardware Configuration Lock

The Hardware Configuration Lock feature is located on the Processor board and works in conjunction with the Credit function to prevent any configuration changes once the configuration switch has been set to the "unlocked" position. See ["Options" on page 196](#). With the credit function active, the switch must be set to the "unlock" position to make configuration changes.

By default the configuration will not be locked. Only in case of regulatory requirements the factory can lock by adding the cap (JP2) on this connector. It can be locked simply by a small plastic cap placed on the JP2 link which will short the jumper in the hardware, which in turn is sensed by Firmware and it will lock the recorder configuration.

The lock can be easily accessed just by removing the back panel and simply adding (to lock) or removing (to unlock) this cap (link) from the board. [Figure 5.15 on page 224](#) shows the Processor board, with the Hardware Lock in a red box. This is simple two pin jumper (Connector /Header) designated as "JP2" on board. This operation should be performed by authorized personal.

The JP2 lock/unlock on the Processor board is the same for the **Minitrend GR, Multi-trend GR and the DR Graphic** recorders.

Figure 5.15 Hardware Configuration Lock / Processor board

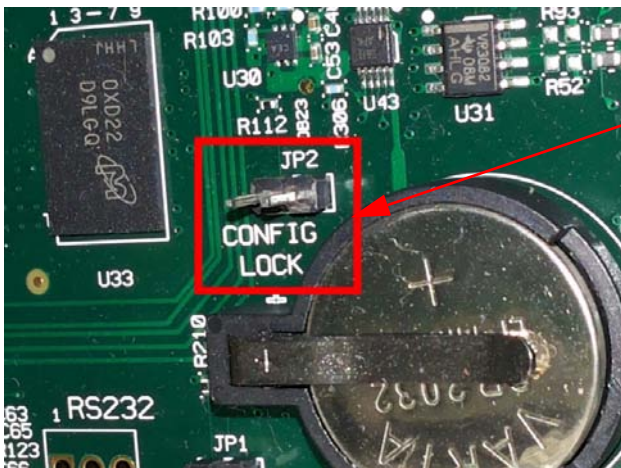

Unlock - JP2 has the plastic cap (link) removed



Hardware Lock location on Processor board. Unlock/removal of link (JP2) should be performed by an authorized person

Section 6: Screen Configuration

Process Screen Overview

Figure 6.1 Minitrend GR Process Screen

Standard Screen example - Chart and DPM

Recording menu allows:

- stop/start recording
- immediate download of recorded data

Message List icon allows quick access to Batches, Batch Detail, User Mark on Chart, and Messages

Select Options for Group 3

This grey area will appear if you are viewing a batch related screen

View Alarms

Alarm Status/Configure. Individual Alarm Acknowledge

Acknowledge all Alarms

Print or Save screen

Modify screen layouts

Replay chart history

List of available screens

View available screens

Enter recorder Setup menu

Recorder ID No. & Name (alternates to display the Screen Name)

Time and Date

Chart Area

Realtime Pen Pointers

Pen Digital Read-out

Yellow area shows when Pen 1 was in alarm state

Alarm Marker marks the chart to show when Pen 1 was out of its alarm state

Touch the screen to activate a short cut to Settings such as change the chart speed

| Pen | Value |
|-------|--------|
| Pen 1 | 81.26 |
| Pen 2 | 69.00 |
| Pen 3 | 26.00 |
| Pen 4 | 41.47 |
| Pen 5 | 37.50 |
| Pen 6 | 34.55 |
| Pen 7 | 47.74 |
| Pen 8 | 100.00 |

Menu Bar

At the top of each process screen is the Menu bar.

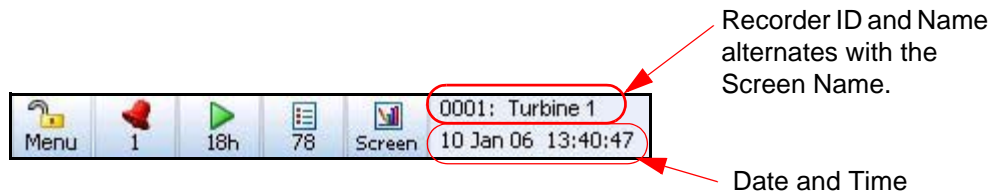

Menu

This gives direct access to the Menu System to set up the recorder. See [“Section 4: Recorder Setup” on page 63](#)

Alarm bell (1)

The second button shows the Alarm status. When the alarm bell is green this means there are no active alarms. If the bell is red then an alarm is active and the number of active alarms will display below.

Press this button to produce the Alarm menu bar. Here there is an Acknowledge button to confirm any latched alarms that require acknowledgment. See [“Alarms Menu” on page 88](#) There is a View button that displays all pens currently with alarms set up. The Detail button will take you straight to the Alarms menu, see [“Alarms Menu” on page 175](#)

Time Left (18h)

This button shows how much time is left before data will fill the internal memory and an export of the memory to an external device is required, before data is overwritten. Select this button to go to the Recording screen to export the data now or set up a timed export using the Scheduled option. See [“Recording Menu” on page 184](#)



If the Time Left button shows two green arrows this means that the memory buffer is full and the oldest data has started to be over-written.

List (78)

This button produces another button bar for quick access to Batch Controls, Batch Detail, Mark on Chart or Message details. The number displayed is the number of new messages that have been registered since the menu was last checked.

Select this to produce another button bar with access to:

- **Batches** - Shortcut to enter details to start a new batch or to control a batch that has already been started. See [“Batch Setup/ Batch Groups” on page 180](#)
- **Detail** - Gives detail of the current batch status for all batches running. If you are displaying a screen that has been set up specifically to show a batch then the details will be just for that batch.
- **Mark on Chart** - Select the Mark button to enter a Mark on Chart. Embedded process values can be entered which will display pen information on the marker. See [“Embedded Process Values” on page 119.](#)

- **Message Detail** - Press this button for quick access to the Messages screen, where each message is put into a category or All Messages can be viewed. [See “Messages Menu” on page 187](#)
- **Exit** - To return to the process screen

Screen

The Screen button produces the Screen menu bar.

Figure 6.2 Screen Menu bar

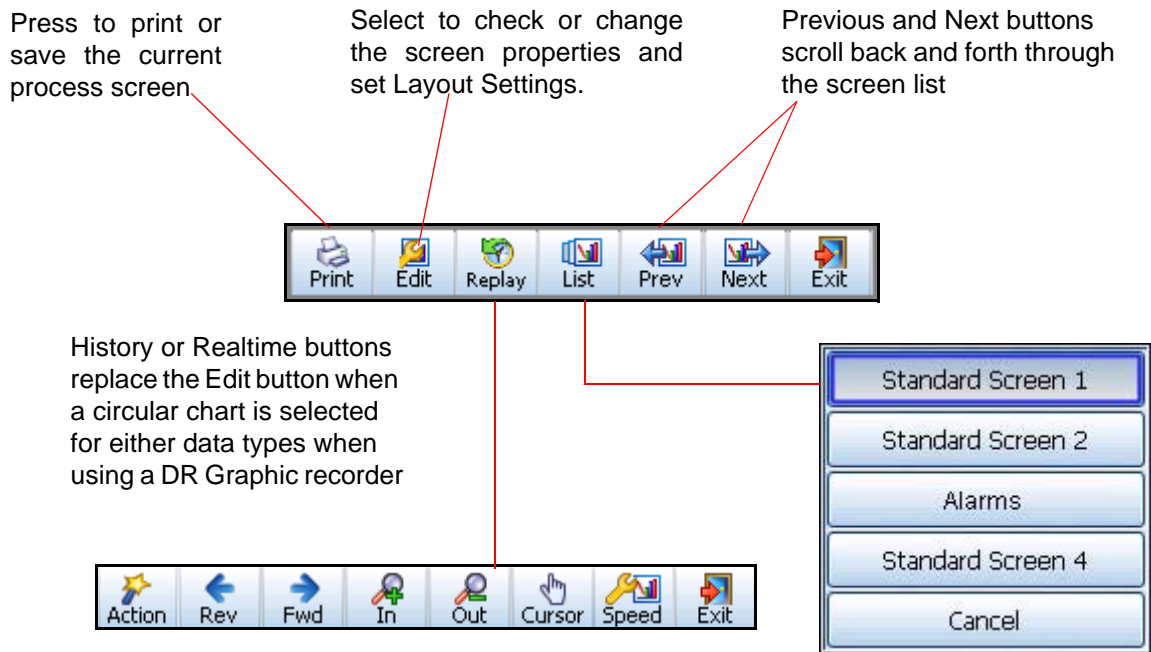

Screen Menu Bar

- **Print** - Instantly prints the screen you are displaying. To set up your printer, see [“Printer Menu” on page 141](#). Every pixel is sent to the printer!. Save a screen shot of the current displayed screen to external removable media.
- **Edit** - From a standard process screen this gives quick access to Screens, Settings and Appearance. View all available Screens and modify certain screen properties including Screen name, Template Type, Orientation and Pens being displayed. [See “Edit Layout” on page 157](#) for details. Use Settings to set up screens for cycling. Cycling screens will display specific screens for an allocated amount of time before switching to the next. When the **DR Graphic** recorder has a circular chart selected the Edit button is replaced with History or Realtime buttons depending on the type of data being shown. The Edit button is still available in circular mode from the Main menu>Configure>Layout
For Custom Screens this will enable the Edit tool bar, go to the [“Edit Toolbar” on page 176](#). This is for Pen/Channel mapping and Expert mode for moving and resizing items on the screen.

- **Replay** - Gives quick access to the Replay Screen and the Replay toolbar. [See "Replay" on page 228](#)
- **List** - List of all available screens, select to change the current screen.
- **Prev** - Displays the previous enabled screen in current selection
- **Next** - Displays the next enabled screen in current selection
- **Exit** - Exit this menu, return to the current process screen

Replay

The Replay button takes you to the process screen in replay mode. The replay screen consists of a chart and DPMs. For standard screens the replay chart is vertical or horizontal depending on the orientation of the screen you have come from. The replay screen has DPMs that display max/min readings for each pen, these values are taken from where the cursor is positioned on the screen. Use the print button on the replay bar to print the replay screen.

DR Graphic History Mode in Circular Chart Mode

The top status control has been modified for Circular Chart screen to include the ability to go back and view the previous chart. This item is available by selecting the top status bar screen button. The 'Edit' button is overridden in the event that the current screen is showing a circular chart. The Edit facility is still available from the Main Menu -> Configure -> Layout. The status bar toggles the button depending on whether real-time or historical data is being shown:

The top screenshot shows the 'History screen in realtime' mode. The toolbar includes buttons for Print, Realtime, Replay, List, Prev, Next, and Exit. The 'Replay' button is highlighted with a red box. The data table on the right shows values for Pen 1 through Pen 4, all at 0%.

| | |
|-------|----|
| Pen 1 | 0% |
| Pen 2 | 0% |
| Pen 3 | 0% |
| Pen 4 | 0% |

The bottom screenshot shows the 'History screen in replay' mode. The toolbar includes buttons for Print, History, Replay, List, Prev, Next, and Exit. The 'History' button is highlighted with a red box. The data table on the right shows values for Pen 1 through Pen 8.

| | | |
|-------|-------|---|
| Pen 1 | 49.91 | % |
| Pen 2 | 49.91 | % |
| Pen 3 | 49.91 | % |
| Pen 4 | 49.91 | % |
| Pen 5 | 50.00 | % |
| Pen 6 | 50.00 | % |
| Pen 7 | 50.00 | % |
| Pen 8 | 50.00 | % |

Cursor

On the right hand side of the replay screen DPMs can display max/min readings for each pen, these values are taken from where the cursor is positioned on the screen.

Note: You can do replay on Bar, Charts and Digital Panel Meter process screens and this will jump into a trend replay screen with the DPM's showing the Min-Max values.

When using Custom Screens you can only replay 8 pens on the **Minitrend GR and DR Graphic** and 18 pens on the **Multitrend GR** recorder even though you can have more pens than this on the custom screen. (Custom Screens are not available on the **eZtrend GR**).

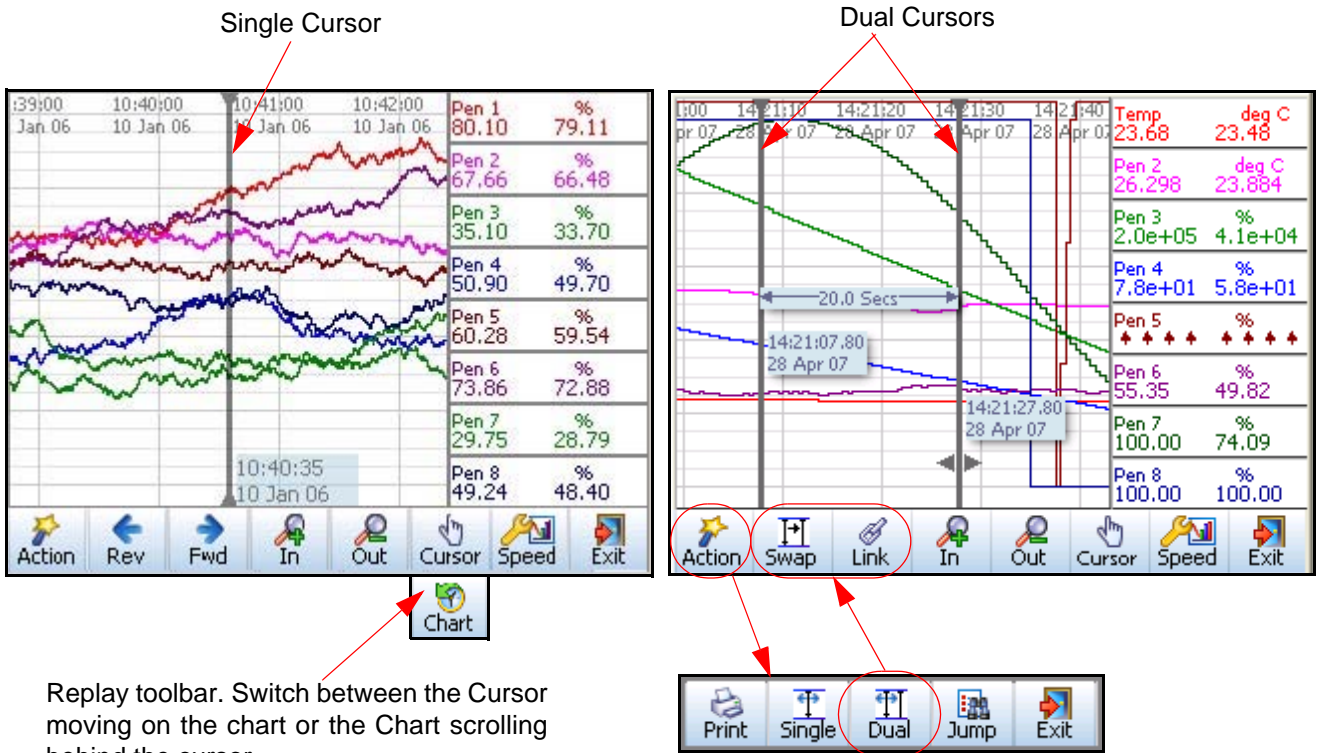

The Action button produces the Action toolbar. The Dual button will change the icons on the replay tool bar to enable you to swap between cursors and/or link them together.

Replay Toolbar

The Replay toolbar will appear at the bottom of the screen

- **Action** - See "Action Toolbar" on page 230.
- **Rev** – This is used to scroll back through previous data. Touch once to scroll back in increments or hold the Rev button down to continue backwards viewing of data.
- **Fwd** – This is to scroll forwards on the chart. Touch once to scroll back in increments or hold the Rev button down to continue backwards viewing of data.
- **In** – Zoom In on the chart being displayed. Place the chart cursor at the point you wish to zoom in to. Zooming In will magnify the chart to show greater detail around the cursor position.

- **Out** – Zoom Out on the chart being displayed. Place the cursor at the point you wish to zoom out from. Zooming Out will decrease the chart to show a larger time span around the cursor position.
- **Cursor/Chart** – In Cursor mode the cursor bar can be moved along the chart showing the max/min pen readings as they change and are displayed on the DPMs. This can be done by touching the line cursor on the screen and dragging it to either side. In Chart mode the chart can be moved along behind the cursor bar. The DPMs will update reflecting the max and min readings at the position of the cursor bar. This can be done by touching the chart on the screen and dragging it to either side or by using a mouse. See [Figure 6.3 on page 229](#).
- **Speed** - set a Fast, Medium or Slow chart speed in replay mode. Select the Speed button and three chart speeds will appear for the replay scree; Fast (10x), Medium (3x) and Slow speed (0), which is normal speed
- **Exit** - to return to the previous process screen.

Action Toolbar

The Action toolbar can be set to timeout (disappear) after a specified time. To set the time see Menu bar TO, [“Settings” on page 160](#).

- **Print** - This will print the current replay screen. For network printers ensure all printer/server information has been entered in [“Network Admin” on page 98](#).
- **Single** - This is for a single cursor to be displayed on the replay screen.

- **Dual** - This is a mode that displays an additional cursor showing the time difference between the two. When selected the toolbar icons will change to Swap and Link. The two cursors appear on top of each other and can be moved by dragging one of the cursors using the stylus on the touch screen. The cursor with the two grey arrows is the movable one, to change this use the Swap button. Each cursor can be positioned independently and linked so they can be moved together; use the Link button. Each cursor will also show its current time/date and the digital readings on the right hand side show the max and min between the cursors as opposed to under a single cursor. See [Figure 6.3 on page 229](#).

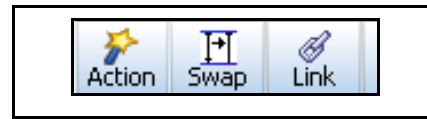

- **Jump** - This is a Message jump mode that allows the user to jump to the next or previous message on the chart, the display will centre on the message in question. Select Jump and the toolbar buttons will change to Prev(ious) and Next. Use these to jump to the previous or next message on the screen. See [Figure 6.3 on page 229](#).



- **Exit** - to return to the Replay screen

Messages List links to Replay Screen

To locate the time of an occurrence on a chart you can select an item in any of the message lists and press the Jump button. This will take you to the exact time of the occurrence on the replay screen.

If the message requested is older than the oldest chart time/data available a message box will appear and jump you to the oldest chart time and date available.

Hide Pens

When in replay mode all pens are initially displayed to allow for better analysis. Pens in replay can be quickly turned off leaving just the pens you want to analyse, by pressing the digital panel for a pen the trace will be removed off the chart and the digital panel will go dark grey (but still showing the pen name). Press the digital panel of a removed pen to reinstate. At least one pen must remain on the replay screen and any pens removed will be reinstated after exiting replay.



In the Replay screen the traces for pens 5 and 8 have been hidden to allow for viewing. Touch the DPM on the screen to toggle the pen trace On and Off

About Replay

The replay screen facility enables the user to:

- Show greater coverage of elapsed time (display more history)
- Zoom in and out further
- Display data on a chart and DPM screen
- Display Max Min readings on DPMs
- Display pens on a chart replay screen that are currently displayed on a DPM screen
- Add any enabled pen on to a process screen. All enabled pens have history, even if not displayed on a process screen. These can be added onto a process screen at any time to view and replay data.
- There is a Replay Screen time-out feature so if the recorder is in replay mode and there has not been any user activity for a defined amount of time then the replay screen will return to the process screen. [See "Settings" on page 160.](#)

Replay and Hot Buttons

If any Hot Buttons have been configured to "Enter Replay Screen", then when the equivalent Hot Button is selected (eg.HB1), in a Process screen, the Replay screen will be started. This does not apply to Non-Process screens. The Hot buttons will appear in the top right of the screen but will not activate on a non-process screen.

Hot Buttons on Process Screen

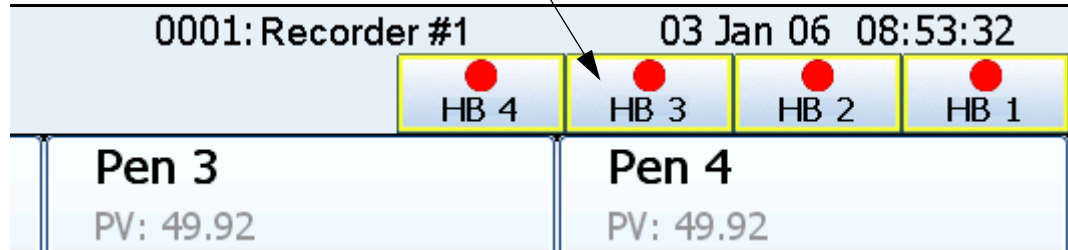

Zooming

When the recorder switches to the replay screen it will represent the chart speed that is on your current process screen, (the one you've just left). This will affect how far you can zoom in and out. For example if you are using the Medium chart speed (what ever it may be set to) the screen can zoom in 5 more times to see detail over a shorter time span and can zoom out a further 4 times to view more data over a longer period of time.

The amount of data displayed on the replay screen is dependant on what chart speed is selected and how many pens are enabled in the recorder.

Chart/Logged data Slider

An adjustable slider shows how much memory is allocated to Chart data and how much memory is allocated to Logged data. The user can adjust the slider which will display how long it will take to fill the memory, at the current chart speed, before the data will start to be recycled. See ["Storage Bias" on page 149](#)

How Replay works

There are three separate “queues” of data, represented by the three different chart speeds. As you zoom in and out it switches between these different “queues”.

These “queues” are not all the same length, so for example:

- The fast speed at 600mm/hr means to cover 24 hours takes approx. 30Mbytes for 8 pens.
- The medium speed at 20mm/hr means that to cover 24 hours takes 1Mbyte (1/30 of fast).
- The Slow speed at 1mm/hr means that to cover 24 hours takes 50Kbyte (1/20 of Medium).

The result of this is that the slow speed will tend to give you much more elapsed time history, but at a lower time resolution, here is a representation of what this could look like.

| Data | | | | |
|--------|------------|--------------|---------|------------|
| 2 week | 4 weeks | 6 weeks | 8 weeks | 12 weeks |
| | Fast speed | Medium speed | ! | Slow speed |
| | | | | |
| | | | | |
| | | | | |
| | | | | |

The lines represent absolute time coverage. So if you go right back to the earliest time on the slowest chart (shown by '!' in this example), you cannot zoom in any more as the medium speed coverage does not go back that far.

Zooming Capabilities

The example in [Figure 6.4 on page 234](#), shows 10 different replay screens covering the full zoom in/zoom out capabilities. When the screen is switched to replay the chart speed is set to Fast (600mm/hr) and the replay screen displays a 4 hour chart. The replay chart can be zoomed out two more times to 10 hours, then to 12 hours. It can be zoomed in from 4 hours to 2hrs, 1hr, 1hr (with bigger divisions), 20 mins, 10 mins, 5 mins, 2 mins and 1 min. The Medium chart speed (20mm/hr and the Slow chart speed (5mm/hr) are also shown in the example.

Figure 6.4 Zooming on a Replay screen

12 hour/div
replay chart

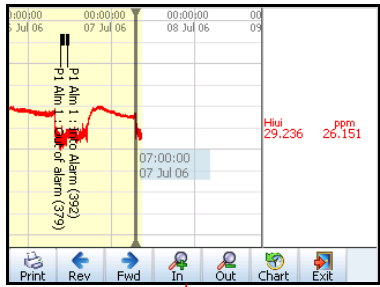

10 hour/div
replay chart



4 hour/div
replay chart

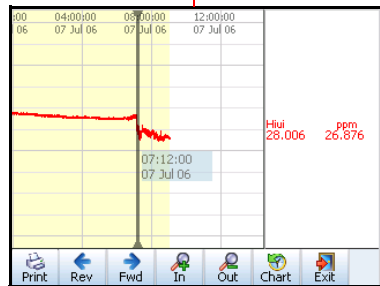

Fast chart
speed
(600mm/hr)

2 hour/div
replay chart



1 hour/div
replay chart

Medium
chart
speed
(20mm/hr)



1 hour/div
replay chart
(bigger
divisions)

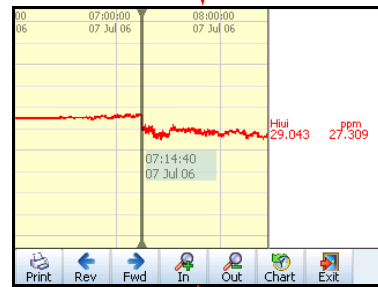

10 mins/div
replay chart

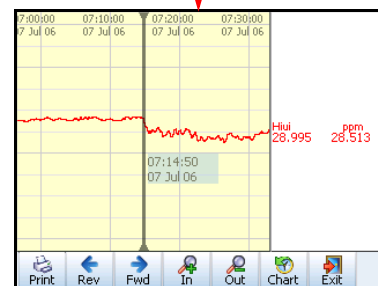

5 mins/div
replay chart



2 mins/div
replay chart



Slow chart
speed
(5mm/hr)

1 min/div
replay chart



Zoom In
Zoom Out

Chart Speeds

This is the speed at which the chart travels across the screen (not replay mode). There are three categories; Slow, Medium and Fast (default) chart speeds that can be set up in [“Charts” on page 144](#).

To change the chart speed gently tap the touch screen on a chart to activate the Settings button in the top right of the screen. Press the Settings button to produce a drop down list of the 3 chart speed categories. Select the desired speed and this will immediately change the chart speed on all screens that have charts. The Settings button will auto hide in 4 seconds, touch the chart again to activate.

To change the chart speed from Slow, Medium or Fast, return to a process screen with a chart and touch the chart. This will produce the Settings button in the top right of the screen, select this to display the current chart speeds setting for Fast, Medium and Slow. The current selection will be highlighted. To change the actual chart speed setting for Fast, Medium and Slow, see [“Charts” on page 144](#).

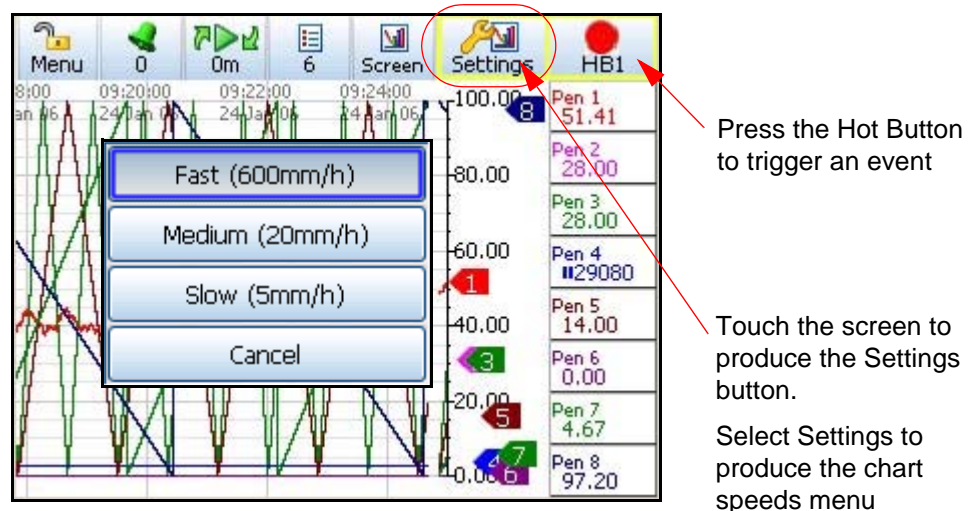

QuickView

Changing chart speeds can be used as quick view of the data at different resolutions.

Hot Button

This function is disabled by default. To enable the Hot Button go to [“Settings” on page 160](#). The hot button has a customizable caption (name) up to max 7 characters.

The Hot Button function, when active as an Event cause, enables the user to select the Hot Button on the active screen and the corresponding event (that the user needs to set) will be triggered. The **Multitrend GR** and **DR Graphic** supports 4 hot buttons, **Minitrend GR** supports 2 hot buttons, **eZtrend GR** supports 1 hot button. If enabled, hot buttons will always be visible on the top status bar at right corner below recorder name and date time labels.

To set up a Hot Button as an Event cause go User Action sub menu in [“Event Causes” on page 115](#). After setting up the event cause user can set up event effect. See [“Event Effects” on page 119](#).

Screen Activity

Alarm Markers



Alarm markers appear when an alarm is setup in the Pen Alarms menu. Hi and Low alarm markers appear as a triangle on a DPM or Bar, pointing up for a Hi alarm and down for a Low alarm. [See “Alarms Menu” on page 88](#)

Deviation Alarm Markers



These are diamond shape markers. Deviation is how far this pen can deviate from the Ref Pen before triggering an alarm.

[See “Alarms Menu” on page 88](#) to set up the alarm Type, Deviation Level and the Ref Pen.

Rate of Change Alarm Markers







There are two types of rate of Change Alarms; Rate Up and Rate Down. They will appear on a DPM or Bar when a Rate Up or Rate Down type alarm has been set up in the [“Alarms Menu” on page 88](#) and has been triggered. The Rate Up Alarm Marker will slope up to the right and the Rate Down Alarm Marker will slope down to the right.

Alarm Marker Flash Colours

For Hi, Low and Deviation alarms.

Table 6.1 :

| | Alarm Markers Flash Colour | |
|---|----------------------------|---|
|  | Magenta flash | In alarm not acknowledged |
|  | Yellow flash | In alarm acknowledged, latched alarm |
|  | Cyan (blue) flash | Out of alarm (latched) not acknowledged |
|  | Grey | Out of Alarm |

Pen Pointers

Pen Pointers appear on a scale next to a chart when no bars are present. They move to display the real-time value. Each pen pointer is numbered according to its associated pen and will flash yellow when that pen goes into an alarm state. Pen pointers will change direction and point up or down when a pen signal goes off scale.

Mark on Chart

There are two different types of Mark on Chart, automated or user. An automated Mark on Chart can be set up for:

- An Alarm going in and out of an alarm state,
- Start, Stop or Reset Totals
- Batch control such as Start, Stop, Pause, Resume and Abort batch.
- Generated by an effect of an Event

A user Mark on Chart is activated by first selecting a process screen that is displaying a chart. Go to the Messages List button on the Main Menu bar and select Mark. A text box will appear, enter the message you wish to be displayed as a mark on chart on the screen using the on-screen keyboard or a USB keyboard.

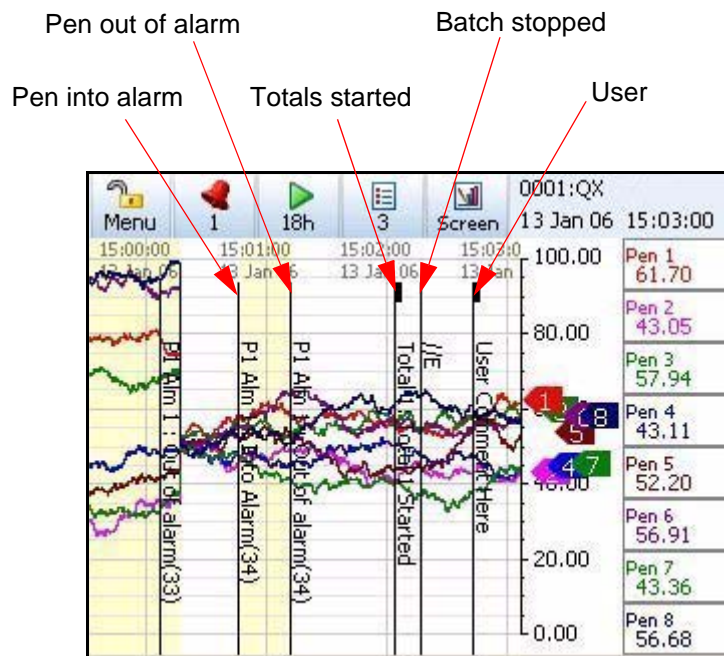

Figure 6.5 Mark on Chart

Screen Markers

Table 6.2, "Screen Markers," on page 238 shows different types of markers that may appear on the screen during normal data activity and where they would appear.

The markers change depending on if the signal goes High or Low, outside the Pen Scale, or outside the Input Range.

Note: It is recommended to display DPMs on a chart to identify over-range and under-range activity.

Table 6.2 : Screen Markers

| | DPM | Bar | Pointer (horizontal chart) | Chart | |
|--------------------|----------|---------|----------------------------------|--------------|------------|
| Upscale Burnout | | | | | Valid Data |
| Outside Range High | | | | Trace at Max | |
| Input Range Top | ----- | ----- | ----- | ----- | |
| Pen Scale Top | 1234.567 | | | Trace at Max | |
| Pen Scale Bottom | ----- | ----- | ----- | ----- | |
| Displays as normal | 1234.567 | Bar | | Trace | |
| Pen Scale Bottom | ----- | ----- | ----- | ----- | |
| Input Range Bottom | 1234.567 | | | Trace at Min | |
| Outside Range Low | | | | Trace at Min | |
| Down scale Burnout | | | | | |
| Invalid Reading | **** | **** | | Trace at Min | |

Screen Designer Screens

(not available on the **eZtrend GR**).

Screen Designer screens, known as Layouts (file type .lay) can be created in the Screen Designer software on your PC and then loaded onto the recorder. This can be done via SD card, USB or Network Share folder (NAS) transfer. Templates created in Screen Designer can also be loaded into the recorder, added to a recorder screen or screens and displayed. Refer to the Screen Designer manual for further details.

For layouts to be loaded into the recorder Custom Screens must be enabled as a Firmware option. See [“Section 7: Firmware Options” on page 241](#).

It is recommended to save Screen Designer layouts directly from the software onto a SD card, USB key or to a Network Share folder (NAS). This will contain all the files required for loading the layout into the recorder. If the Screen Designer layout is saved to another location before being transferred onto removable media, ensure that both the .bcf and .lay files are copied over. A warning message will appear if the .bcf file is missing.

Loading a Template into a Recorder

One or more Templates can be loaded into a recorder, added to a recorder screen or screens and displayed. To save a template in Screen Designer onto removable media refer to the Screen Designer manual.

Fit the removable media into the recorder and go to *Main Menu > Configure > Layout* and select Load. The Device selection menu will appear to select the correct media. Enter a new file name if required and press the Load button.

Go to *Main Menu > Configure > Layout > Edit* and select Add Screen. Go to the Template Type option and your template will be listed here. Select either **GR Series** or **X Series** recorders and then the recorder type: **Minitrend/QX/GR, Multitrend/SX/GR/DR Graphic**. Select your template and it will be added to a screen, re-name the screen as required.

To display the new Layout go to the Screen button in the Main menu bar at the top of any process screen and select the next button to scroll through the screens.

Loading a Layout into a Recorder

One or more Layouts can be loaded into a Recorder and displayed. To save a Layout in Screen Designer onto removable media refer to the Screen Designer manual.

Fit the removable media into the recorder and go to *Main Menu > Configure > Layout* and select Load. The Device selection menu will appear to select the correct media. Select the desired layout and press the Load button.

Go to *Main Menu > Configure > Layout > Edit* and the new layout will be loaded into the list of Screens. If the Custom Screens option is disabled in the credit system the screens will not display.

To display the new Layout go to the Screen button in the Main menu bar at the top of any process screen and select the next button to scroll through the screens.

Note: When importing **X-Series** layout files to use on **GR Series**, certain changes must be made to the layout file, by the user, as per the new resolution and vice-a-versa for **GR Series** layout files being used on **X Series** recorder. [Table 6.3 on page 240](#). Changes are required for Custom Screens for the GR Series for this Screen Designer should be used.

Table 6.3 :

| X-Series Screen Resolution | | GR Series Screen Resolution | |
|----------------------------|-----------|-----------------------------|------------|
| eZtrend QXe | 320 x 240 | eZtrend GR | 320 x 240 |
| Minitrend QX | 320 x 240 | Minitrend GR | 640 x 480 |
| Multitrend SX | 800 x 600 | Multitrend GR | 1024 x 768 |

Note: Non Process Screens are not supported in Screen Designer.

Bitmaps

Bitmaps can be inserted into a layout in Screen Designer and then loaded into the recorder just like any other layout (.lay).

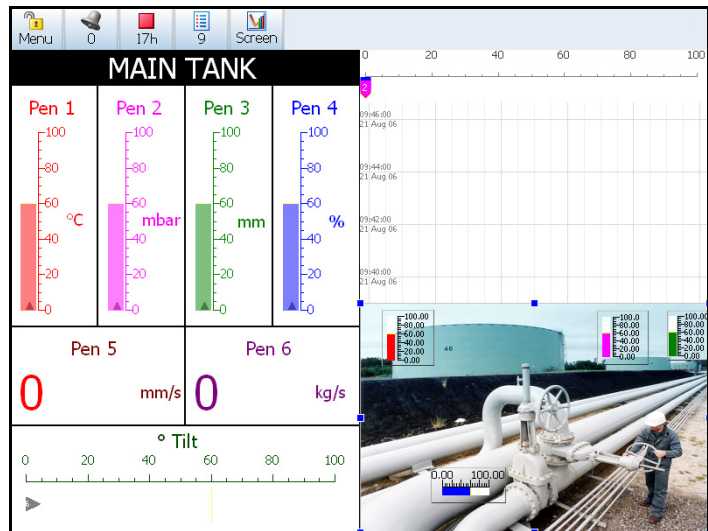
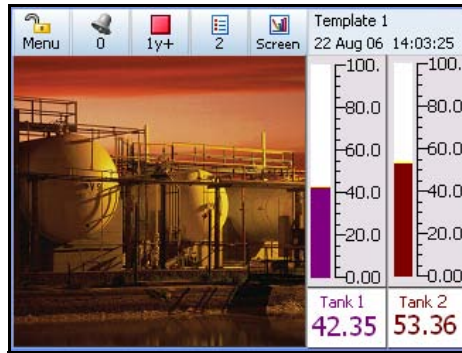

Section 7: Firmware Options

Firmware Credit System

The credits system is a flexible way of changing the recorder features without having to upgrade the firmware. Simply purchase a number of credits to cover your current and possibly future requirements and the recorder is delivered with the credits loaded. The credit value in each recorder is displayed in the Factory menu.

Select the Options button and by activating and de-activating the options in the credit list, the recorder will change its functionality. Go from: *Main Menu > Configure > Setup > Edit > General > Factory > Credits.*

Table 7.1 : Firmware Options

| Firmware option | Credit value | Description |
|---|--------------|---|
| Full Maths* (Note 1) | 4 | Full Maths - this can handle math expressions that can consist of expressions up to 100-characters in length. |
| Full Maths with Scripting* (Notes 1&4) | 6 | A powerful multi-line scripting ability available to solve complex state based applications. Eg. building an application for: "If .. X happens, then Y will happen, else .. Z will occur. |
| Events (Note 3) | 6 | Events are certain conditions or operations that can be set up and logged according to the time and date of an occurrence. Subsequently events can be reviewed or displayed on a graph. The Event Causes currently include: Alarms - Into/Out of and Alarm Ack, Totals - Start/Stop/Reset/Reset and Start, Digital Input - ON/OFF/State Change, T/C Burnout, Scheduled - Once/Interval/Specific Days/Month End, User Counters, Max/Mins - Reset, System - Power ON/Setup Change/Internal Memory Low/Export Memory Low/FTP Memory Low, User Action - Mark Chart, Batch - Start/Stop/Pause. The Event Effects currently include: Mark Chart, Logging - Start/Stop, Totaliser - Start/Stop/Reset/Reset & Start, Digital Output - ON/OFF, Alarm Acknowledge - Single pen/Pen group/All pens, Emails, Screen Change, Print Screen, Counters - Reset/Increment, Max/Min (Reset), Chart Control-Pause/Stop/Resume/Clear/Prefill, Clear All Messages, Delayed Event, Script Timers - Start/Stop/Reset/Reset & Start, Play Sound - Start/Stop, Display Alert, Reports, Batch - Start/Stop/Pause. |
| Fast Scanning mode (Note 4) | 5 | For fast processes, the scan rate and recording of the data can be set for up to 50 times per second (20ms) for up to 8 inputs for the Minitrend GR & DR Graphic and 8 inputs for the Multi-trend GR . |
| Totalisers/ Sterilisation calculation (Note 1) | 4 | Each pen can be associated with a totaliser. Using extra pens, the totalised values can be displayed and recorded; multiple totals can be calculated out of the same variable (weekly, monthly, etc.). The totaliser function can handle Fo and Po sterilisation calculation. |
| Custom Screens (Note 2) | 4 | Import custom built screens that have been created in Screen Designer. |
| Reports | 3 | Generate reports manually or using the event system to show daily/weekly/monthly Totals, Max/Mins, Averages, Current Value. Messages, Message Lists - Alarm, System, Diagnostic, Security & User, Counters, Digital Inputs, and Digital Outputs. Reports can be printed, e-mailed as an attachment or exported to external media in RTF format. |
| AMS2750 Process | 5 | AMS2750 Process activates the Process Mode screen and the AMS2750 process configuration menus for furnaces and sensors in accordance with AMS2750 specification, including Thermocouple tracking. |
| Health Watch/ Maintenance | 2 | The recorder keeps track of important "life actions" for improved diagnostics and preventative maintenance notification. Including Power cycles, Last powered up, Total On time, Total Off time, Longest off time, Battery life left, Backlight life left at 100% brightness, SD Card insertions, Hi/Lo CJC value (Hi & Lo temps), Analogue In last factory/user cal, Relay operations. |
| Print Support | 2 | Enables the printer option to print text from various screens using a standard PCL (Printer Command Language) printer, connected to the USB 2.0 port or to the network |

Firmware Credit System

Table 7.1 : Firmware Options

| Firmware option | Credit value | Description |
|----------------------------|--------------|--|
| AMS2750 TUS | 10 | AMS2750 TUS activates the TUS screen and the AMS2750 TUS configuration menus for furnaces and sensors in accordance with AMS2750 specification, including Thermocouple tracking. All of the survey information can be exported to a Report Generating tool. Multitrend GR and DR Graphic only |
| Batch/Groups | 5 | The Batch function allows the user to segment portions of data for further analysis. The Batch function manages sections of data. Concurrent batches are now associated with a group of pens. The pens with in each group will belong to the batch that is controlled by that group. Batches can be controlled through the event system and batch markers are setup by the user and are used to identify and analyse batches of data. Supports up to 6 concurrent batches. |
| Counters | 3 | User Counters can be set up and used as a part of the Events system to count an occurrence. Other counters are available depending on hardware availability. Eg. Alarm, Event, Digital Input, Relay Output and Pulse counters. |
| Modbus Master | 10 | Modbus master enables the recorder to communicate with up to 32 Slave devices on both Ethernet and RS485. The recorder itself can also act as a slave device while also being a master. RS485 is not available for eZtrend GR . |
| Remote Viewer | 3 | Extends the user interface of the recorder onto the desktop PC. Providing full remote control of the recorder launched from a web browser. |
| Email | 3 | Setup email accounts to send the following: When an Alarm is triggered or an Email can be sent as a part of an Event occurring, such as: Alarms - In/Out/Ack , Totaliser – Start, Stop or Reset, Digital Inputs – On, Off or State change, TC Burnout – on a specific Analogue Input channel, Scheduled Events – Once, Interval, Specific days, Month End. |
| Pwd Net Sync | 5 | Password Network Synchronisation. Password can be synchronised over the network, a recorder can be designated as a master of a password group and other recorders can be added to that group as slaves, the master will ensure all passwords are synchronised with all recorders in its group. |
| Secure Comms | 3 | Secure Comms (WSD) is a web service that can run on devices and conforms to the Devices Profile for Web Services (DPWS). Recorder device will host web service and have server certificate installed on it. Desktop clients will have root authority certificate of server in trusted root certificates. Whenever client connects to WSD service SSL handshake will take place and on successful handshaking secure communication channel will be established and data flowing between these two end points will be encrypted. |
| Extra Pens (4 pens) | 2 | 4 extra pens to store and display totalised values, results of calculations, etc. Maximum is up to 16 extra pens for the Minitrend GR , 12 extra pens for the eZtrend GR recorders, and 48 extra pens for the Multitrend GR and DR Graphic recorder. |
| Hardware Lock | 2 | Uses the password permission areas to lock access to the hardware configuration functionality leaving some areas view only. |
| Ext. SD | 5 | This feature is available only on the eZtrend GR . Access to external SD card for setup load/save or data export would be credit based. If the external SD credits are enabled than only user will be able to access external SD for tasks like setup load or save, data or report export. |

Notes for [Table 7.1 on page 241](#)

* Basic maths is standard in all recorders. Basic Maths math comprises of: Add, Subtract, Multiply and Divide

(1) Additional pens (“Extra Pens”) can be used to display and store the results of calculations, totalisers, variables imported via communications, or to store values.

(2) Custom Screens must be built using Screen Designer (.lay). Screens from V5 Screen Designer versions cannot be imported (.lyt). (not available for the eZtrend **GR**)

(3) Event markers are required to automatically reset the totalisers, for example on a periodic basis or on an external condition. (Not necessary if the totalisers are reset manually)

(4) Not available for the eZtrend **GR**

Firmware Credit System

Credits can be applied to the Firmware functions until the total number of credits purchased has been used up. See [“Applying your Firmware credits” on page 243](#).

Additional credits can be purchased later if new features are to be activated and not enough credits are available to support these additional functions

Firmware Options

Applying your Firmware credits

To activate the Firmware options follow this file path.

Main Menu > Configue > Setup > Edit > General > Factory > Credits

The Credit menu contains the Serial No. of the recorder, how may credits are available, displays the Options Code and lists what firmware Options are currently active.

- **Serial No.** - read only and cannot be edited.
- **Credits** - read only and cannot be edited. It displays the number of Credits available to activate additional firmware functionality including the total credit value.
- **Options Code** - the Options code is a unique coded number for this recorder that contains information that enables certain functionality including credit value.
- **Options - Select the Options button**
 - This displays how may credits are currently in use.
 - Select Options to produce a list of Firmware options available with their credit values. The number or credits required is shown in brackets.
 - Toggle each option On or Off to enable the feature within the recorder.
 - More credits are available from your supplier.

| Menu Item | Value |
|--------------|-------------------|
| Serial No. | 100089 |
| Credits | 30 |
| Options Code | 100089890302109 |
| Options | 28 Credits in Use |

| Option | Credits | Status |
|-----------------|------------|--------|
| Maths (4/6) | Full Maths | ▲ |
| Events (6) | | ✓ |
| Fast Scan (5) | | ✓ |
| Totals (4) | | ✗ |
| Custom Scrn (4) | | ✗ |
| Maintenance (2) | | ✓ |

Section 8: Communication

Comms Configuration

Once the recorder has been set up for Comms the **TrendServer** software and Communications Server requires configuring to allow the recorder to connect with your PC. To set up Comms in the recorder go to [“Comms Services Menu” on page 101](#). For Comms wiring details in the recorder see [“Communications Connections” on page 42](#).

Follow these stages for successful communications.

- Read about the different Comms interfaces used by the recorders. See [“Standard Communication Interfaces” on page 245](#).
- Set up your PC / Network connections. See [“Hardware Installation” on page 247](#).
- Configure the **TrendServer** software. See [“Comms and Trend Manager Suite” on page 251](#).
- Comms Server software set up. See [“Communications Server” on page 258](#).

Standard Communication Interfaces

Before we start here is some information about the comms interfaces that are used in the setup of the **TrendServer** software and Communications Server. **Minitrend GR, Multitrend GR, eZtrend GR and DR Graphic**

Rear Ethernet Communication port (inside the case for DR Graphic).

The rear of the device is fitted with an Ethernet 10/100 port, which supports:

- Modbus TCP/IP. See [“Modbus” on page 246](#).
- Web browser. See [“Web Browser” on page 276](#).

Rear RS485 port

For the **Minitrend GR** and the **Multitrend GR** and **DR Graphic** recorders RS485: 2 wire (half duplex) to support Modbus RTU is standard. See [“RS485 Minitrend GR, Multitrend GR and DR Graphic recorders.” on page 42](#). Not available for the **eZtrend GR**

Front and Rear USB Communication Ports (inside the case for DR Graphic)

USB communication ports can be found one at the front and one at the rear of the recorder. The **eZtrend GR** only has one USB (2.0) port at the front fitted as standard. 2 USB ports for the **DR Graphic** are extended inside the case to a dual panel mount receptor near power supply. USB peripherals/wires can be connected on the panel mount connector for the **DR Graphic** inside the case.

The USB Host ports will provide an interface for:

- Save and Load Data.
- Save and Load Setups.
- External keyboard & mouse
- Barcode reader
- Mass storage device (USB key) or Hard drives (250 GB)

USB Barcode Reader

USB ports allow the use of a USB barcode reader.

Protocols

Protocols are an agreed-upon format for transmitting data between two devices. The protocol determines the following:

- the type of error checking to be used
- data compression method, if any
- how the sending device will indicate that it has finished sending a message
- how the receiving device will indicate that it has received a message

The following Protocols available are:

Modbus

Modbus primarily sends data, no setup information is transferred via Ethernet or RS485 ports. The device ID and Serial number is held in the setup and this information is required to locate the correct device in **TrendServer**.

Modbus only requires the correct Slave ID to connect, see [“Modbus” on page 103](#). If the device is detected using the Slave ID the Recorder ID and Serial Number will be transferred, if the device is not detected an extra device will appear in the database containing the Realtime data.

Depending on the type of network being used, it maybe advisable not to use Modbus comms and FTP in the same time to the same PC. This may cause the FTP transfer to time-out.

Only data can be sent via Modbus. No recorder setups or events are sent for realtime and logged data.

However, a Modbus interface, such as Modscan 32, can be set up as Modbus master and used to transmit Totals, Digital Input, Digital Output, a Comms Variable (CV) or Messages to the recorder.

Modbus X

Modbus X protocol differs from standard Modbus by the reversed byte order of the floating point number. The Comms Server provides an integrated facility for testing a device to help decide which modbus protocol variant to use. See [“Edit a Device” on page 266](#). Modbus Mapping and Function Codes, see [“Appendix J: Function Codes and Memory Maps” on page 355](#)

Hardware Installation

Device and PC Ethernet connections

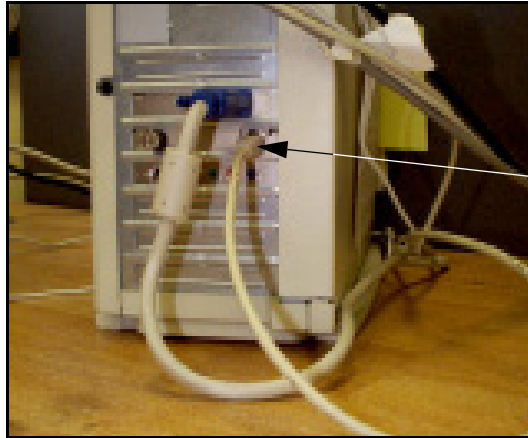

Connect an Ethernet cable from the Ethernet port on the back of the device to the Ethernet hub.

Connect another Ethernet cable from the Ethernet port on the PC to the Ethernet hub.

Hubs or Switches

Hubs and Switches come in all different shapes and sizes. Both are used as a common connection point for devices in a network. They are commonly used to connect segments of a LAN. A hub contains multiple ports and when a packet (Of data) arrives at one port, it is copied to the other ports so that all segments of the LAN can see all packets. Switches work in a similar way but send the data directly from one port to another. On a busy network this can be quicker and can have less data collision incidents.

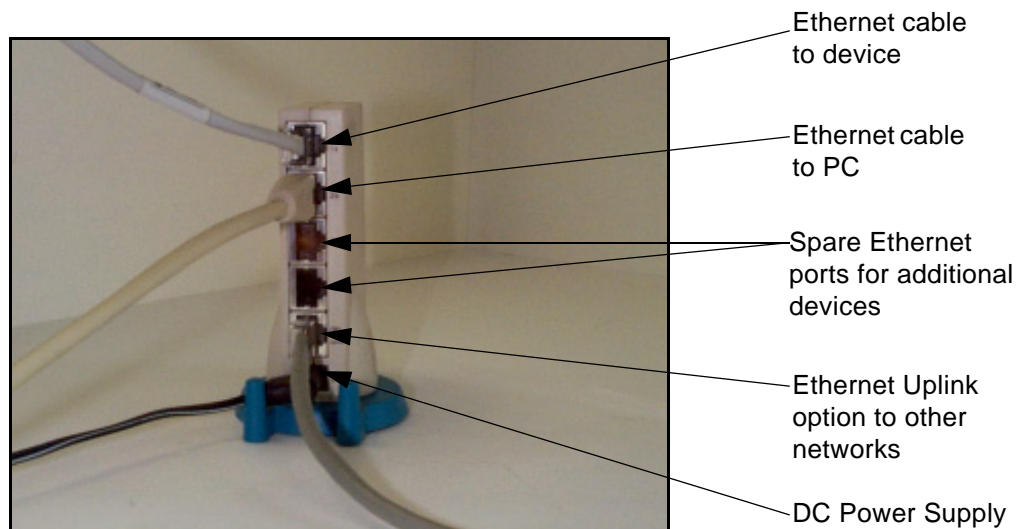

Getting connected - IP Address

Stand alone system

This is for connecting a local device direct to a PC using an Ethernet crossover cable. By using a crossover cable, the PC is able to receive data transmitted from the device.

Contact your IT systems administrator for setting up this link.

The TCP/IP properties are displayed showing the PC's IP address and the Subnet mask. Make a note of the IP Address and the Subnet mask. If there is no IP address or Subnet mask displayed, contact your IT systems administrator.

When this information is entered, the next stage is to configure the device.

[See "TCP/IP" on page 94.](#)

Figure 8.1 Stand Alone system

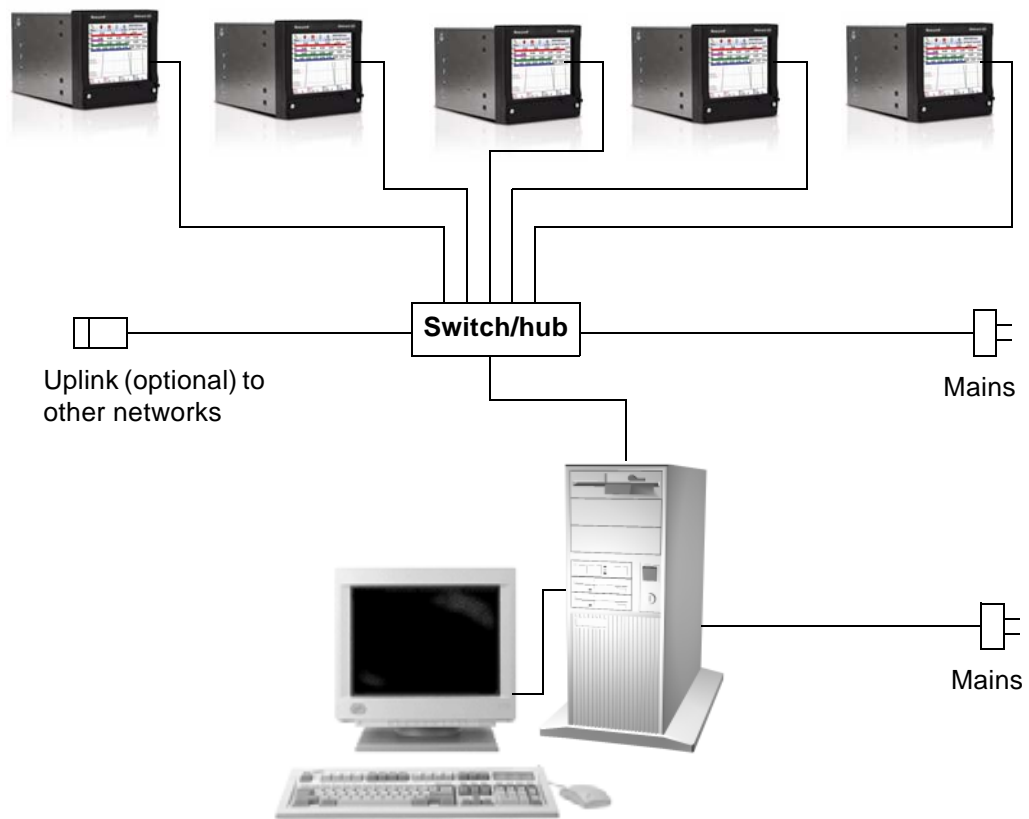

Local Area Network setup

This is a group of computers and/or associated devices e.g **Honeywell** devices, that share a common communications line and typically share the resources of a single processor or server within a local geographical area (e.g. within an office).

Figure 8.2 LAN Setup

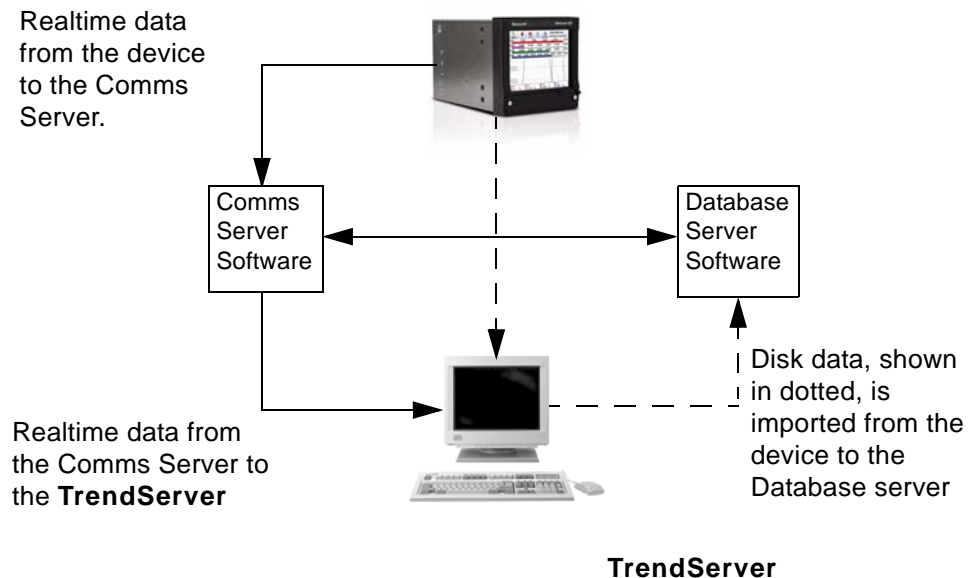

Links to Remote Networks

Communications is not just limited to local networks. Devices and databases on remote networks can be accessed using the **TrendServer** software via remote comms servers and remote database servers. Remote servers means it is not directly connected to your PC. [Figure 8.3, "Data Logging and Transfer," on page 251](#) shows an example of two local systems having access to each others remote servers.

TrendServer 1 can access Comms Server 2 and Database Server 2 and all the devices within the databases on those servers. Similarly **TrendServer 2** can access the devices and databases held on Database 1, and Comms Server 1.

Data Logging and Transfer

Using the **TrendServer** software, the device's details are added on to a database in **TrendServer** . Once the device has been configured and enabled, data can be retrieved. Data is logged to the internal memory. This data can be exported to **TrendServer** via:

- SD Card/USB (removable media) = transfer setup and data
- Network Share folder (NAS)
- Modbus (RS485/Ethernet) = transfer data only
- FTP (Ethernet) = transfer Setup and data

Hardware Installation

- Secure Comms = transfer Setup and data

Exporting does not remove the data from the device but when the internal memory buffer is full the latest data will start to over-write the oldest data.

Data can be imported from devices and logged to a **Database**, known as '**Stored** and **Historic** data'. Databases are managed by a **Database Server**. The data can be retrieved, graphed, exported to spread sheets, e-mailed or transferred from devices to other databases located on **Remote Database Servers**. Using the **Comms Server** actual current data can be sent from a device straight to the server using Ethernet or RS485 links. This actual current data can then be logged to a database and viewed on a graph in real time, this is known as '**Realtime**' data. Different types of data, realtime, logged and historic data can be displayed next to each other on a split graph screen. The comms server is used to configure logging and manage databases and reflect each devices status. [See "Communications Server" on page 258.](#)

SD card is available as a credit option for the **eZtrend GR** recorder.

Figure 8.3 Data Logging and Transfer

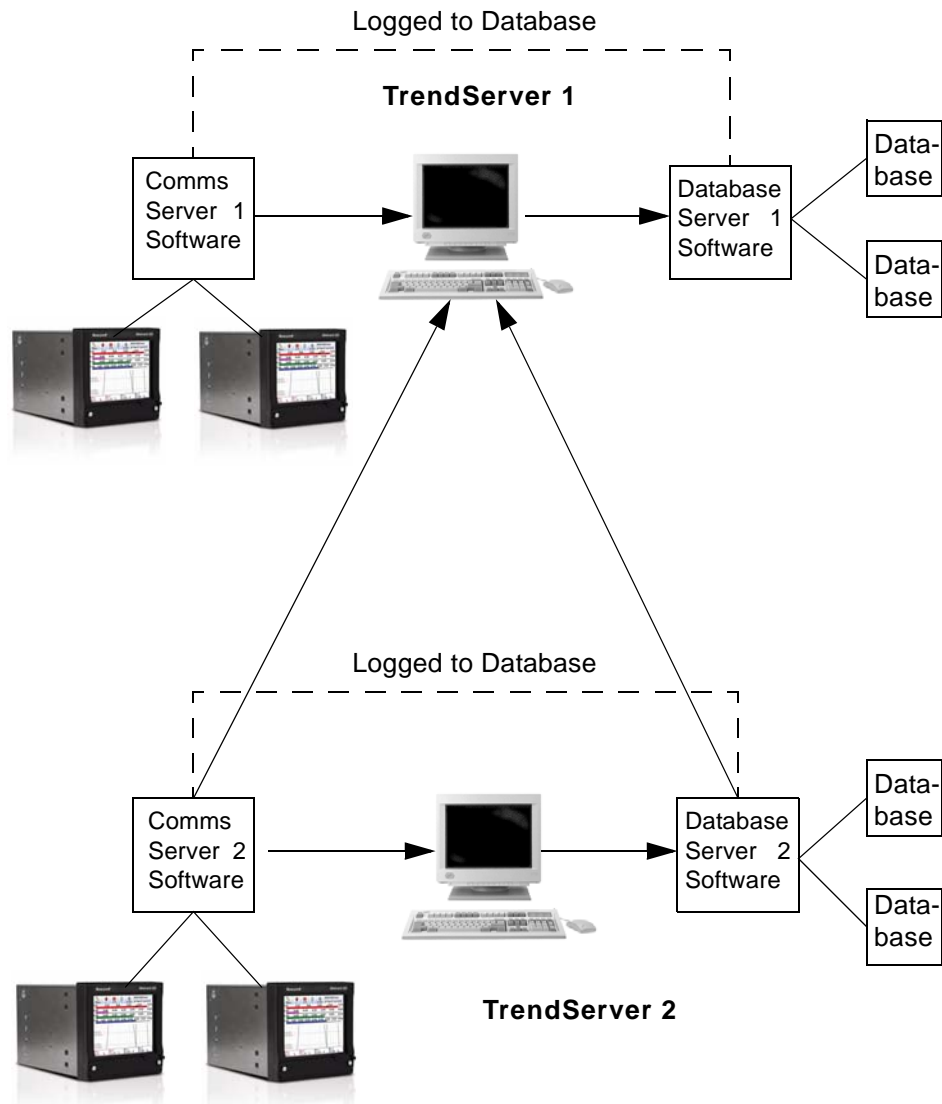

Comms and Trend Manager Suite

TrendServer software is required to set up and run communications to and from the devices and the PC software

TrendServer offers the ability to download and import data using **FTP** (File Transfer Protocol) via the **Ethernet Interface**. To use it you must have a device with communications fitted as standard or as an option on the **eZtrend** recorder with Ethernet as your active port and the FTP enabled.

TrendServer is part of the **TrendManager Suite** complete with its own **Communications Server** function. **TrendServer** is a fully network aware package which allows data viewing, archiving and communication over Ethernet and RS485. Ethernet can provide communications limited only by PC resources, and RS485 can provide comms for up to 31 de-

vices. Included as standard is the ability to e-mail, graph, print and export data. Device data can be entered into any PC on the LAN (Local Area Networks) and automatically viewed and graphed at any other PC on the LAN.

One of the unique features of the **TrendServer** software is the Realtime facility in conjunction with the Communications Server. Realtime data can be retrieved from the device to a PC via an Ethernet and/or RS485 connection. This data can be viewed, graphed and logged into the system. Data from the device can be logged to a database and held on a database server. Remote servers can be added to the comms server to allow access to remote devices on remote databases not on a local network.

Keep power saving options of the PC disabled, if enable it will turn off display and put computer to sleep which will stop real time data logging.

See “Database Size Management” on page 261.

System Requirements

Following minimum specification:-

- 1GHz Pentium IV processor or higher
- CD - ROM drive
- Monitor recommended screen resolution 1024x768 minimum requirement, high colour.
- Windows 7 (32 and 64 bit - Professional, Enterprise and Ultimate Edition), Windows 8, Windows Server 2008 and Windows 2012 server.
- 4GB Mbyte or more of RAM (min 4GB Mbyte recommended)
- 16 bit colour graphics, 24 bit recommended (Screen Designer only)
- 50 Mbyte hard disk free disk space (2 Gbyte for **TrendServer**)
- TCP IP installed (for **TrendServer**)
- SD card reader or USB port

TCP/IP = Transmission Control Protocol/Internet Protocol is the main transport protocol used on the Internet for connectivity and transmission of data across heterogeneous systems.

With all **Honeywell** software, performance improves with more RAM, faster CPUs, and faster and larger hard disk drives.

NB. It is recommended that at least 100 Mbyte of free hard disk space is available for archiving data. Please note the more logging and data being stored, the more free space on the hard disk is required. This is not required with **TrendViewer**.

Software Installation

The Comms server is only available with the **TrendServer** software. The comms server will auto install with the **TrendServer** software.

Ensure the same communications information is entered into the hardware and the software in order for the communications link to work.e.g. Device name and ID., IP address of the device etc.

Install **TrendServer** from the **TrendManager Pro Suite** folder and the comms server and database servers install automatically.

Before installing the software on to your PC, it is recommended to close down all other applications, including any programs that automatically load during the start up procedure.

It is not recommended to load multiple installations on the same PC.

Load the CD into the drive and wait for the autorun sequence to start. If autorun does not commence, follow these instructions:

- go to 'My Computer'
- select CD ROM drive
- select Launch.exe

Follow the instructions on the screen

During installation you will be asked to select or confirm the following:

- Which language variant (where applicable)
- Destination folder for the software:

A destination folder and file path will be designated, but this can be changed if required by using the browse button. Select which version of the application software to install.

This will be dependant on which version has been purchased. **TrendViewer**, **TrendManager Pro**, or **TrendServer Pro**. Select to install

Enter the code and organisation as supplied with each particular version of software. The code can be found inside the CD case. No code or organisation is required with **TrendViewer**.

NB: This is an alpha/numeric code and must be entered exactly in upper case. Codes from other **Honeywell** software will not work, each code is unique to the software supplied.

The **TrendManager Suite** may find it necessary to automatically upgrade certain applications within your PC to complete installation.

The setup will require a re-start (re-start your computer) to complete installation

Upgrades

There are three software packages available: **TrendViewer**, **TrendManager Pro Suite** and **TrendServer**. If your software upgrade is for the same package the software will automatically over-write the previous version. Local database information will not be affected and all devices data and setups are retained. Any other remote database servers will have to be added manually.

If you have purchased a different package to what is already installed, the new software will detect this and only make available the same package. To install a different package, first un-install the previous version. There is no need to save databases or data, these will not

be lost when un-installing the previous version. Devices and data held on a local database are retained for use with the new package as long as it is installed into the same directory.

Start Up

The **TrendManager Suite** has been installed on the hard drive of your computer in 'program files' unless during set up you have changed the destination folder.

To re-start the software, click on 'Start', go to Programs and select **TrendManager Suite**, then select either **TrendServer Pro**, **TrendManager Pro** or **TrendViewer** according to which version of software has been installed. A shortcut for your desktop is automatically created.



Start up **TrendServer Pro** by double clicking the desktop shortcut, or from the programs menu. It is advisable to ensure that each recorder has a unique Recorder ID number, this will make identifying individual recorders in **TrendServer Pro** much easier. This is set in the recorder Ident menu, see recorder user manual.

The first thing to do is to get the recorders setup into **TrendServer Pro**. This may be achieved by saving the setup at the recorder to SD card or USB key, then putting it into the PC and using the "Import" button. This method has to be used for a recorder on an RS-485 network and can be used for a recorder on Ethernet. Alternately the setup can be saved to the recorder by importing the setup that has been placed in a Network Share folder (NAS).

TrendManager Suite for the **GR Series** has options for adding **X Seires** recorders, including Import of Setups and Pen Data from Directory Location. If Import is from the Network, either FTP or Secure Comms (credit option) at that time it will not display the options. Also the mode of communication, i.e. Secure Comms or FTP will be decided at runtime based on availability of Credits for Secure Comms.

Secure Communications

Secure Comms is a Credit Option. [See "Credits" on page 131..](#) The Secure Comms protocol uses WSD and can be used to transfer data to and from a recorder recorder.

For information on Secure Comms, WSD and Secure FTP see ["Secure Communications" on page 100.](#)

Secure FTP

The **Trend Server** software, will have root authority certificate of server in trusted root certificates. Whenever **Trend Server** software connects to WSD service, SSL handshake will take place and on successful handshaking secure communication channel will be established and data flowing between these two end points will be encrypted. Only WSD clients with valid certificates can connect to WSD service. Data transfer between Recorder and **Trend Server** software will be in secure mode.

Figure 8.4 Import recorders

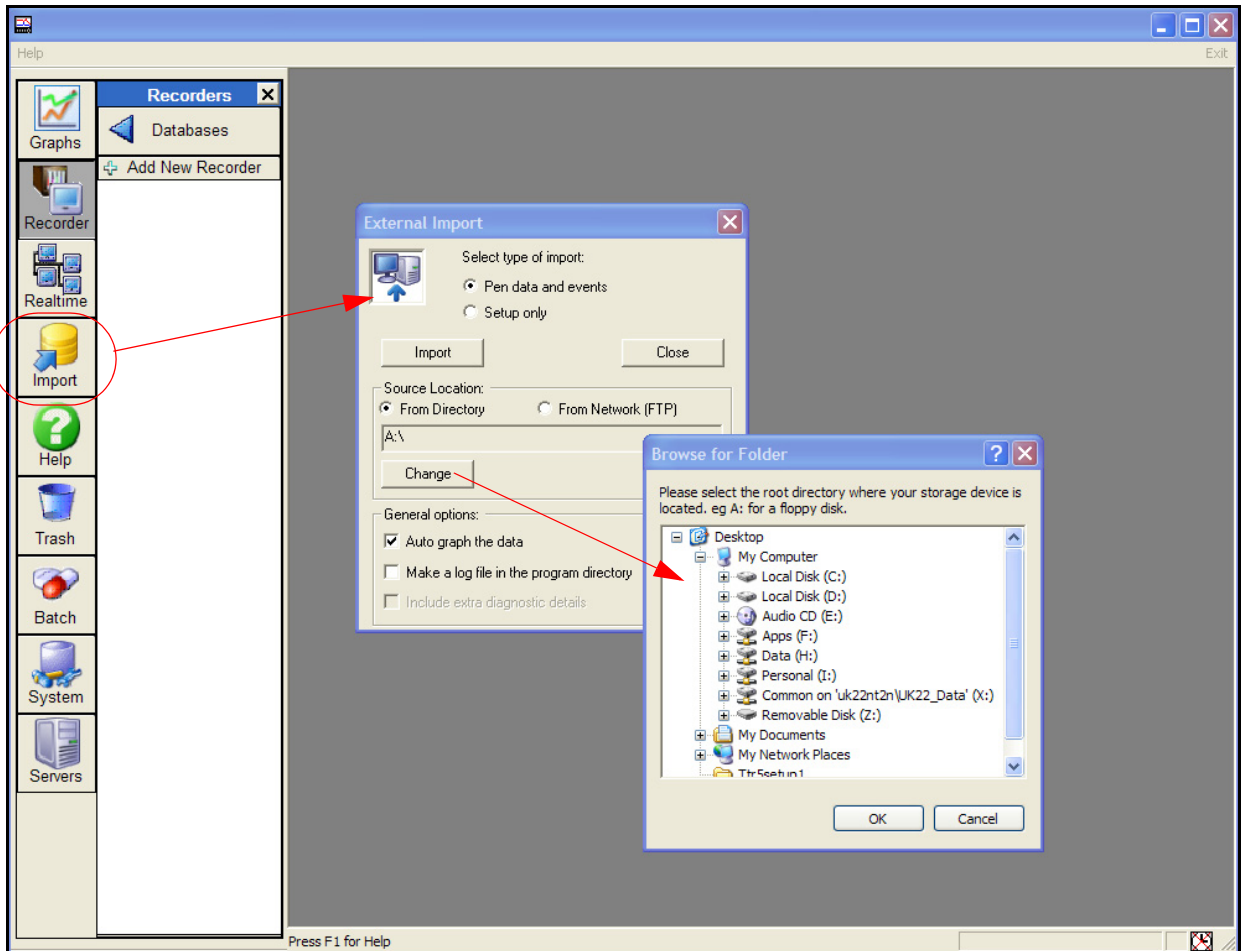

When the External Import box appears select "Setup only", use the "Change" button to browse for the device. Select the "import" button to import the setup to **TrendServer Pro**.

Comms and Trend Manager Suite

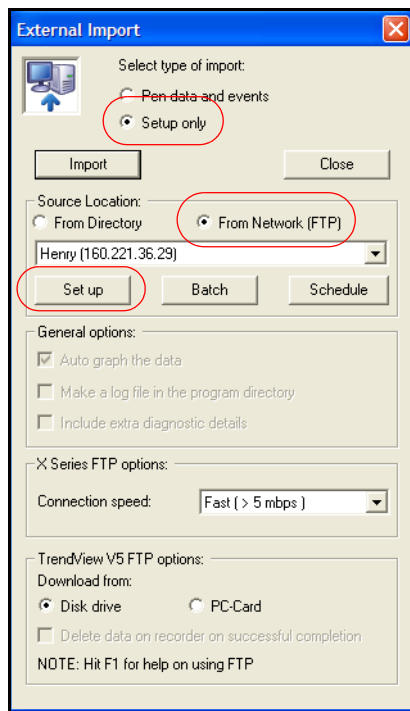

Or for Ethernet connections the setup can be down-loaded from the recorder via FTP. Select “Setup only” as shown, but change “From Directory” to “From Network (FTP)”.

When “From network” is selected the dialog box will change.

Hit the “Set up” button. The dialog box extends to allow you set up your recorder to allow FTP transfers.

Recorder information imported by FTP will not update in the Modbus Profile tool. To ensure the recorder details are updated in the Modbus Profile tool setup must be imported manually using removable media.

See for more details [“Modbus profile tool, data update” on page 265.](#)

Press the “Add” button to add a new recorder to the list.

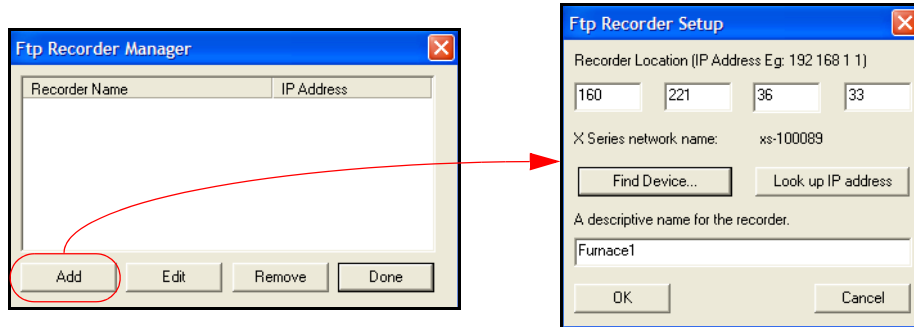

Enter the IP address from the recorder that you noted earlier. If you don't know it select the “**Look up IP Address**” button. The other method is to select the “**Find Device**” button. This will search for all **GR** recorders on the network using their Network ID, eg **xs-nnnnnn** (where “nnnnnn” is the recorder's serial number).

Give a name for the recorder. This should be something recognisable, all recorders should be given different names. Press OK.

On pressing “**OK**”, then “**Done**” you will return to the External Import dialog box as above.

Check that “**Setup only**” and “**from Network (FTP)**” are still selected. Then drop down the list and select the recorder you have just added. The recorder name and IP address are in the list.

Finally select “**Import**”, **TrendServer Pro** will download the setup from the recorder and this will be displayed in a setup window. Press **OK** and this recorder setup will be added to the recorder list.

Note: The recorder will be added to the list under the Recorder Name as set in the recorder itself. (This is the name that appears in the top right corner of the recorder

screen when in normal logging mode) NOT the name you gave the recorder when setting up the FTP.

If you select the “Recorder” button on **TrendServer Pro** this will show a list of all recorders currently logged with a setup. The recorder just added will be the last one on the list.

This name will be used to set up the Modbus Profile in Comms Server for the recorder.

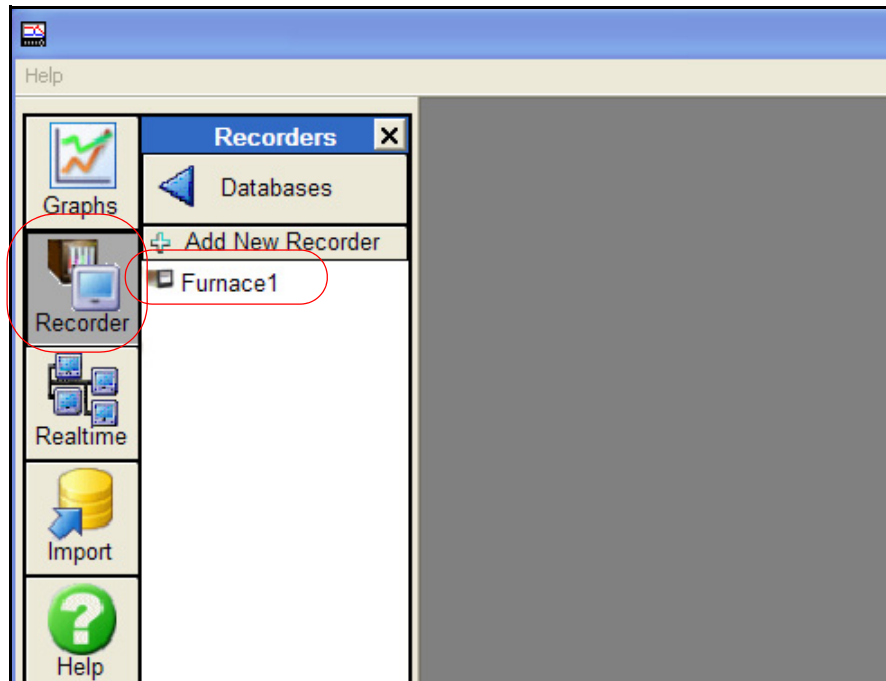

Importing Data via FTP

Select type of import as Data, this is the same as for Importing from a directory except that when importing data via FTP you will have a choice of New data or all data. The All function will import all the data in the recorder's memory to the external device port. The New function will just import any new data since the last import was made.

Communications Server

Comms Server Overview

The **Comms Server** and the **Database server** will run as a Service and can run independently of the **TrendServer** interface. Refer to the **TrendManager Pro Suite Software Manual**, Installation instructions. The Comms server will enable the user to:

- Monitor the status of communications with a device on any serial port, up to 8 ports and an Ethernet connection.
- Set up local and remote databases
- Set up local and remote servers
- Modbus protocols supported on Ethernet and Serial ports
- Enable and disable ports
- Add, edit and remove devices
- Log to database or client local connections.

Comms Server Start up



To start the CommServer

Go to Start -> All Programs -> Trendview Recorders -> **TrendServer Pro**

Launch Communications Server application, and this will bring the tray-icon.

The comms server manages the communications status of devices on a serial port (RS485) or through an Ethernet connection. Only Modbus protocol is available for **GR** devices, see [“Modbus” on page 246](#).

Comms Server Administration and Toolbar

Database Servers

Communications Ports

Figure 8.5
Comms Server Overview

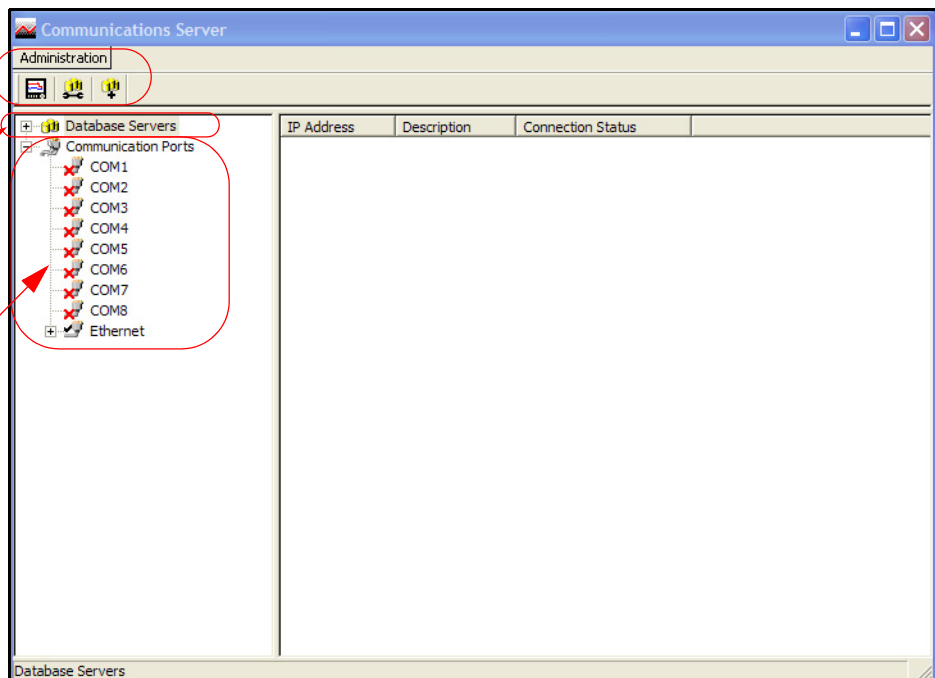

The Comms Status shows all the activity of devices, Communications ports, Databases and Database Servers. The window to the left displays the areas controlled by the comms server, the database servers and the communications ports. The display area(s) to the right will display details of any item selected in the left window. Depending on what has been selected the right window will split in two to give logging information. Items listed in the left window that have a + sign against them contain other items, click on the + sign to reveal the list of items contained within. The + sign will change to a - sign when all the items are displayed. To close the list, click on the - sign.

Comms Server Toolbar

Administration

The **Administration** button appears in the top left of the comms server, it contains:

- **Shutdown Server** - From here the comms server can be shut down this will disconnect the comms server, it will also shutdown the database servers at the same time.
- **Preferences** - The **General Settings** tab has an option to minimise the Server when it is opened. The **Diagnostics** option that will produce an additional tab to the bottom window, this will display properties and values of a selected device. **Send Recorder Events** is an option that needs to be enabled to allow event data to be exported when the export data function is performed and this will also allow event chart controls to be enabled. The **Clear Setup Cache** button will remove all setup files. **Network Settings** is for PC's with more than one network card fitted to access devices on other networks. The network cards are displayed here for selection. If the 'Use NIC Default IP Address Selection' is ticked then the first network card that was added to the list will always be selected.
- **Preferences** - The **Timing Setups** tab displays the current timings for the current communications setup. These entries should be configured correctly and not require any changes by the user.
- **Contents** - Enables the Help files.
- **About Communications Server** - Gives the version of the software.



Add a new Device to a communications port.

Use this icon button as one way of adding a device to Communications port. Other ways of adding a device are to right click on the desired port in the left window ie. Ethernet, and select the **Add Device** option. Or select a comms port in the left window, right click in a clear space in the top window and select Add Device. [See "Add a Device" on page 262.](#)



Configure Database Logging

Use this icon button to configure a device for logging channels to a database. Other ways to configure logging are to right click on a comms port or a device in the left window, or a device in the top window displaying the device for that port.



Connect to a new Database Server

Use this icon button to connect to a database server, either a **Local**, or **Remote Server** that has been added to the database servers list. Connection can be made by selecting 'Database Servers' in the left window and then right clicking in a clear space in the top window displaying the database servers list.

Comms ports

The **Communication Ports** is a list of ports available, **COM1** to **COM8** and **Ethernet**. As devices are added they are displayed under the port name. Click on Communication Ports to display a list of all the ports in the main window, tick the required port to enable. Click on a port and the main window splits into two windows, top and bottom.

The top window displays details of the devices using that port including device **ID No.**, device **Name**, **Mode** and **Status** show if the device is connected, how many **Channels** the device has enabled, an **Active** button to activate the device and the device's **IP Address**. As devices get added to each port they will display in the list for that particular port.

The default is N-8-1 which means no parity, 8 data bits and 1 stop bit. This is currently the only byte option supported by Comms Server.

Database Servers

The **Database Server** will list databases and display the devices within each database as they are added. Click on any of the database servers or the database within and details of that item are displayed in the main window. The main window will split to give additional information for databases showing comms port and device details.

Devices are added to the comms server through the Communications port, the device can then be configured for logging. The devices appear in the database and these databases are held within database servers. *Figure 8.5, "Comms Server Overview," on page 258*, shows the comms status screen, in the left window from the top is displayed Database Server, Local and remote database and devices held on the Local database. All Logging configuration for comms logging and logging to a database is set up from the Comms Server.

Connected databases are displayed with a green icon. If the database is in red it is not connected, check the **IP Address** and **Device ID** are correct and a protocol has been selected on the device. Un-tick and then tick the active box on the comms server to restart the database connection.

This section looks at the Comms Server's main elements displayed in the Status Screen: Database Servers, Local and Remote Servers, Databases, Communication Ports, Database logging and Client connections

Remote database servers can be added to the list to enable access to devices held in other databases on a remote database server in another location. To connect to a remote database server the IP address must be known of the PC where the databases server is held

Items with a '+' sign signifies there are items listed within. Click on the '+' sign to activate/expand.

- Listed under the Database Servers are a list of Servers.
- Listed under each Server are the Databases.
- Listed under each Database are the devices



This is the Database Server icon.



This is the Database icon

The bottom window has three actions, **Client connections**, **Database logging** and **Diagnostics**. When a device is selected from the top window details of the device's activity is displayed here. A device logging to a database will display details in the Database logging tab.

Realtime data will display in the Client connections tab. The Diagnostics tab can be activated by going to Administration, Preferences and ticking the Show Diagnostics box, this will display properties and values of a selected device.

Database Size Management

Although there is no fixed maximum size for a **Honeywell Trendview** recorder database, we recommend that they be limited to some practical limit, rather than just letting it increase in size unchecked. Large databases will impact the performance of your PC, the larger the database, the slower the performance of your PC will be; eventually the PC would stop as the hard drive is filled up. Another concern should be the protection of your database and archiving of the data in the event of a hard drive failure. Larger databases increase the time and effort required to back up the data and increase the risk of unintended data loss if there is a PC failure and the data is not backed up.

The PC's performance is dependant on the size of the database and the PC characteristics (e.g. Performance, Memory, Hard-drive space) along with how many recorders are connected to it. An initial recommendation would be that if your process involves archiving to removable media (DVD for example) then the Database should be kept to 4GB to ensure that it fits onto a DVD for long term storage. This would provide good PC performance, make archiving of the data easier and limit the risk of data loss between archives. As with any recommendation, you need to evaluate this relative to your needs; this is your data and it is important that a suitable process is put in place to ensure that it remains protected and secure while achieving adequate process performance.

Comms Server Setup

The comms server software can be run independently to the main application software by creating a shortcut to the Startup folder. If over-writing a previous version of **GR** comms server, only the local server will retain the database information and load all the devices and settings from the databases. Any other remote database servers will have to be added manually.

Comms Server - new user

Using the comms server from scratch requires:

1. Add a new device to a Communications port. Devices will appear under the Communications Port, when selected, in the left window and will appear in the initial database on the local comms server. [See "Add a Device" on page 262.](#)
2. Click on 'Communication Ports' in the left window to display a list of the ports in the main window. Tick the port that the device has been added to. [See "Comms ports" on page 260.](#)
3. For a realtime connection, check device connection status by clicking on the device under its comms port in the left window to display the device status in the top main window. Green LED's will show a realtime connection is made. If grey LED's are showing and the device displays 'Unconnected' and if Red LED's display then there is a problem with connection. Keep power saving options of the PC disabled, if enable it will turn off display and put computer to sleep which will stop real time data logging
4. The data from this device can now be logged to a database by using the Configure logging screen and setting up channels for logging with the log rate and type and setting up a destination database. [See "Logging Configuration" on page 268.](#)
5. When the realtime data is being run, eg. graphed to the application server software, this will enable the bottom window that will display details of the data.

Add a Database

To add a database to a server, right click on the server eg. Local Server, select Add Database and complete the dialog box details for the name and description of the device.

Add a Database Server

1. Use the database icon with a + sign in the top left of the comms server window.
2. Right click on Database Servers in the top left window

Connect to a Database Server

1. Select 'Database Servers' in the left window and then right click on the server to be connected in the servers list in the main window.
2. Connect to database server dialog box will appear, enter an IP address and a description to identify the database server.

Delete a Database Server

1. Right click on the database server to be removed and select the delete option.
2. A dialog box will appear with the IP address of the database server to be deleted. If this is correct, click on OK.

All database servers can be removed except for the Local Server.

Add a Device

There are three ways to add a device, they all deliver the same dialog box:

1. Use the device icon in the top left of the comms server window.
2. Right click on a selected Comms port in the left window, COM1 to COM8 or Ethernet and select Add Device from the resulting menu.
3. Select a Comms port and right click in a blank space in the top window and select Add Device from the resulting menu.

Add a Device via Ethernet.

Double click the ethernet icon in the left column. This will activate ethernet, the red cross will change to a tick.

Now the recorder must be added. To do this click the "add new device" button, The first in the row of three. This will bring up the Device Details box.

All these methods will produce the Add Device Details box. Areas of the box become greyed out as the selections are made.

Communications Server

Device Details - Add Device Details

Protocol: Modbus-X

Modbus Profile: xxxxxx - xxx

Communications Port: Ethernet

IP Address: 0 . 0 . 0 . 0

xxxxxx Network ID: xs-

Slave ID: xxx

Recorder Name:

Serial Number: Not available

Status: Active Inactive

Socket: 5001

Test Profile... Find Device... OK Cancel

- **Protocol** - The protocol should be matched to that set on the recorder. It will be Modbus-X by default so leave it at that unless you changed it on the recorder. For active Modbus devices, the recorder name and protocol variant can be changed (Modbus vs Modbus X). For an inactive Modbus device the device profile can also be changed.
- **Modbus Profile** - The Profile name box is used to tell **TrendServer Pro** how to access the data on the recorder. This profile is automatically generated from the recorder setup that was downloaded to **TrendServer Pro** previously. The system creates Modbus profiles from an imported setup or logged data and creates a profile including information for pen, scale, units etc. A set of profiles are available for **Honeywell** modbus devices. The profile Name is made up from the Recorder name, Type and ID number. Once the setup or data has been imported it will display in this window the next time that it is opened, no need to restart Comms Server. For **GR** recorders drop down the list and select the recorder from the list. It will be in the list under the same name as the setup previously saved. If any equipment, other than **GR** recorders is to use **TrendServer Pro** to log and graph data then a profile has to be generated. The Modbus Profile Tool is available to aid in setting up Device Profiles for other devices, see [“Modbus profile tool, data update” on page 265](#). For more detailed information on the Modbus Profile tool refer to the **TrendManager Pro Suite** software manual.
NOTE: The Recorder ID number is NOT the same as the Slave ID Number
- **Communications Port** - Choose between Ethernet or RS485 for COM ports 1 to 8. This may already be entered depending on how you have chosen to add the device. A Comms option card and expansion card are required for the **eZtrend GR** recorder.

Communications Server

- **IP Address** - Go to *Main Menu > Status > System > General*. In this list is the recorder IP Address. The comms server uses IP Addresses to locate devices on local and remote servers. **GR** recorders can also be located using their network ID.
- **Network ID** - **GR** recorders will automatically register a unique Network ID using the serial number. The format is “**xs-nnnnnn**”, where nnnnnn is the serial number of the recorder. This allows you to browse the recorder if you are using DHCP (Dynamic Host Configuration Protocol).
- **Slave ID** - This is a unique Modbus ID/Address used by the recorder to identify Modbus messages. Applications that talk to the recorder with Modbus will need to know this number to return messages to the device. Comms Server must the same number must match.
- **Recorder Name** - This is the name displayed in the top right any process screen on the recorder or found in *Main Menu > Configure > Setup > Edit Setup > General > Ident > Name*. The entered name will be used within comms server to reference the recorder.
- **Serial Number** - This is a read only box displaying the serial number for devices already on the network. This will display as Not Available when adding a new device.
- **Status** - This will automatically enable the designated port and the device will become active. This can be activated later from the main Comms Server screen.
- **Socket** - This number should not need to be changed, only by advanced users for networking.

When every thing has been entered use the “Test” button to make sure that everything is set up correctly. The **Test Profile** button enables the “Add Device” settings to be validated. It can be used to determine whether the recorder is configured for Modbus or Modbus X.

Because we are using Modbus-X, the Modbus-X column gives correct readings; the Modbus column returns wrong readings. (Vice-versa if using Modbus)

If the column shows the correct reading the recorder must be communicating correctly.

Communications Server

Press "Done".

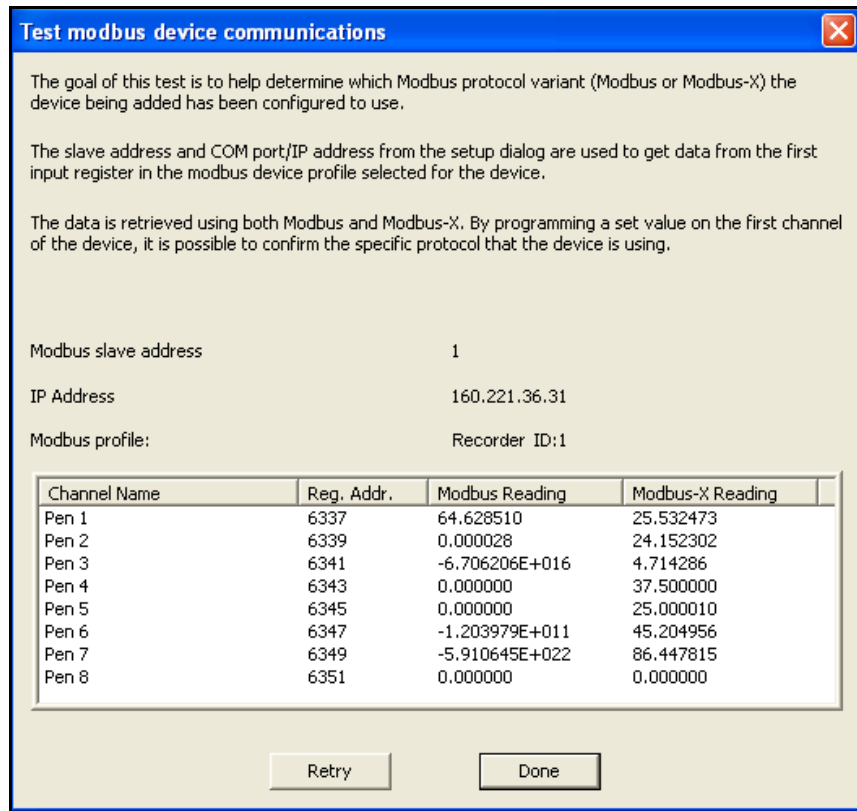

Find Device button

This can be used to find **GR** recorders on the network. It uses the recorder's unique Network ID to identify them and populate this list. Select your device from the list and press the Use Selection button to insert the recorder details into the Add Device box.

When you get back to the Add Device Detail Box, press "OK".

The recorder you have set up will now be added to the device list.

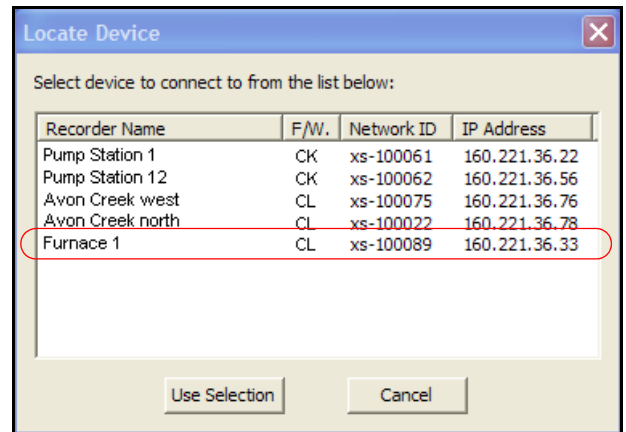

Modbus profile tool, data update

TrendServer Pro software will generate a modbus profile when data is imported from USB key, SD card, from a Network Share folder (NAS) or when it is manually imported via FTP. This applies to FTP of setup and FTP of pen data.

The automatic, or scheduled, FTP import of data from a recorder does not result in an updated modbus profile being generated. Once a modbus profile has been generated it is immediately available to the Comms Server but will not be automatically used by the Comms Server.

Any new connections created in the Comms Server will use the most recent modbus profile that has been generated when importing data on that PC.

For existing device connections, go to the relevant device and press right mouse button for the context menu. Select Edit Device and then press OK on the resulting dialog. The updated modbus profile will now be in use and this should be evident if you graph the data a couple of minutes later (give enough time for some data to be logged to the database using the updated modbus profile).

So in summary, when updating an **GR** recorder configuration, import the setup or pen data that use the new setup into **TrendServer Pro** software. Do this either via USB/SD Card/ Network Share folder (NAS) or a manual FTP operation, then go to Comms Server and bring up the "Edit Device" dialog (as described above) and press OK.

For more detailed information on the Modbus Profile tool refer to the **TrendManager Pro Suite** software manual.

Edit a Device

Select the Comms port containing the device for editing and right click on the device either in the left or top window. The Edit Device Details dialog box will appear showing the configuration for comms with that device. Any fields not greyed-out can be changed. For Ethernet devices the IP address can be changed. Any device can be made active or inactive from here. For active Modbus devices, the recorder name and protocol variant can be changed (modbus vs Modbus X). For an inactive Modbus device the device profile can also be changed.

For information on the **Test** button, see above. Click on the OK button to save the changes.

Delete a Device

Select the Comms port containing the device to be deleted and right click on the device either in the left or top window. Select Delete Device from the resulting menu. The Delete Device Details dialog box will appear showing the details of that particular device. Check this is the correct device for deletion, then click on the OK button and the device is removed, otherwise the operation can be cancelled.

Comms Server Logging

To set up logging you must first decide where to store the data. A database must be set up. The database can either be on the PC running Comms Server, or on another networked device.

There will be a database already set up by default on your PC when **TrendServer Pro** was loaded. This will be called "Initial database".

Communications Server

To set up a database on the PC click the “Database Servers” icon, this will expand to show “local Servers” i.e. databases on that PC. Click “local servers” to expand out to show all databases.

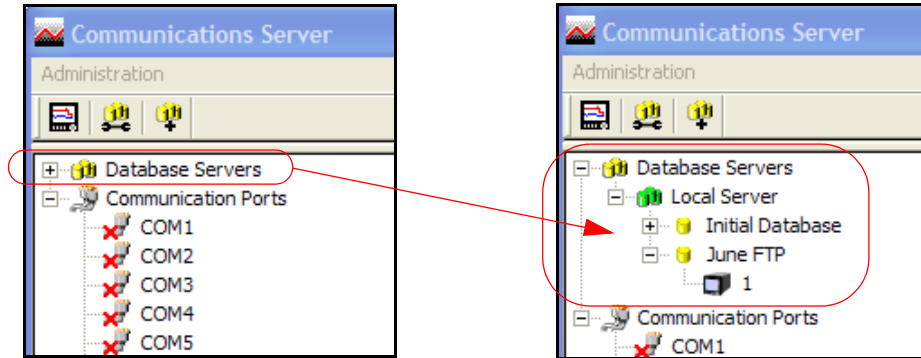

In the example shown there are two available databases. The default database called “Initial Database” and “June FTP”.

Databases can be added by right clicking on the “Local Server” icon and then clicking “Add Database”. Enter a database name and description, click OK and the new database will appear on the list.

To add a database server you will need the IP address of the device that will be the database server. Click the “new database server” button.



New Database Server

Logging Configuration

Enter the IP address and a new database server will be added. Add databases to this server as above.

Logging Configuration

This screen configures channels for logging from a device to a database. It can be accessed in several ways.

Figure 8.7 Logging Configuration

| Source | Rate | Type | (new settings) |
|------------|-------|--------|----------------|
| Pen 1 Temp | 1 sec | Sample | edit |
| Pen 2 | 1 sec | Sample | edit |
| Pen 3 | 1 sec | Sample | edit |
| Pen 4 | 1 sec | Sample | edit |
| Pen 5 | 1 sec | Sample | edit |

This example of the logging configuration box was produced by right clicking on a specific recorder. Some of the areas have been auto populated.

1. Use the Configure Database Logging icon at the top left of the screen and select Configure Logging from the resulting menu.
2. Right click on 'Communication Ports' in the left window and select Configure Logging from the resulting menu.
3. Right click on the comms port and select Configure Logging from the resulting menu.
4. Right click on the device and select Configure Logging from the resulting menu.

Any of these will display the Logging Configuration box. If this screen is selected from either a comms port or a device then the comms port information will already be inserted. If the screen is selected from the icon or Communications Port heading then the comms port will need to be assigned. Select the device ID number (if necessary), from the drop down menu.

The next section is Database Configuration, a list of connected database servers and a list of databases that are currently being logged to. In this section is a window showing the channels available to be logged. As channels are selected from this window, three additional buttons become active: 'Add Channel selection', select each channel for logging, 'Add all Channels' for logging and Clear Channel selection.

Add Channels for Logging

As each channel is selected, or all channels depending on the button selected, the Logging Channel Configuration box appears so the Log Rate and Type of logging can be set for each channel individually or all channels.

If “all channels” are added the next box will ask how often you want these channels to be logged (log rate), this can be a sample every second to one sample every 24 hours. This selection will apply to all channels.

If channels are added one at a time using the “Add Channel Selection” button the same log rate box comes up, but a different log rate can be set for each channel.

When all the required channels have been added click OK.

When the channels have been selected they will appear in the bottom window, click on Apply to enable the channels to log. Once the channels are in the ‘Channels logging to selected database’ window they can be selected and the Edit and Delete button become active. The Edit button allows the logging rate or type of logging to be changed.

There is also a Database Events Logging box that can be ticked that allows any events to be logged to the database using Trendbus. (Not available for **GR** recorders).

Summary of Logging Changes - If any changes are made using the Edit button, the Summary of Changes button becomes active, this will show the last changes made to any of the channels for this configuration only.

The Delete button will take the channel out of this window and put it into the window showing available channels for logging, logging will stop for this channel.

The set up is complete and the logging to the database should start immediately.

To check the setup, go back to the Comms Server screen.

Communications Server

Comms Server Status Screen

If you have a graph open Comms Server should be showing that the recorder is operating by displaying flashing green lights in the "Active column". Click and highlight the recorder. Click the "Database logging" Tab. The screen should now show all the pens logging for that recorder and their log rate

Figure 8.1 Comms Server Status Screen

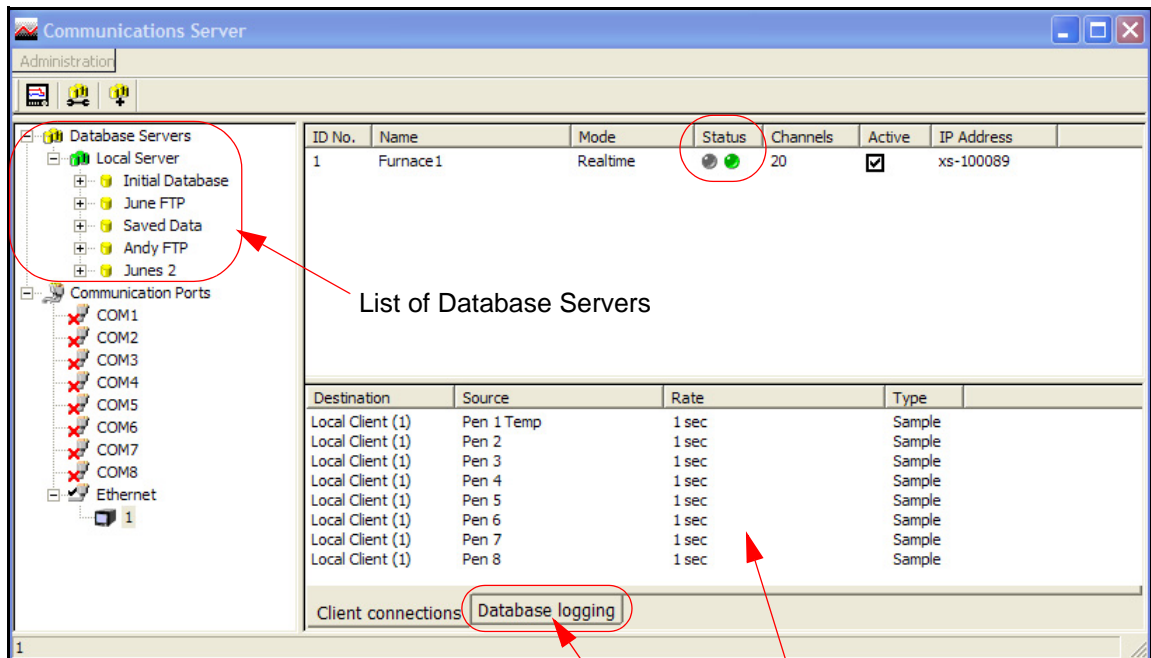

List of Database Servers

Client Connections tab displays any Pens being graphed

Database Logging tab displays any Pens being logged

| Destination | Source | Rate | Type |
|--------------|------------|-------|--------|
| Local Server | Pen 1 Temp | 1 sec | Sample |
| Local Server | Pen 2 | 1 sec | Sample |
| Local Server | Pen 3 | 1 sec | Sample |
| Local Server | Pen 4 | 1 sec | Sample |
| Local Server | Pen 5 | 1 sec | Sample |
| Local Server | Pen 6 | 1 sec | Sample |
| Local Server | Pen 7 | 1 sec | Sample |
| Local Server | Pen 8 | 1 sec | Sample |

Comms Server can be minimised now, it will continue to run in the background.

Client Connections

Realtime comms data from the device will only display on the comms server communications status screen when realtime data is active on either the server software. Once data is active on a client connection, this window will display details of the device selected in the top window: its Destination or where the information is going to, Source or origin of the data (channel or event), Rate and Type of data sampling being communicated. Database Logging

Communications Server

This tab will display information on what is currently being logged to a database for the device that is selected in the top window: its Destination or where the information is going to, Source or origin of the data (channel or event), Rate and Type of data sampling being communicated.

A third tab, **Diagnostics**, can be enabled using the Administration button, and selecting Preferences.

Send Recorder Events

Comms Server has a set of chart controls that can control the chart on the recorder from your PC. This can be done in [“Realtime chart controls” on page 271](#) or can be setup as an Effect of an Event.

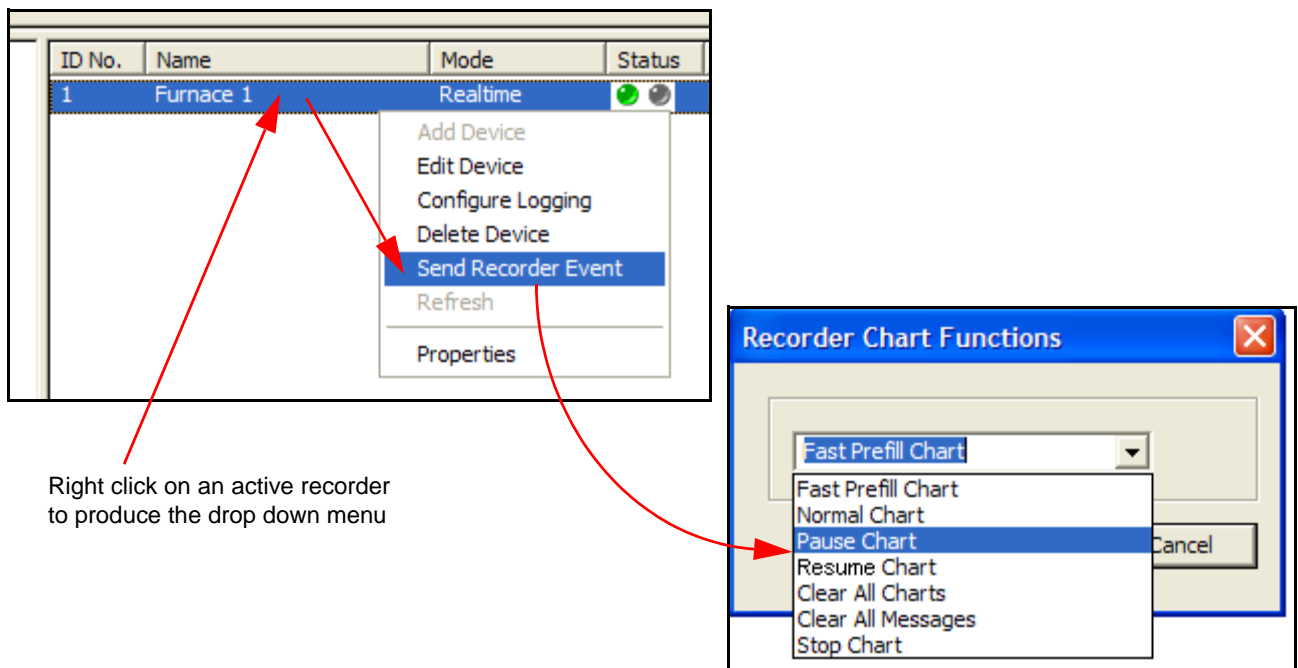

Realtime chart controls

Right click on an active recorder in Comms Server, Ethernet or RS485 from the recorders listed in the left hand window or from recorders in the main window.

- From the list select Send Recorder Events and the Recorder Chart Functions box will appear. If the option is not in the list go to Preferences in [“Administration” on page 259](#).
- Select a chart control function for immediate effect on the recorder. Because **TrendServer Pro** is graphing the data that is being transferred in realtime the recorders running on **TrendServer Pro** will not be affected.

Event chart controls

The same set of chart controls can be activated using the event system in **TrendServer Pro**. Chart controls can be used as an effect of an event happening. In the Events tab in **TrendServer Pro** set up a cause to trigger the effect of a chart control.

Communications Server

- **Pause** - this will pause the chart until it is resumed. Resuming a paused chart will display continuous chart data from when it had been paused. The chart can be stopped if in a paused state.
- **Stop** - this will stop the chart and no chart data will be displayed for the length of time the chart is stopped. If a stopped chart is resumed there will be a gap in the displayed chart data.
- **Resume** - this can be used after the chart has been stopped or paused. The chart data will continue from where it has been paused with no gaps displayed. But if the chart has been stopped the displayed data will display a gap in data until it is resumed
- **Clear** - this will clear all the data being displayed. Data will not be cleared if the chart has been stopped
- **Prefill** - this will clear the chart and then fill it with the current reading.

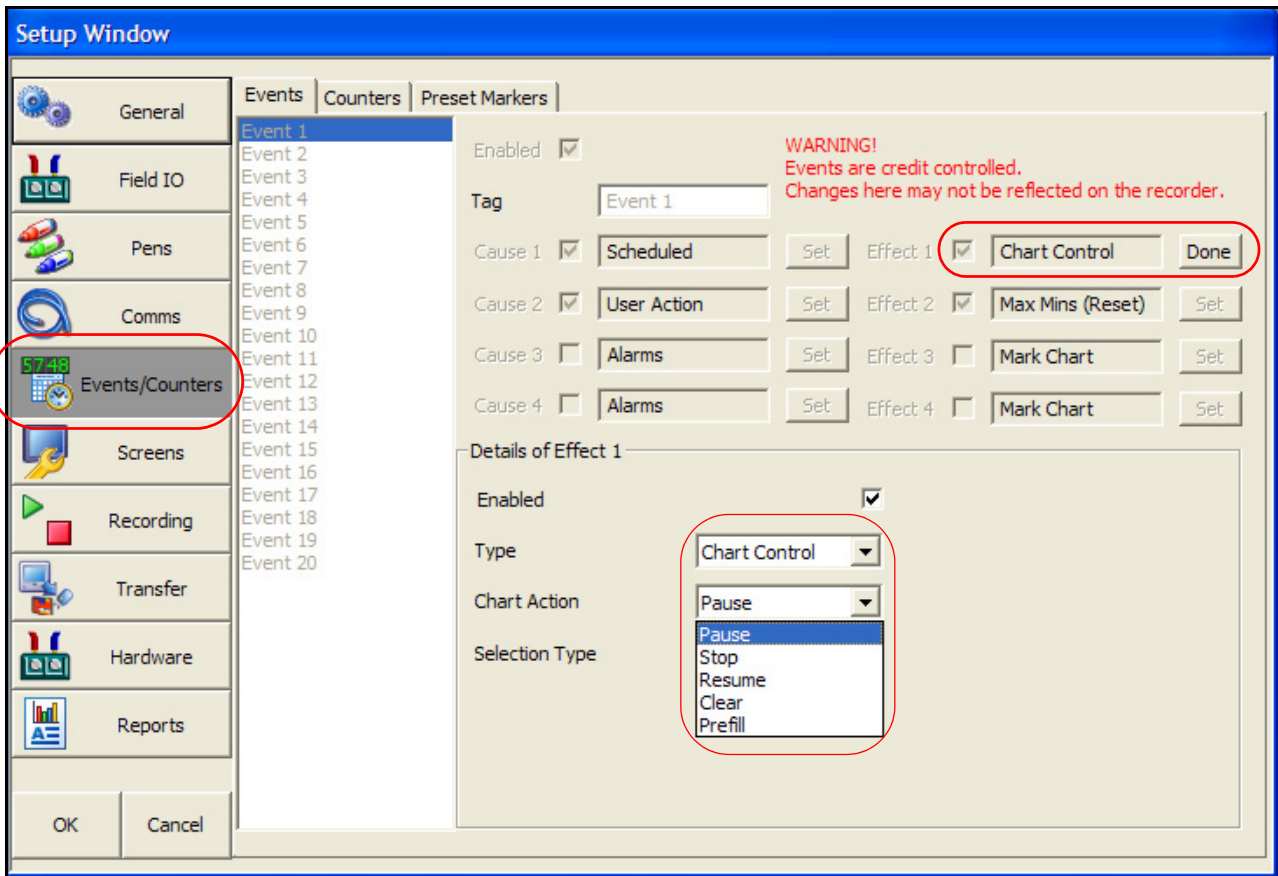

Realtime Graphing

To graph real-time data on **TrendServer Pro**, press the “Real-time” button located on the left hand side. This will list all the recorders currently connected. The recorder set up on Modbus will be in the list. The recorder will be in the list under the name that you gave it when entering the device details.

Either click and drag the recorder name from the list to the graph area, this will add all the recorders pens onto the graph, or click on “pens”, to list the pens available and drag the required ones onto the graph.

As soon as the pens are on the graph they should start to update in real-time. The graph will be split into two as below.

Figure 8.9 Realtime Graphing

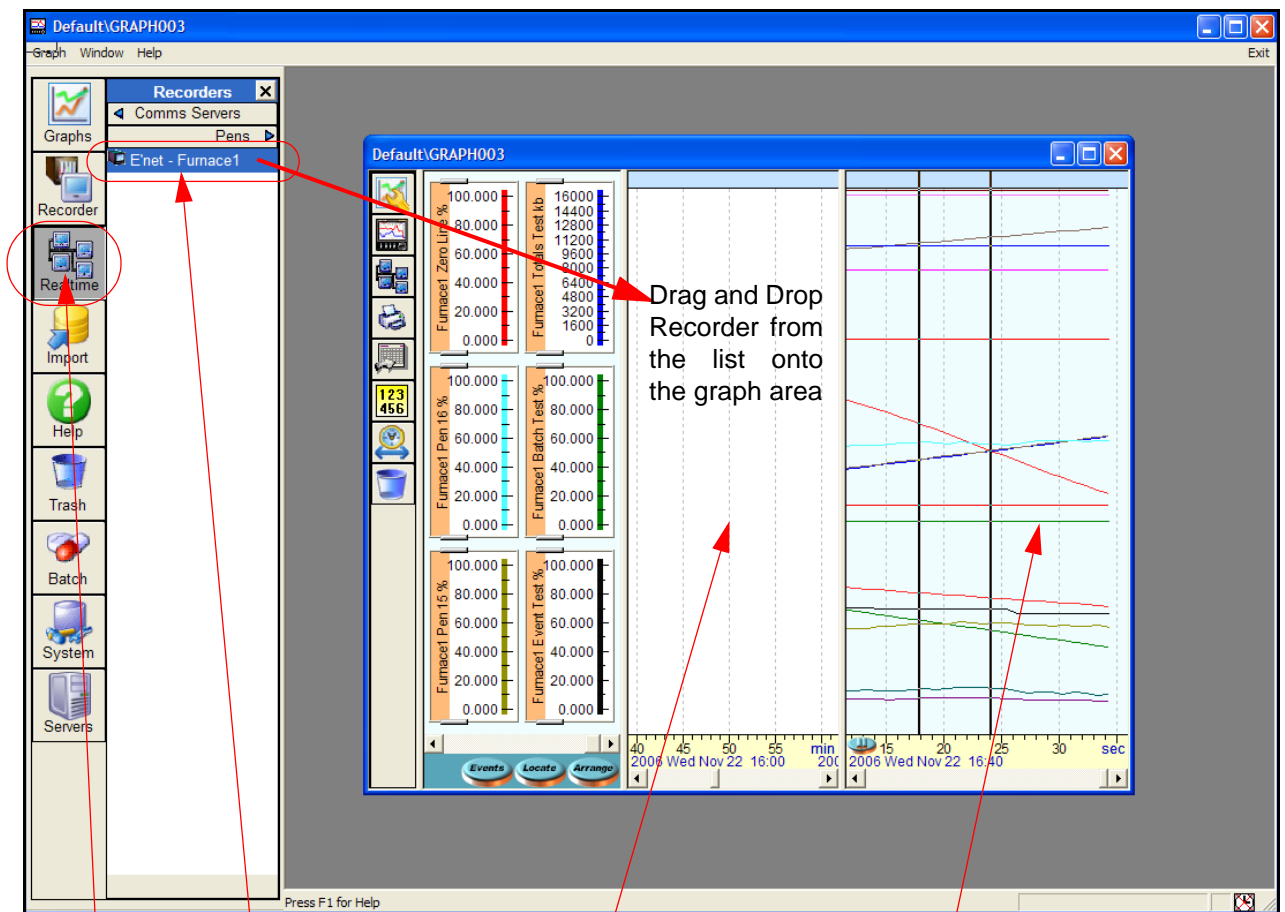

Realtime button

Modbus recorder

The white background area is the historical data.

The blue background area is the real time data.

The white area for historical data will display the data that is stored to the database. At this point we have no data being stored to the database, it is simply being acquired and graphed, if the graph is closed any data downloaded via Modbus will be lost.

More information about graphing on **TrendServer Pro** and the options for arranging pens etc. are available in the **TrendManager Pro** software manual for this product. If this documentation is unavailable it can be downloaded at www.honeywellprocess.com.

Comms Server Database

On system start up the Communications Service will start automatically . This service is responsible for launching database related components. See [“Comms Server Start up” on page 258.](#)

System Setup

The system can be set up two ways.

1. For customers who are setting up in preparation for the arrival of their devices. Using the **TrendServer** and Comms Server software, create a database for the device(s) and configure each device for logging using the comms server. When the devices are in place and connected check the IP address (for Ethernet devices only) and the device ID is correct.
2. For larger networks - Set up the hardware first noting each devices ID and IP address. Use the comms server software to set up the devices on a database and configure logging for each device. The devices will need to be set up on the **TrendServer** software before the connections can be tested and become active.

Shutdown Server

The Communications Server appears as an icon in the Windows system bar at the bottom right of the screen. Right click on that icon and you will see the pop up below.

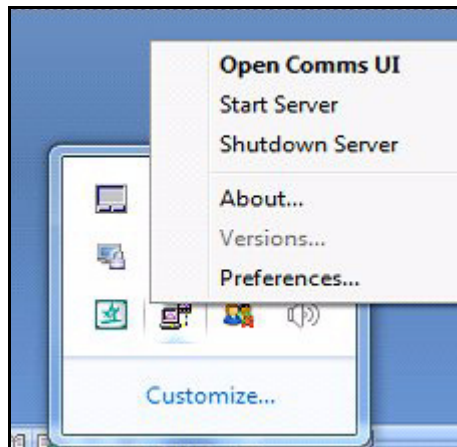

Select Shutdown Server and the following message box would pop up

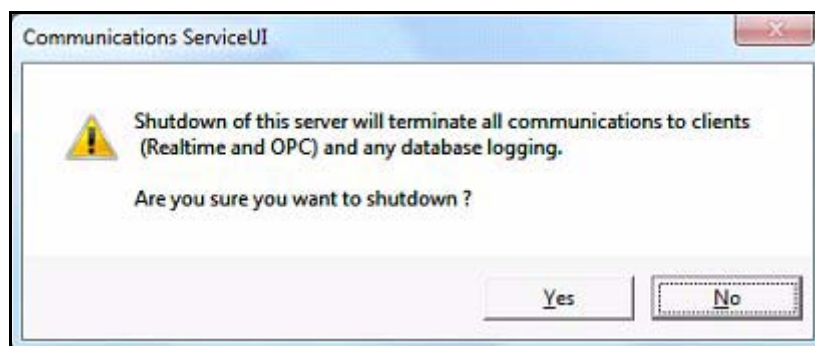

Select "Yes" and the following events will happen

Shutdown Server

If the Communication Service UI is open with Non-Admin privileges, the following message will appear. Select “OK” and the Communication Service UI will be closed but the **TrendServer** software will still be running:



If the Communication Service UI is open with Administrative privileges, the following message will appear. Select “OK” and the Communication Service UI will be closed and **TrendServer** software is also successfully stopped.

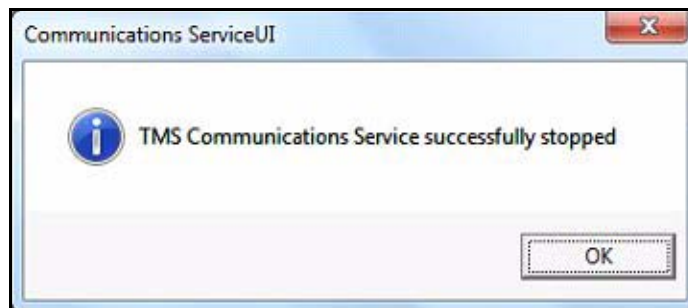

Select “No” and no actions will be taken

Modbus Capabilities:

1. The Comms Server is a Modbus master. It has no slave capability.
2. The maximum speed of data transfer over Modbus is 1 (one) reading per second / per channel
3. The maximum speed of data logging of realtime Modbus data is 1 (one) reading per second/ per channel.
4. The maximum number of devices depends on whether the connection is serial or ethernet.
 - On the serial port, there is a physical limit of 31 devices. The Modbus comms can support anywhere between 4 and 10 devices at a rate of 1 reading per second depending on the complexity of the recorder configurations. As the rate is decreased from 1 (one) reading per second, the number of supported devices increases.
 - On the Ethernet connection, the current physical limit is 247 recorders talking Modbus due to a requirement that the Comms Server must have a unique ID for each device in the network. Additional **Honeywell V5** recorders using the Trendbus protocol could be supported on the network as long as their device IDs remain unique. With Modbus connection, anywhere between 24 and 64 devices are supported at a rate of 1 reading per second, again depending on the complexity of the device configurations. As the rate is decreased, the number of devices supported increases.

5. The maximum number of pens supported at once per second for a given device is 32. Up to 64 pens supported at once every 5 seconds. Then all 96 pens at once every 10 seconds for the **Multitrend GR** recorder.

The above specifications should be used as a guideline, because factors such as network speed and reliability could impact performance.

Web Browser

The Web Browse function can be enabled/disabled from the recorder. This allows you to view the recorder information only. The web button can be password protected if passwords are enabled. See [“Web” on page 106](#). This is a firmware option that first needs to be activated in Options, see [“Credits” on page 131](#). The Remote Viewer is a firmware option that can be added to allow access to the recorder from a web page. The Remote viewer option needs to be activated in the Firmware options screen, see [“Credits” on page 131](#).

To access your recorder’s web page, type the device’s IP address in to a web browser such as Internet Explorer. If Microsoft™ WINS system (Windows Internet Name Service) is available then the device name can be used to search for the device web page. To find your recorder IP address see [“TCP/IP” on page 94](#).

The recorder will automatically register a unique Network ID using the serial number. The format is **xs-nnnnnn**, where nnnnnn is the serial number of the recorder. This allows you to browse the recorder if you are using DHCP (Dynamic Host Configuration Protocol).

On recorders with password security enabled further login will be required to access Full Remote Control of the recorder from the web page and to enable a keyboard and mouse. For users with Password functionality enabled Login is required. Enter your User name and Password* in the box to gain access to the recorder web page.

Note: When using remote viewing with password control, a user’s password can be viewed at the recorder. Care is required to prevent exposing a user’s password during the remote entry of the password.

For Users without Password security just choose a language option to access the web page.

Select **Remote Viewer** to enable a desktop user interface. This will allow you to view and control your recorder in realtime.

***NOTE:** When using the remote control function for the recorder if you need to enter password in the recorder, it is recommended that you use the external keyboard and not the Recorder SIP (Soft Input Panel).

IP Address Troubleshooting

If your recorder’s IP address begins 169.***.***.*** this means there is no DHCP Server (Dynamic Host Configuration Protocol) available to create a dynamic IP address. Either, make a DHCP server available or allocate a Static IP address, see [“TCP/IP” on page 94](#).

The recorders IP address can be viewed in the Status menu, see [“General” on page 195](#).

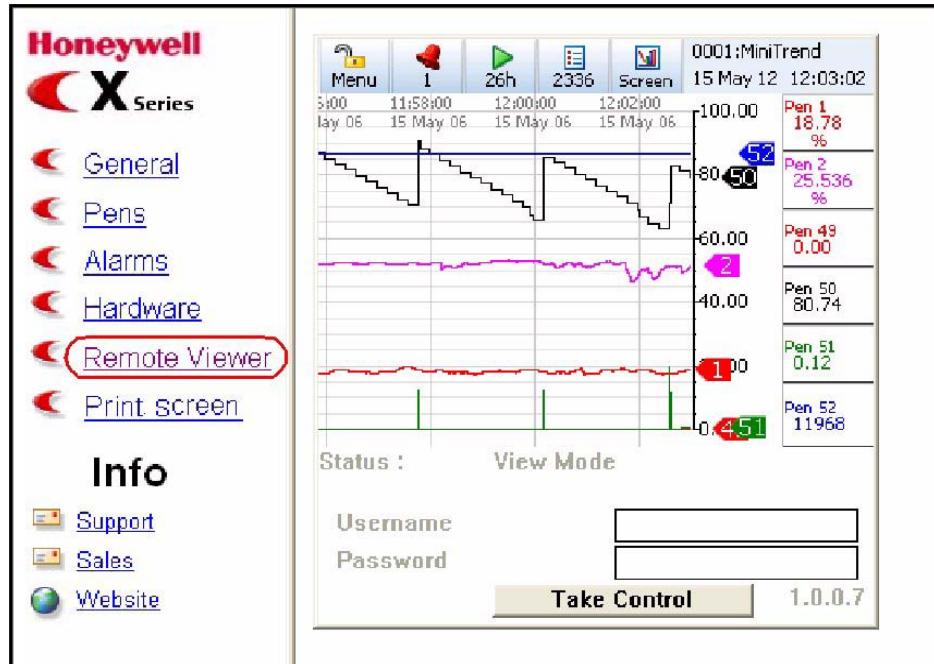

Internet Security Settings

Types of web browser for use with the Remote Viewer include Internet Explorer 5 and above.

[Figure 8.10, "Internet Security - Windows 7," on page 278](#) shows an example from Internet Explorer 10 on a Windows 7. The settings shown are for Internet access. If the device is to be accessed in an intranet scenario then the same has to be done for local intranet option.

Firewall settings

If this device is sitting on an enterprise network with a firewall in place then the firewall should be configured to allow all requests on port 80 and port 976 (this is for remote control Active X). There is also one port for FTP control, which should be opened. Access to the firewall settings will differ depending on what firewall is installed.

Active X Control

Depending on your set up and if passwords are active, a dialog box will appear for Internet Explorer Digitally Signed Active X Control; if prompted select Yes.

To browse multiple recorders, IE8 or higher version is required

Internet Security Settings

Access to the firewall settings will differ depending on what firewall is installed.

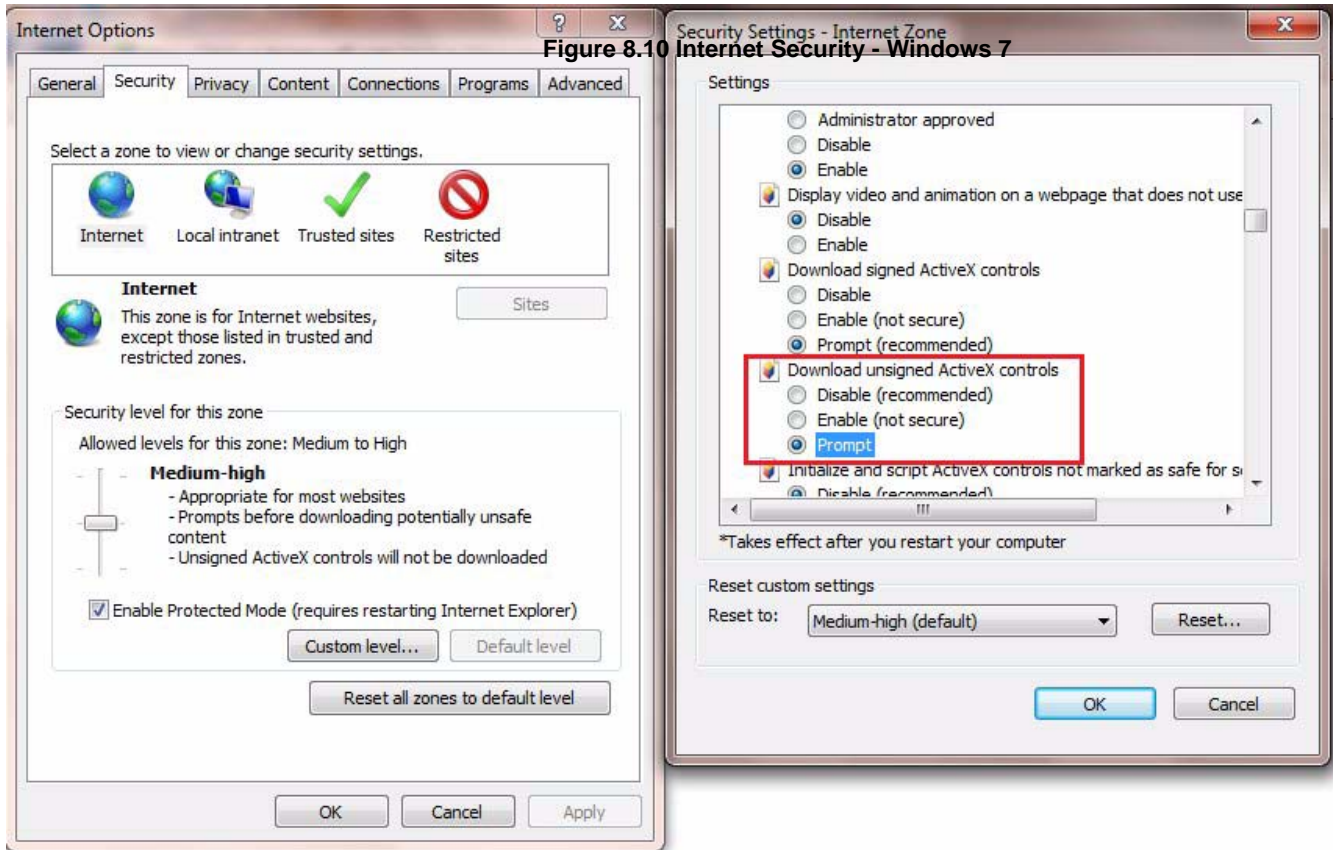

NOTICE

Please ensure any firewall settings on the desktop are permissive of the (Comms Server/ Trend Server) and that ports set up in the configuration (default 8955 TCP and 8956 UDP) are allowed passage through the firewall.

Section 9: PC Software Suite

The TrendManager Pro Software Suite

The **TrendManager Pro Software Suite** complements the capabilities of the **GR Series** recorders by providing the benefits of viewing, configuration, network communications, database management, data analysis and report generation using a personal computer. It ties the process together, providing for real-time or FTP communications with the recorders through a Local Area Network (LAN).

TrendViewer

This is the standard software provided with the recorder that displays and prints data imported from the storage media used by the recorder.

TrendManager Pro

This is an advanced data analysis/archiving software package, providing full configuration of the recorders. **TrendManager Pro** is a stand-alone package that delivers to the user total recorder configuration, allowing the user to archive, graph, print and export data. It also allows files to be exported using comma separated variables (CSV) format, that can be imported into most computer software.

TrendServer Pro

This is a fully network aware software package for real-time viewing and archiving of data with communications to the recorder. It supports all the capabilities of **TrendManager Pro** plus real-time data acquisition, FTP (File Transfer Protocol) and web browser access. **TrendServer Pro** provides secure multi-level, multi-user access to the recorder data by various departments with security. Standard features of **TrendServer Pro** include data archive tools, Email set up and alarming, graphing, print import and export data facilities.

Trend Manager Pro with OPC Server - provides the same functions as the TrendServer Pro but includes the added function of an integrated OPC Server to allow easy interfacing to third party HMI software packages that support an OPC Client. This provides a real-time interface between servers and clients.

Modbus Profile Configuration Tool - this is a tool that comes as part of the **Trend Server** software that allows the user to set up Modbus Device Profiles for use by the Communications Server. It allows the user to set up other Modbus devices other than the **Minitrend GR** and **Multitrend GR** and **DR Graphic** recorders to get real time data into **Trend Server** .

Communications Server

The Communication Server is supplied with **TrendServer Pro**. It manages real-time communications, distributed access to the stored data, time synchronisation over Ethernet networks. The Communication Server provides security for the transmission and storage of process data.

X Series & GR Recorder Screen Designer

Not available for the **eZtrend GR** recorder.

Screen Designer - is a separate software package that enables the user to design unique display layouts for transfer to the recorder's screen. Screen layouts can be created using a combination of indicators such as Trending Charts, Digital Panel Meters and Bargraphs. Flexibility allows each type of indicator to have elements of its appearance changed to create an individual presentation.

The Screen Designer software package is compatible with all **Minitrend GR** and **Multitrend GR** and **DR Graphic** recorders. Layouts can be transferred on to single or multiple recorders of the same type, which contributes to continuity and standardization of process data.

Database Management Tool

Database Management Tool - this software application works with **TrendManager Pro** and **TrendServer Pro** to provide safe administration of data with tools to archive, sort, move, copy and delete the data stored in local and remote databases. The Database Management Tool software is supplied with **TrendServer Pro**.

Report Generation Tool - AMS2750

PC software that uses a TUS data file generated by the **Multitrend GR** and **DR Graphic** recorder to generate a temperature uniformity survey report. It produces a report that documents the uniformity performance of a furnace based on the AMS2750 specification. AMS2750D is the specification that covers pyrometric requirements for thermal processing equipment used for heat treatment.

System Requirements

| Minimum System requirements for TrendViewer:- | Minimum System requirements for TrendServer Pro TrendManager Pro and Screen Designer: |
|--|--|
| 1 GHz Pentium processor or higher with a mouse, CD-ROM drive | 1 GHz Pentium processor or higher with a mouse, CD-ROM drive |
| Monitor screen resolution 1024 x 768 recommended minimum, high colour | Monitor screen resolution 1024 x 768 recommended minimum, high colour |
| Microsoft Windows™ 7 (32 bit – Professional and Ultimate Edition - 64 bit), Windows 8, Windows 2008 Server and 2012 Server | Microsoft Windows™ 7 (32 bit – Professional and Ultimate Edition - 64 bit), Windows 8, Windows 2008 Server and 2012 Server |
| 4GB or more of RAM (min 4GB recommended) | 4GB or more of SRAM (min 4GB recommended for generating IQOQ reports) |
| 16 bit colour graphics, 24 bit recommended (Screen Designer only) | 16 bit colour graphics, 24 bit recommended (Screen Designer only) |
| 50 Mbyte free hard disk space | 2 Gbyte Hard-drive free disk space |
| Flash card reader or USB port for X Series recorders | Flash card reader or USB port for X Series recorders |
| 3.5" floppy disk drive or PCMCIA for V5 recorders | 3.5" floppy disk drive or PCMCIA for V5 recorders |
| | TCP IP installed |
| | Graphics Card & Direct-X control installed (Screen Designer) |

*To browse multiple recorders, IE8 or higher version is required

Section 10: Spares List

Minitrend GR Recorder

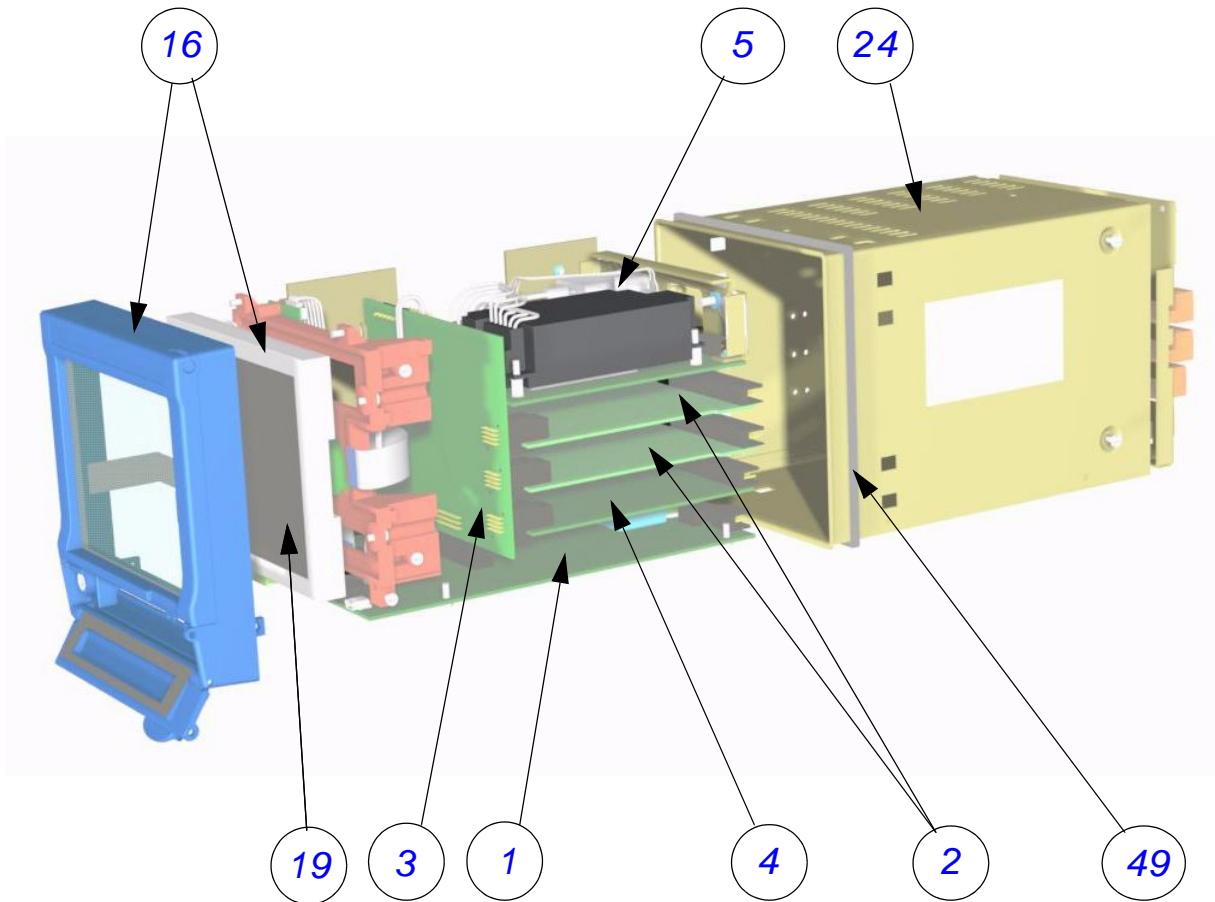

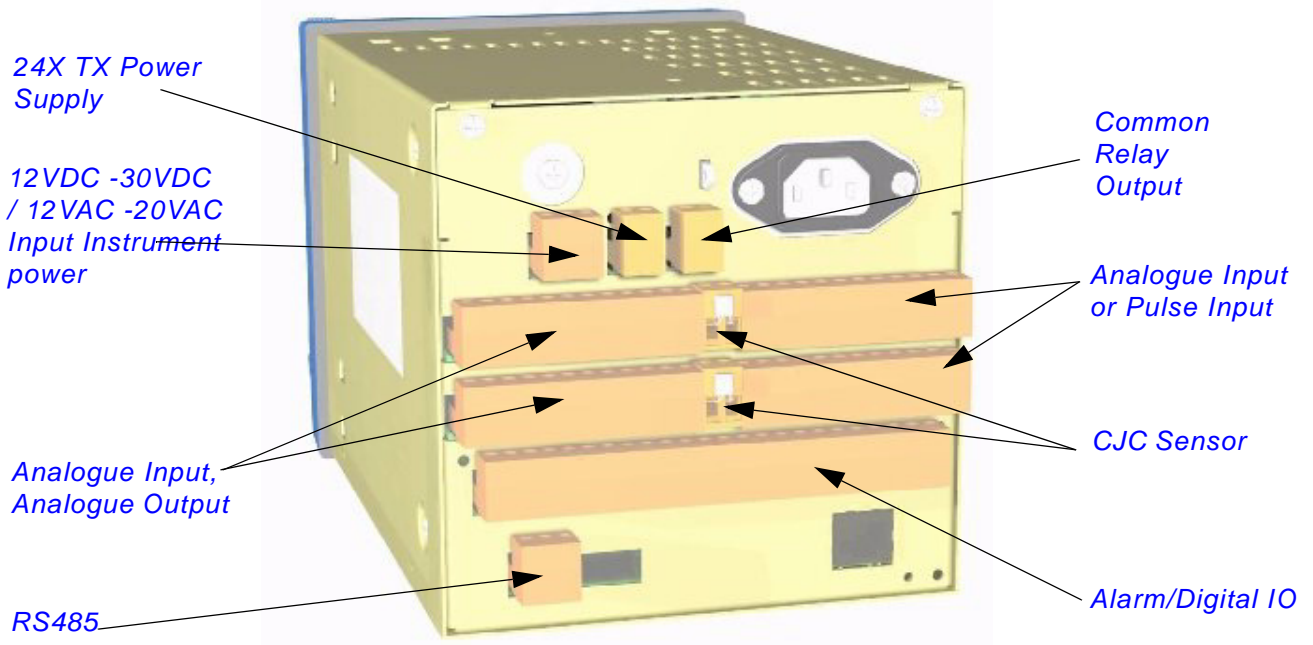
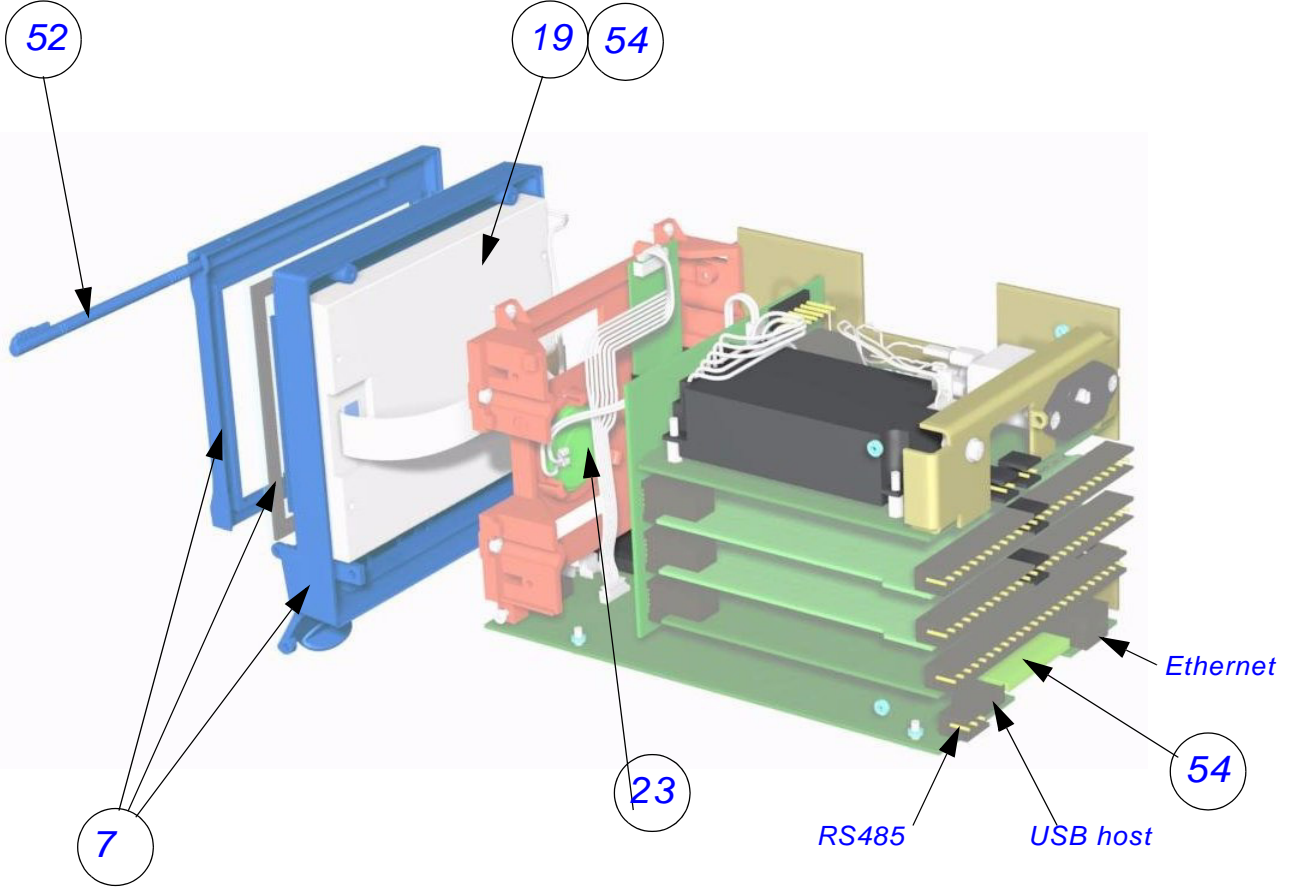

Table 10.1 :

| Minitrend GR - Spares | | | |
|------------------------------|--|---|---|
| 1 | 50071918-501 50071918-502 50071918-503 | Minitrend GR Processor 1GB SD Card Minitrend GR Processor 2GB SD Card Minitrend GR Processor 4GB SD Card | Note: Customer must supply model number and Serial number of existing unit when placing and order for processor board kits. |
| 2 | 51453006-501 51453006-502 51453006-503 | Minitrend GR Analogue Input 4CH Assy Minitrend GR Analogue Input 6CH Assy Minitrend GR Analogue Input 8CH Assy | |
| 2 | 51453027-501 51453027-502 | Minitrend GR Analogue Output 2CH Assy Minitrend GR Analogue Output 4CH Assy | |
| 2 | 50001017-502 | Minitrend GR Pulse Input 4CH Assy | |
| 3 | 51453009-501 | Minitrend GR Mother Board Assy | |
| 4 | 51453018-501 51453018-502 | Minitrend GR Digital I/O 8CH Assy Minitrend GR Digital I/O 16CH Assy | |
| 4 | 51453021-501 51453021-502 | Minitrend GR Relay Alarm 4CH Assy Minitrend GR Relay Alarm 8CH Assy | |
| 5 | 51453015-501 51453015-502 51453015-504 | Minitrend GR Power Supply AC Mains Minitrend GR Power Supply AC/TX Minitrend GR Power Supply 12VDC - 30VDC / 12VAC -20VAC | |
| 7 | 50083235-501 50082335-504 50083235-503 | Minitrend GR 5.7 Black Display Touch Screen Assy Minitrend GR Grey 5.7 Display Touch Minitrend GR QX RAL7032 5.7 Display Touch Screen Assy | |
| 16 | 50083254-501 50082354-504 50083254-503 | Minitrend GR Black Bezel Touch Screen Assy Minitrend GR Grey Bezel Touch Screen Assy Minitrend GR QX/QXE RAL7032 BEZEL TOUCH SCREEN ASSY | |
| 19 | 50081202-501 50084219-501 | Minitrend GR 5.7" Display & Cable 5.7" LVDS Display Cable | |
| 23 | 50001782-501 | Minitrend / Multitrend GR Speaker | |

Table 10.1 :

| Minitrend GR - Spares | | | |
|------------------------------|--|--|-----------|
| 24 | 51453071-501 | Minitrend GR Case and Back Plate Assy | |
| 28 | 50006787-501 | Minitrend GR / Multitrend GR Battery (Kit of 5) | |
| 29 | 50086626-505 | 8GB External SD memory card | Not shown |
| 43 | 51453071-502 | Minitrend GR Case, Handle and Terminal Cover | Not shown |
| 44 | 50005224-501 | Minitrend GR Rear Terminal Cover | Not shown |
| 48 | 30755050-502 | Minitrend GR Mounting Hardware kit (2 Mounting Brackets) | Not shown |
| 49 | 51453083-501 | Minitrend GR Panel Gasket | |
| 52 | 51453038-501 | Stylus Kit (pack of 5) | |
| 53 | 50013947-501 | Connector kit (2 of each connector type) | Not shown |
| 54 | 50086625-502 50086625-503 50086625-504 | 1GB GR INTERNAL SD MEM. CARD 2GB GR INTERNAL SD MEM. CARD 4GB GR INTERNAL SD MEM. CARD | |
| | 50017290-501 | Touch Screen Protector (kit of 5) | Not shown |
| | 46184161-502 | Carrying Handle kit | Not shown |
| | 50017181-501 | Minitrend GR/Multitrend GR Blanking Plate for I/O Slots (2) | Not shown |
| | 51452129-501 | 10 Ohm Resistors Pack of 8 | Not shown |
| | 50001251-501 | Minitrend GR Portable Case | Not shown |
| | 51453051-501 | Minitrend , Multitrend GR and eZtrend GR Power cord (250V AC) | Not shown |

Minitrend GR Portable Case Dimensions

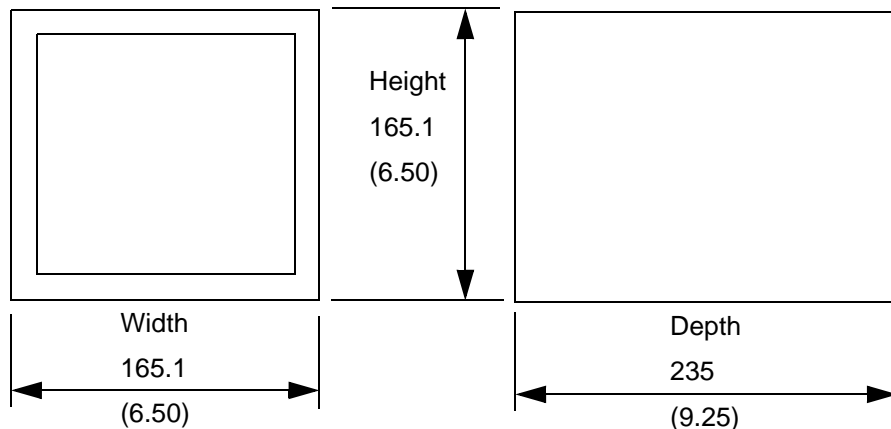

Multitrend GR Recorder

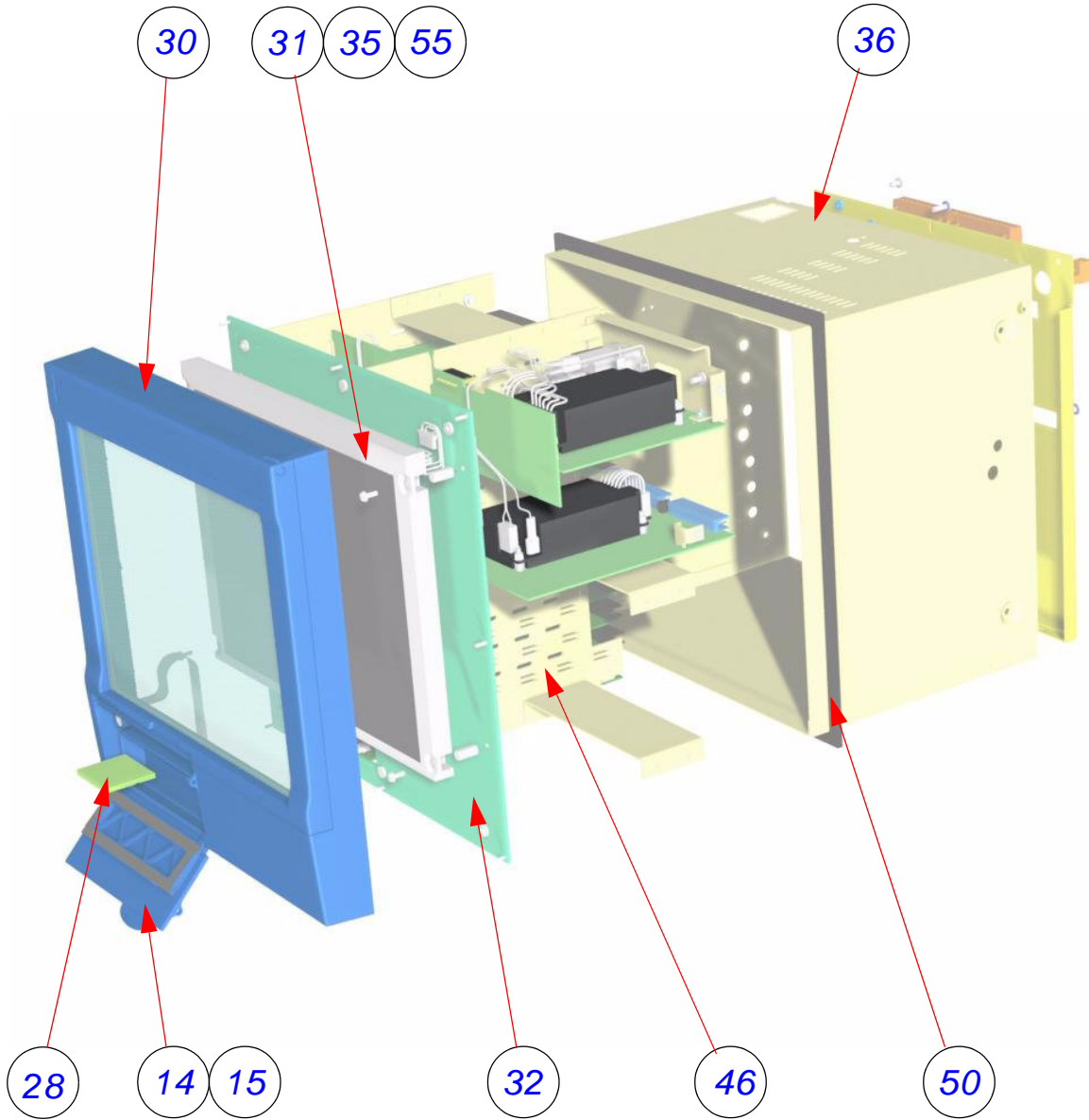

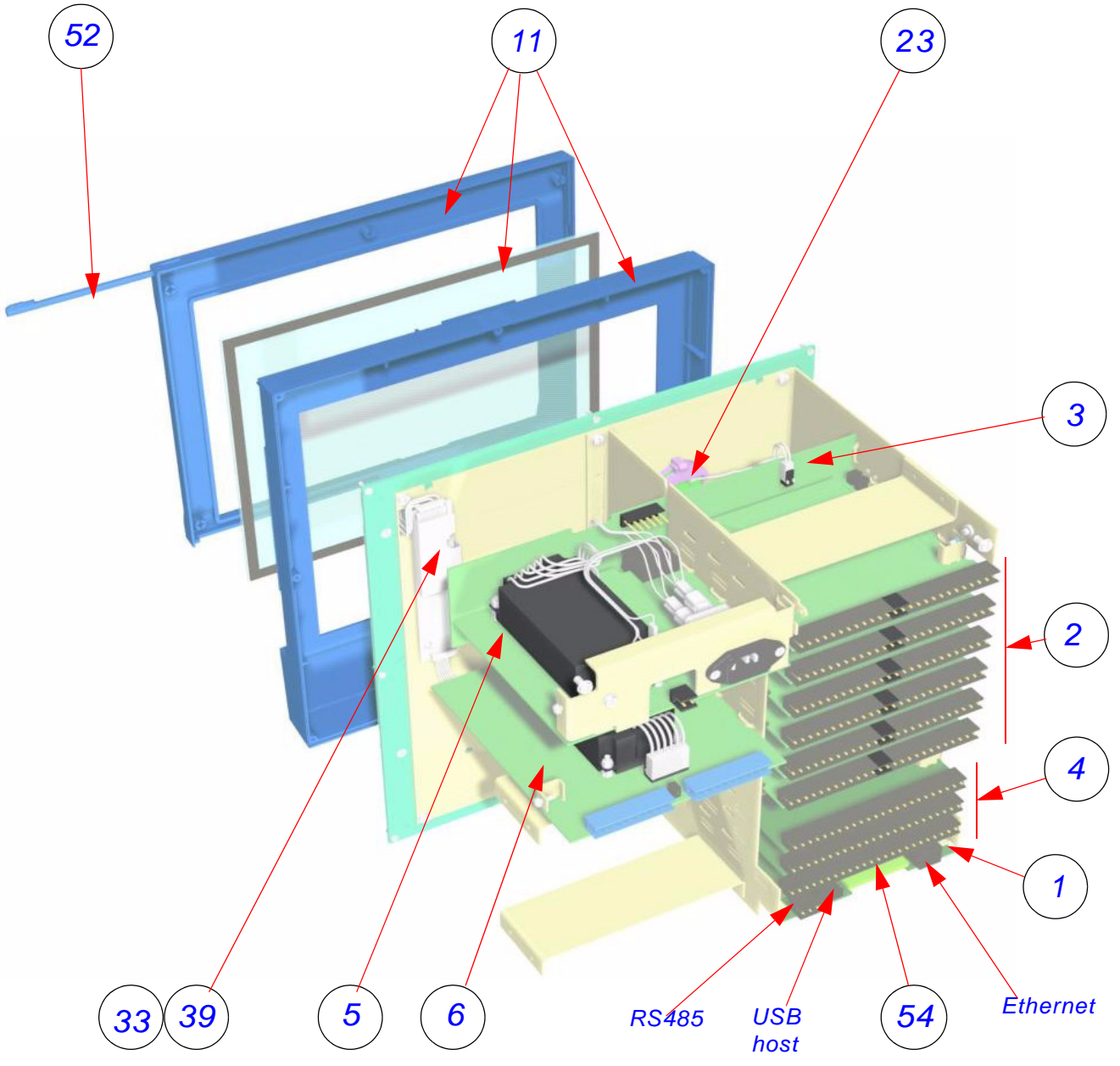

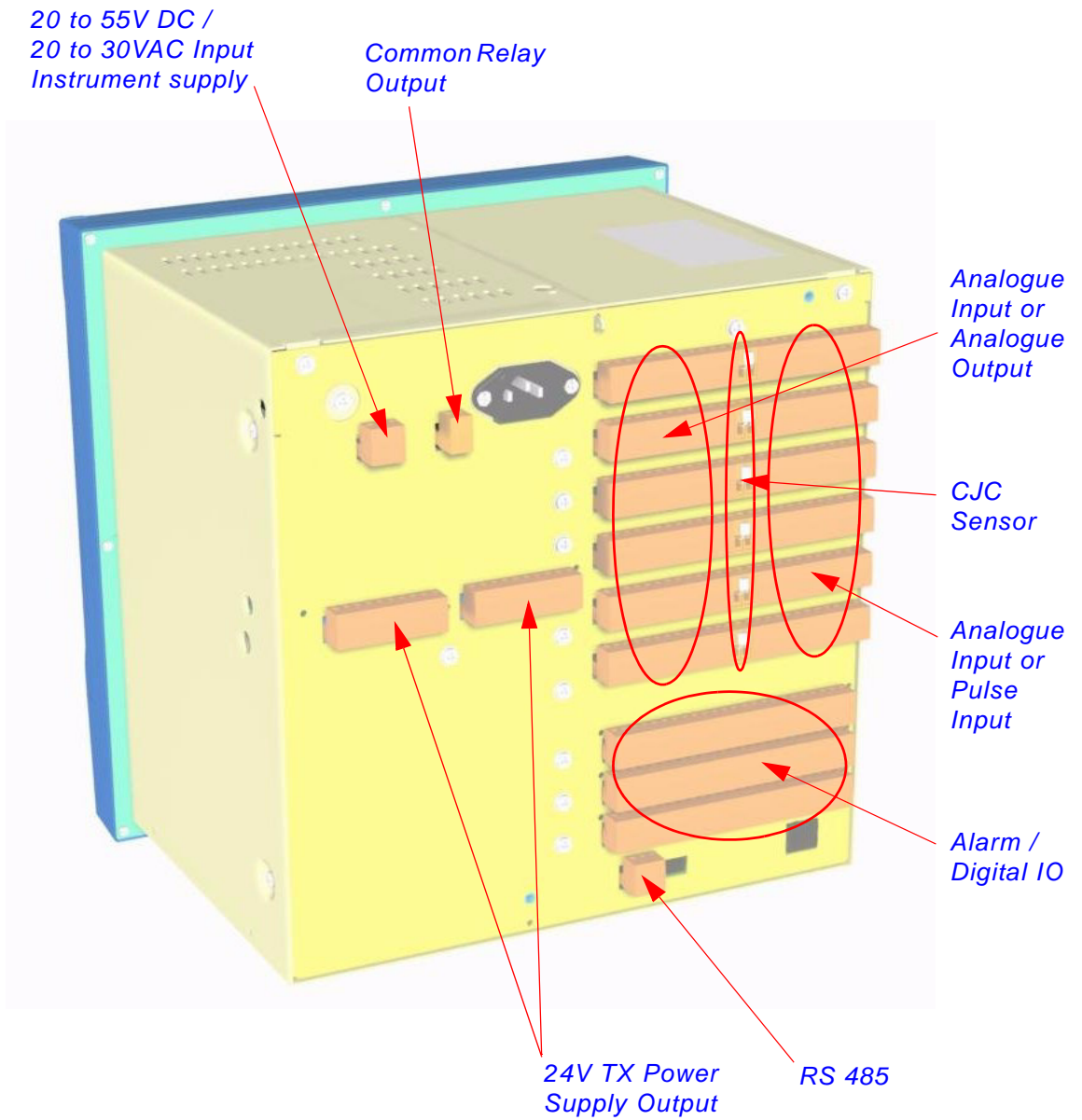

Table 10.2 :

| Multitrend GR - Spares | | | |
|-------------------------------|--|--|---|
| 1 | 50071918-501 50071918-502 50071918-503 | Multitrend GR Processor 1GB SD Card Multitrend GR Processor 2GB SD Card Multitrend GR Processor 4GB SD Card | Note: Customer must supply model number and Serial number of existing unit when placing and order for processor board kits. |
| 2 | 51453006-501 51453006-502 51453006-503 | Multitrend GR Analogue Input 4CH Assy Multitrend GR Analogue Input 6CH Assy Multitrend GR Analogue Input 8CH Assy | |
| 2 | 51453027-501 51453027-502 | Multitrend GR Analogue Output 2CH Assy Multitrend GR Analogue Output 4CH Assy | |
| 2 | 50001017-502 | Multitrend GR Pulse Input 4CH Assy | |
| 3 | 51453024-501 | Multitrend GR Mother Board Assy | |
| 4 | 51453018-501 51453018-502 | Multitrend GR Digital I/O 8CH Assy Multitrend GR Digital I/O 16CH Assy | |
| 4 | 51453021-501 51453021-502 | Multitrend GR Relay Alarm 4CH Assy Multitrend GR Relay Alarm 8CH Assy | |
| 5 | 50001182-501 50001182-502 | Multitrend GR Power Supply AC Mains Multitrend GR Power Supply 20-55VDC/20-30VAC | |
| 6 | 51453030-501 | Multitrend GR Transmitter Power Supply board | |
| 11 | 50084844-501 50084844-504 50084844-503 | Multitrend GR Black Display Assy Multitrend GR Grey Display Assy GR SX RAL7032 MULTITREND DISPLAY ASSY | |
| 14 | 50003590-504 | Multitrend GR Std Nema3 Door | |
| 15 | 50009119-504 | Multitrend GR Nema4/IP66 Door | |
| | | | |

Table 10.2 :

| Multitrend GR - Spares | | | |
|-------------------------------|--|---|---|
| 23 | 50001782-501 | Minitrend GR / Multitrend GR Speaker Assy | |
| 27 | 50006787-501 | Minitrend GR / Multitrend GR Bat- tery (kit of 5) | Not shown |
| 28 | 50086626-505 | 8GB External SD memory card | Not shown |
| 30 | 50084843-501 50084843-504 50084843-503 | Multitrend GR Black Touch Screen Assy Multitrend GR Grey Touch Screen Assy GR SX RAL7032 MULTITREND TOUCH SCREEN ASSY | Includes Bezel, Touch Screen and Display |
| 31 | 50084213-501 | Multitrend GR XGA 12.1" Display | |
| 36 | 51453098-501 | Multitrend GR Case and Back Plate | |
| 39 | 50084218-501 50084214-501 | Multitrend GR Inverter Multitrend GR LVDS Cable kit | |
| 42 | 50005458-501 | Multitrend GR Rear Terminal Cover kit | Not shown |
| 46 | 51453095-501 | Multitrend GR Chassis kit | |
| 50 | 50000871-501 | Multitrend GR Panel Gasket | |
| 51 | 50004292-501 | Multitrend GR Panel Clamp Assy (Qty 2) | Not shown |
| 52 | 51453038-501 | Stylus Kit Black (pack of 5) | |
| 53 | 50013947-501 | Connector kit (2 of each connector type) | Not shown |
| 54 | 50086625-502 50086625-503 50086625-504 | 1GB GR INTERNAL SD MEM. CARD 2GB GR INTERNAL SD MEM. CARD 4GB GR INTERNAL SD MEM. CARD | |
| | 50017290-502 | Multitrend GR Screen Protector (Kit of 5) | Not shown |
| | 46184161-502 | Carrying Handle kit | Not shown |
| | 51452129-501 | 10 Ohm Resistors Pack of 8 | Not shown |
| | 50017181-501 | Minitrend GR/Multitrend GR Blanking Plate for I/O Slots (2) | Not shown |
| | 50001249-501 | Multitrend GR Portable Case | Not shown |
| | 51453051-501 | Minitrend GR, Multitrend GR and eZtrend Power cord () | Not shown |

Multitrend GR Portable Case

Dimensions

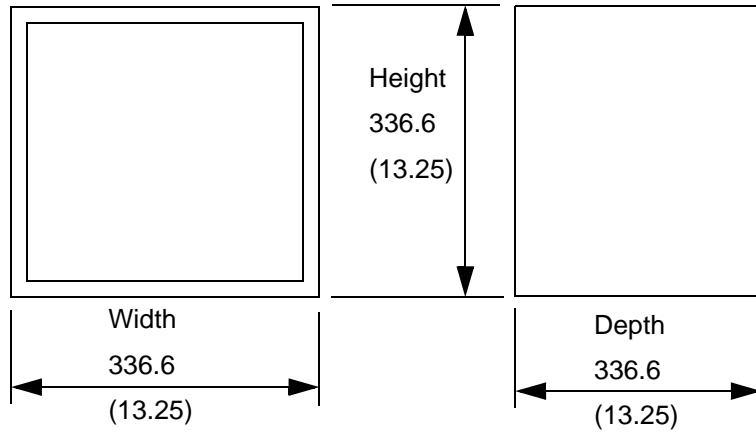

eZtrend GR Recorder

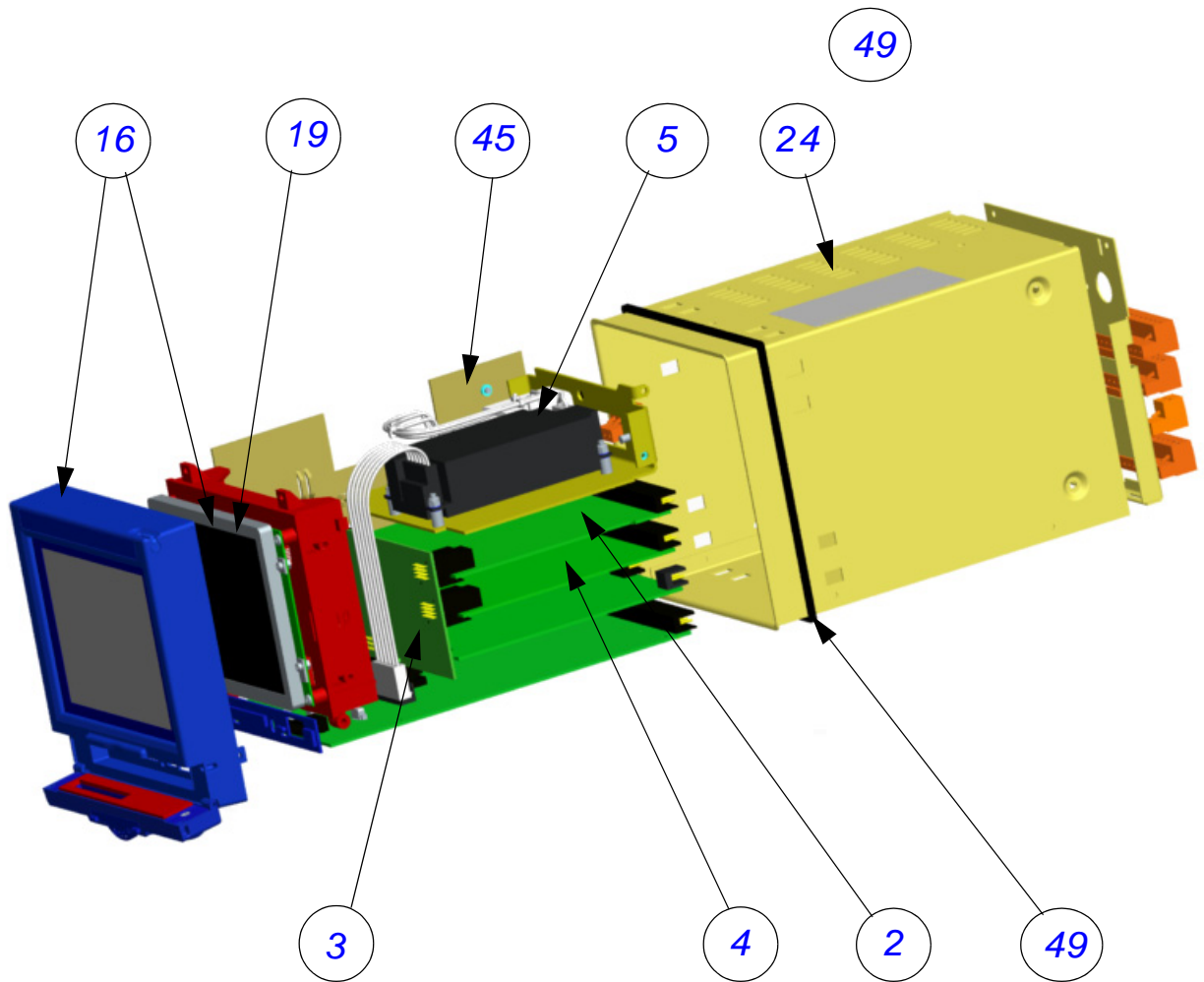

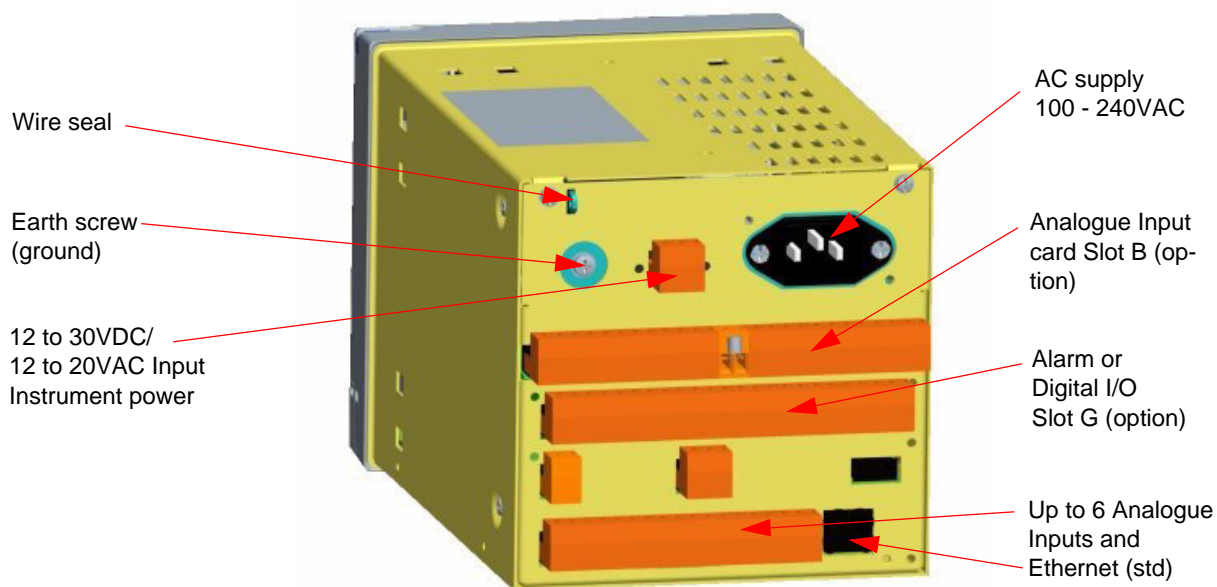
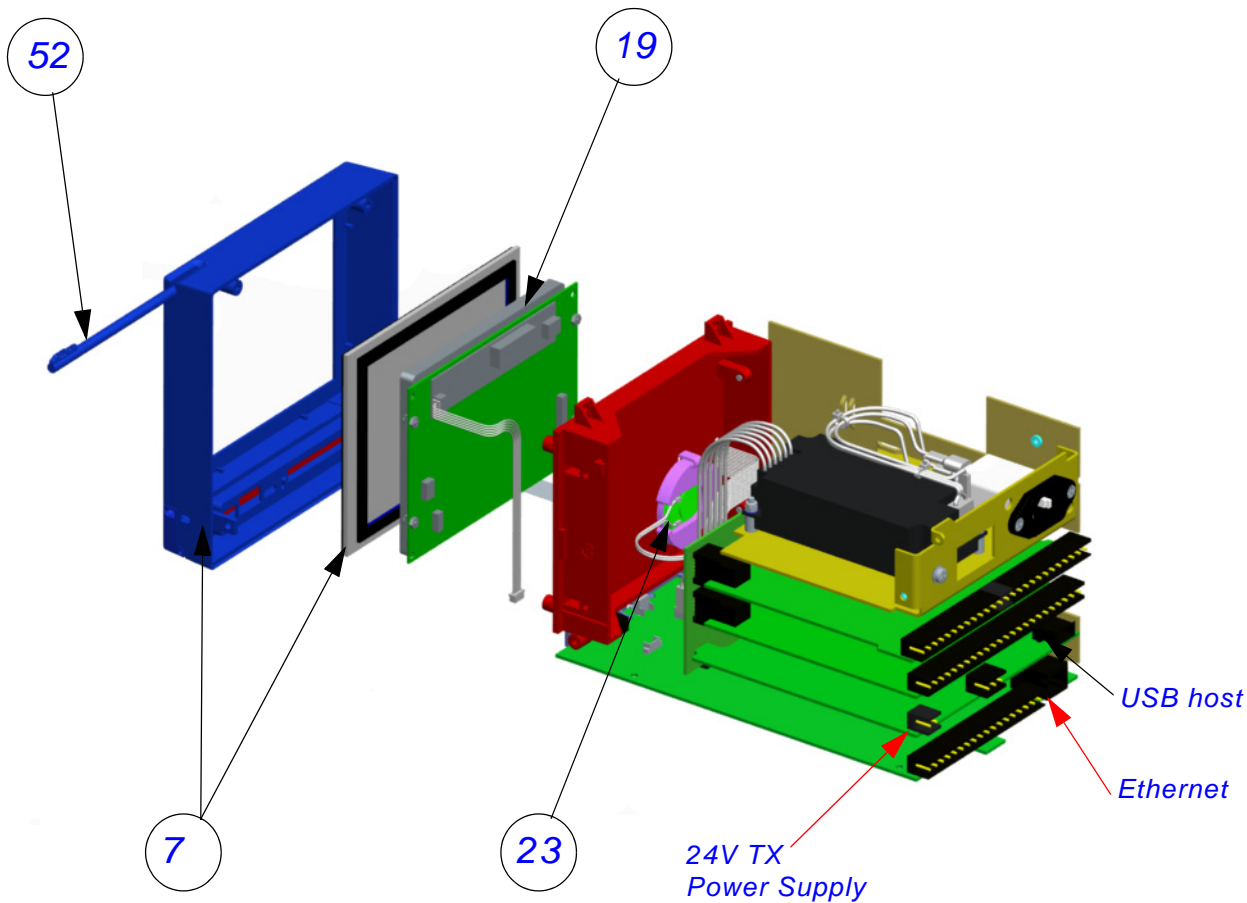

Table 10.3 :

| eZtrend GR - Spares | | | |
|---------------------|--|---|--------------------------------|
| 1 | 50071921-501 50071921-502 50071921-507 50071921-508 | eZtrend GR 3CH Processor 1GB eZtrend GR 3CH Processor 2GB eZtrend GR 6CH Processor 1GB eZtrend GR 6CH Processor 2GB | Credit Option only |
| 2 | 51453006-502 | eZtrend GR Analogue Input 6CH Assy | Requires Expansion card item 3 |
| 3 | 50012927-501 | eZtrend GR Expansion Board Assy | Required for items 2, 4 and 6 |
| 4 | 51453018-501 | eZtrend GR Digital I/O 8CH Assy | |
| 4 | 51453021-501 51453021-502 | eZtrend GR Relay Alarm 4CH Assy eZtrend GR Relay Alarm 8CH Assy | |
| 5 | 51453015-505 51453015-504 51453015-502 | eZtrend GR Power Supply AC Mains eZtrend GR Power Supply 12V/ 30VDC/12-20VAC eZtrend GR Power Supply AC Mains with TX Power | |
| 7 | 50083237-501 50083237-504 | eZtrend GR 5.7 Black Display Touch Screen Assy eZtrend GR 5.7 Grey Display Touch Screen Assy | |
| 16 | 50083254-501 50082354-503 50083254-504 | eZtrend GR Black Bezel Touch Screen Assy eZtrend GR RAL7032 BEZEL TOUCH SCREEN ASSY eZtrend GR Grey Bezel | |
| 19 | 50081204-501 50059722-501 | eZtrend GR 5.7" QVGA Display 5.7 EZ QVGA DISPLAY CABLE | |
| 23 | 50001782-501 | eZtrend GR/Minitrend GR/Multi-trend GR Speaker | |
| 24 | 50012896-501 | eZtrend GR Case and Back Plate Assy | |
| 27 | 50015474-501 | eZtrend GR Back Plate | |
| 28 | 50006787-501 | eZtrend GR/Minitrend GR/Multi-trend GR Battery (Kit of 5) | Not shown |
| 29 | 50086626-505 | 8GB External SD memory card | Not shown |
| 43 | 50012896-502 | eZtrend GR Case, Handle and Terminal Cover | Not shown |
| 44 | 50012915-501 | eZtrend GR Rear Terminal Cover | Not shown |

Table 10.3 :

| eZtrend GR - Spares | | | |
|----------------------------|------------------------------|--|-----------|
| 45 | 50020664-501 | eZtrend GR Left & Right Hand Chassis kit | |
| 48 | 30755050-502 | eZtrend GR Mounting Hardware kit (2 Mounting Brackets) | Not shown |
| 49 | 51453083-501 | eZtrend GR Panel Gasket | |
| 52 | 51453038-501 | Stylus Kit (pack of 5) | |
| 53 | 50021404-501 | Connector kit (2 of each connector type) | Not shown |
| 54 | 50086625-502 50086625-503 | 1GB GR INTERNAL SD MEM. CARD 2GB GR INTERNAL SD MEM. CARD | |
| | 50017290-503 | Touch Screen Protector (kit of 5) | Not shown |
| | 46184161-502 | Carrying Handle kit | Not shown |
| | 50017181-501 | eZtrend GR/Minitrend GR/Multi-trend GR Blanking Plates | Not shown |
| | 51452129-501 | 10 Ohm Resistors Pack of 8 | Not shown |
| | 50001251-501 | eZtrend GR Portable Case | Not shown |
| | 51453051-501 | Minitrend GR, Multitrend GR and eZtrend GR Power cord (250V AC) | Not shown |

Minitrend and eZtrend GR Portable Case

Dimensions

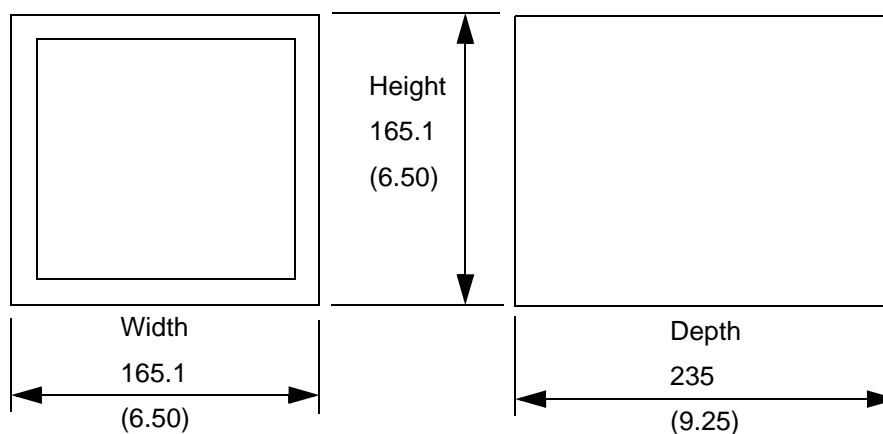

DR Graphic Recorder

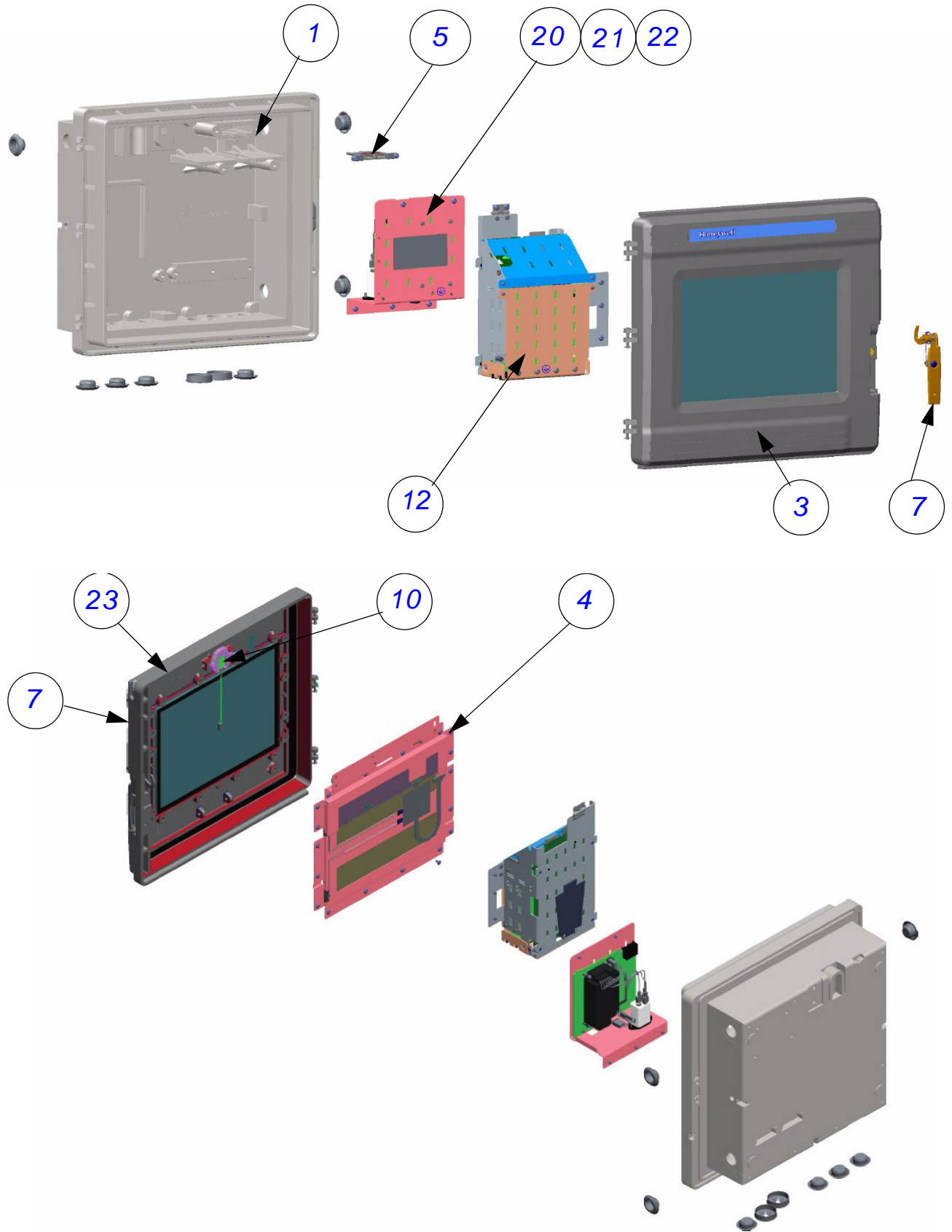

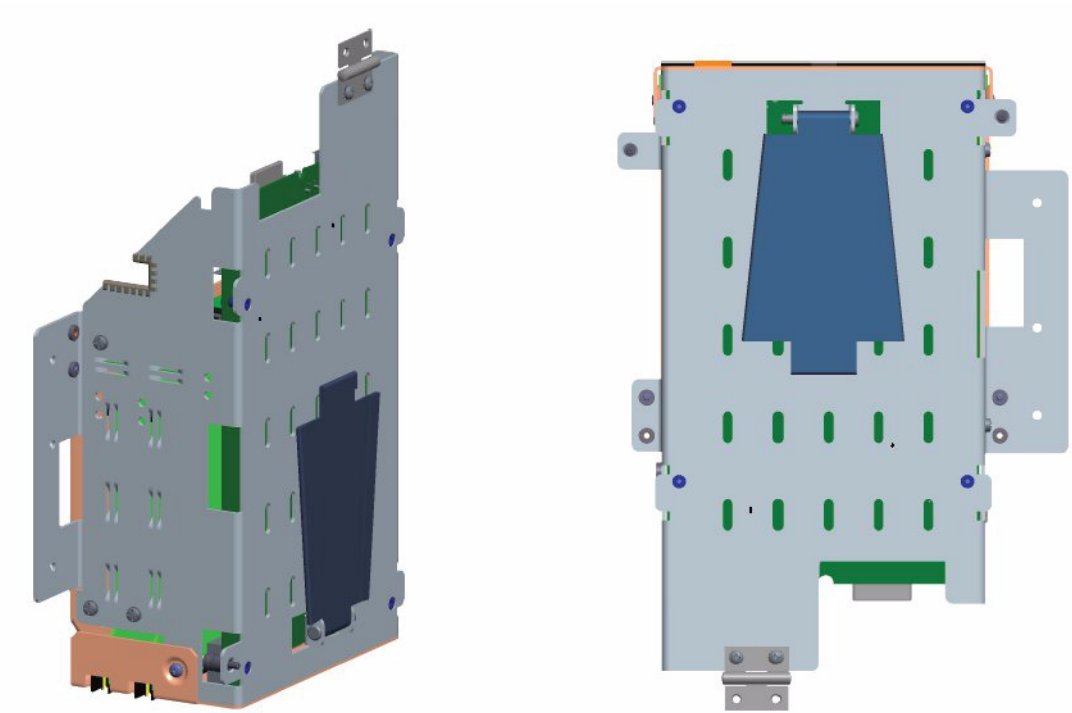
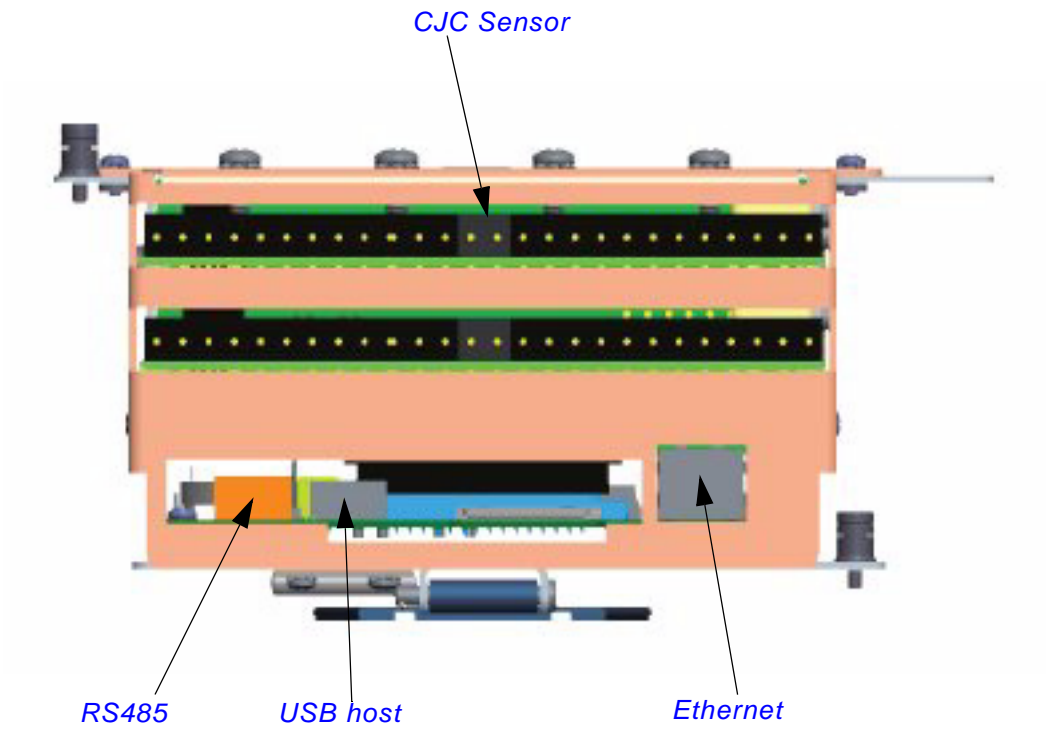

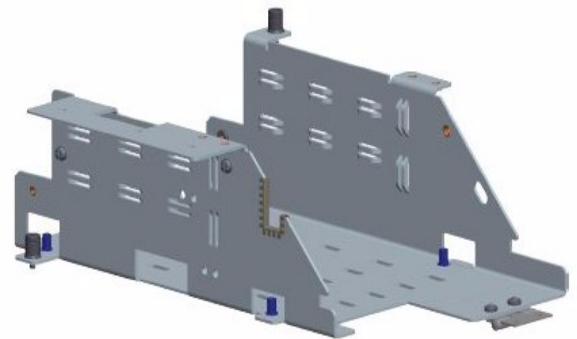
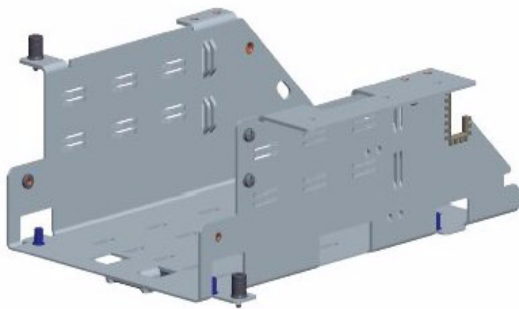
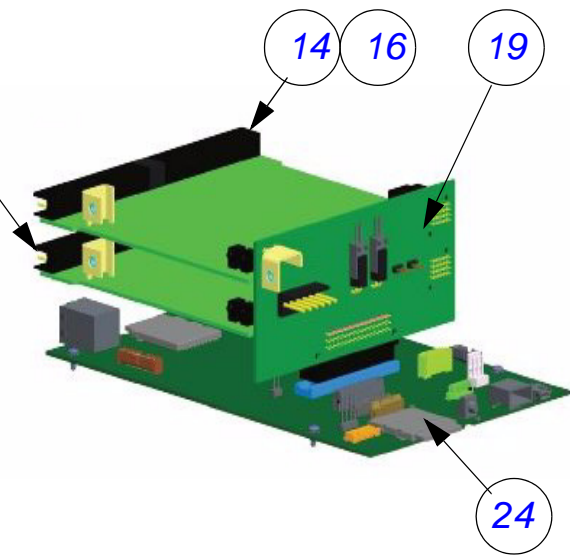
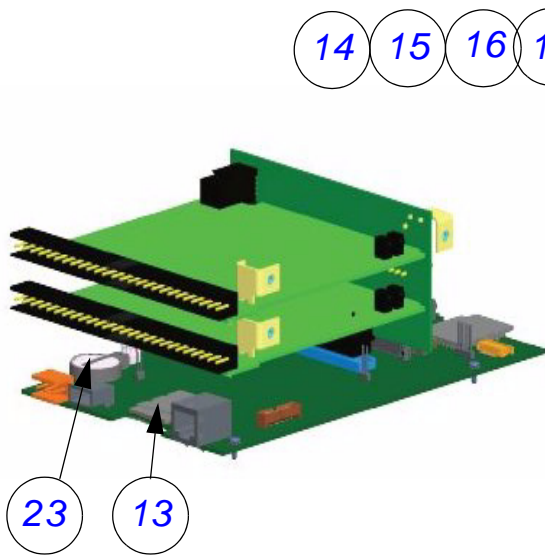
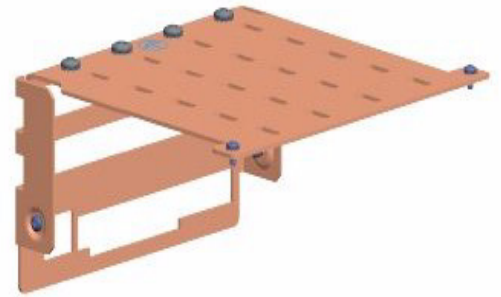

Table 10.4 :

| DR Graphic Recorder- Spares | | | |
|------------------------------------|--|---|---|
| 1 | 50099056-501 | Case & latch Assy | Includes case, latch bracket, screws, split lock washer and latch pin. |
| 2 | 32300506-501 | Door Assembly (without display) | Bezel and Touch Panel Assembly |
| 3 | 50092996-501 | Door Assembly | Bezel 12.1", Touch Panel Assembly, Speaker and Display |
| 4 | 32300081-501 | Display Kit | 12.1" Display with Cable assembly and display bracket |
| 5 | 50098928-501 | USB Cable Extender | |
| 6 | 32304412-501 | Misc Hardware | Hinge Pin, Circlip, Conduit Plugs – 2 Nos, Cord Bushing (Not Shown) |
| 7 | 32304395-501 | Door Handle & Latch Kit | Includes latch assembly parts. |
| 8 | 30755065-501 | Mounting Bracket Kit – Standard | |
| 9 | 30755065-502 | Mounting Bracket Kit (NEMA 4) | |
| 10 | 32304373-501 | Speaker Kit | Speaker and its Retainer |
| 11 | 32304377-501 | Cables Kit | Earth Braid, GPIO, DC LOOM Assy, LVDS Cable, BL Cable, RTP Extension Cable (Not Shown) |
| 12 | 32304379-501 | Chassis kit | Plate Base, Chassis Shallow Case Recorder Cover Front, Chassis Shallow Case Recorder Stand, Chassis Shallow Case Recorder Hinge Pin Circlip Cover Top, Chassis Shallow Case Recorder |
| 13 | 50071918-501 50071918-502 50071918-503 | Processor 1GB SD Card Processor 2GB SD Card Processor 4GB SD Card | Note: Customer must supply model number and Serial number of existing unit when placing an order for processor board kits. |
| 14 | 51453006-501 51453006-502 51453006-503 | Analogue Input 4CH Assy Analogue Input 6CH Assy Analogue Input 8CH Assy | |
| 15 | 51453027-501 51453027-502 | Analogue Output 2CH Assy Analogue Output 4CH Assy | |

Table 10.4 :

| DR Graphic Recorder- Spares | | | |
|------------------------------------|------------------------------|--|-----------|
| 16 | 50001017-502 | Pulse Input 4CH Assy | |
| 17 | 51453018-501 51453018-502 | Digital I/O 8CH Assy Digital I/O 16CH Assy | |
| 18 | 51453021-501 51453021-502 | Relay Alarm 4CH Assy Relay Alarm 8CH Assy | |
| 19 | 50098156-501 | Backplane Board Assy | |
| 20 | 50001182-503 | AC Power Supply | |
| 21 | 50001182-504 | AC Power Supply with Transmitter Power Supply | |
| 22 | 50001182-505 | 24VDC Power Supply | |
| 23 | 50006787-501 | Battery (kit of 5) | |
| 24 | 50086626-505 | 8GB External SD memory card | |
| 25 | 51453038-501 | Stylus Kit Black (pack of 5) | |
| 26 | 50013947-501 | Connector kit (2 of each connector type) | Not shown |
| 27 | 51452129-501 | 10 Ohm Resistors Pack of 8 | Not shown |
| 28 | 51453051-501 | Power cord (250V AC) | Not shown |
| 29 | 50020410-507 | 2GB USB Pen Drive | Not shown |



Section 11: Instrument Care and Maintenance

Instrument Care and Maintenance

The **GR Series** range of recorders contains no parts serviceable by the user, except for a fuse on the DC power supply, see [“Fuses” on page 22](#).

In the event of a recorder failure contact your nearest Service Department (or an authorised agent) to arrange for the return of the unit for repair.

Cleaning Instructions

The recorder's touch screen can be temporarily disabled for cleaning, see [“Clean Screen” on page 179](#).

Cleaning the unit should be done with a soft lint cloth and warm soapy water or screen cleaner recommended for use on a PC. Solvents and prolonged exposure to detergents can cause damage to the front panel. It is recommended that any cloth used for cleaning is damp but NOT wet, to avoid water collecting in the unit.

For Nema 4X /IP66 rated recorders (option) refer to the Nema 4X standards.

Backlights

1. MTTF (Mean Time To Fail) is defined as the time at which 50% of a batch of backlights remain in excess of half their original brightness i.e. a display has a greater than 50% chance of being half its original brightness when used at 100% after:
 - 55,000 hrs for the **Minitrend GR**. Maximum luminosity 400 cd/m², (86,000hr if used at 80%).
 - 43,000 hrs for the **Multitrend GR** and **DR Graphic**. Maximum luminosity 400 cd/m², (67,000hr if used at 80%).
 - 40,000 hrs for the **eZtrend GR**. Maximum luminosity 450 cd/m², (62,500hr if used at 80%). For this recorder the backlight cannot be changed separately so the display has to be replaced.

Reducing the brightness can significantly improve the life of the backlight.

2. At extended temperatures these times are reduced.
3. The backlight is a consumable item, and will NOT last forever.
4. A maintenance schedule of exchanging backlights should be every 5 years to maintain the optimal screen clarity.

Operating Temperature

Operating temperatures are described in [“Specification Tables” on page 307](#). Prolonged operation at temperatures over 50 °C will accelerate degradation of the display backlight.

If the unit has been moved from a cold environment into a warm one, ensure that the unit has reached a minimum temperature of 12 °C or is left to stand for 1 hour at room temperature before applying power, to ensure no condensation remains in the unit.

Touch Screen

Care should be taken with the touch screen when handling the unit. Sharp and hard objects may pierce the touch screen and damage the display. Only use the stylus provided for screen selection.

Clean the screen using a suitable touch screen cleaner. Abrasive materials will damage the touch screen.

Protective Screen covers are available to provide additional protection against abrasive materials. [See “Section 10: Spares List” on page 281.](#)

Calibration

It is recommended that Recorder calibration is checked at least every year, or in accordance with your industry regulations, to ensure maximum accuracy. [See “Calibration” on page 132.](#)

Field IO Specification

Analogue Output

(Not available for the **eZtrend GR** recorder)

Each recorder is capable of supporting analogue output function. The AO card is available as a 2 or 4 channel option, and will plug into any of the analogue input slots.

Analogue Outputs are used to support:

- Re-transmission of Analogue Input values
- Re-transmission of Math Results
- Re-transmission of Process values
- Control Outputs

Analogue Output Specifications

- Resolution - 0.002% or better
- Accuracy - +/- 0.1% 0-500ohm load, +/- 0.25% 500ohm - 1Kohm load
- Maximum load resistance - 1Kohm
- Isolation - 300V AC
- Outputting - 0 to 20mA or 4 to 20mA (over range capability to 21mA)
- Update rate - 250mSec per channel

Pulse Input Card

The Pulse Card is available as an option, and will fit in slots normally allocated to AI cards. The frequency output from the card can be used in a Maths block and is represented by HPULn (where 'n' is from 1 to 4, when the card is fitted in the top slot)

- Frequency - 1 Hz to 25kHz, this will update once per second
- Inputs - 4 x isolated inputs.

A separate Pulse input card is not available for the **eZtrend GR** recorder, however the first 4 inputs on the Digital I/O card (option) can be used as pulse inputs.

Analogue Input

User Defined Maximum Input Ranges

For values entered for the Range Type in the *“Analogue In Menu” on page 73.*

Table 12.1 : Analogue In Ranges

| Preset Ranges | Maximum Voltages | Preset Ranges | Maximum Voltages |
|----------------------|-------------------------|----------------------|-------------------------|
| 50V | 52V | 1000mV | 1.1V |
| 25V | 26V | 500mV | 600mV |
| 12V | 13V | 250mV | 300mV |
| 6V | 6.5V | 100mV | 150mV |
| 3V | 3.25V | 50mV | 75mV |
| 1.5V | 1.6V | 25mV | 36mV |
| 0.6V | 0.8V | 10mV | 18mV |
| 0.3V | 0.4V | 5mV | 9mV |

Relay Alarm/Digital Input Specification

Minitrend GR, eZtrend GR and DR Graphic recorders have one ‘slot’ for digital inputs and alarm relay outputs. All alarm card channels provide 240V AC isolation channel to channel and channel to recorder. Digital I/O channels will provide isolation to 100V AC test voltage (not for mains connection).

The **Multitrend GR** recorder has three available expansion slots for Digital Input/Relay Alarm output cards.

Inputs are automatically debounced to remove switching oscillations. All Digital Inputs are volt free contacts, and are sampled at 10Hz max.

Relay/Alarm Output Card Options

There are two card options, split into two types:

4 Channel Relay Alarm Card

120/240 VAC 3 Amps rated (resistive load). The relay contacts are form C (NO, NC) and includes suppression.

8 Channel Relay Alarm Card

120/240V AC 3 Amps rated (resistive load). Two channels on the 8 Relay Alarm card, can be used as digital inputs. The relay contacts are form C (NO, NC) and includes suppression. The 8 & 2 Relay Alarm card, this 8-channel card will have 8 mains rated relays, of which 2 of the 8 channels can be configured for use as digital inputs.

Latched or Single Pulse

The relay outputs can be set by the user to be either Latched or Single Pulse.

Latched

A latched relay will maintain in its active state until the trigger source has returned to a non alarmed state, or a second Event has been activated to disable the relay.

Single Pulse

The relay will go active for a period of time, specified by the user, then return to a non active state. The time out period remains independent of the length of time the active state remains.

Single Pulse Relay Settings

User can specify Pulse length in seconds from 0.1 (100ms) to 6480 (108 minutes) in 0.1 second increments.

Fail Safe

Each relay channel can be independently selected with the fail safe option. This will invert the state of the relay output. With Failsafe Off normally open (NO) relays have open contacts when the power is off, and open contacts when there is no active alarm. The contacts will close when an associated alarm goes active. With Failsafe On, normally open relays have closed contacts when the recorder is powered on and there are no open active alarms, and the contacts open with an alarm active or when the power is removed. [See “Failsafe Relay Positions” on page 306.](#)

Relay Output Specification

The **Minitrend GR** recorder will provide the ability to have at least 1 relay output for each analogue input (i.e. 16). **Multitrend GR** recorder will also provide at least one relay output for each analogue input (i.e. 48), there are three available slots for Digital inputs/ Relay Outputs. Up to 8 relay outputs are available for the **eZtrend GR** and **DR Graphic** recorder.

Common Alarm Output

The common alarm output include a single alarm relay. This relay is the same rating as those on the 8 & 16 Digital I/O cards. This relay is NC (normally closed) and can be activated by any alarm. This relay will close when power is removed. This relay is identified as “Fixed” in the relay output pick lists.

- Rating - 24Vdc 1A Resistive Load

Digital Input Cards

Three options for digital inputs are available

8 Digital Inputs

8 Digital I/O card, this 8-channel card allows the user to configure each channel to be either relay output or digital input. Relay output rated at 24V DC 1 Amp rated (resistive load).

16 Digital Inputs

Relay Alarm/Digital Input Specification

(Not available for the **eZtrend GR** recorder)

16 Digital I/O card, this 16-channel card allows the user to configure each channel to be either relay output or digital input. Relay output rated at 24V DC 1 Amp rated (resistive load).

Digital Input Functions

The digital inputs can be used for the following actions;

- A Digital contact on an input can be used to enable or disable one or any combination of alarms
- Can be used in Maths expressions
- Can have current status indicated on DPMs, Bars and Charts

Failsafe Relay Positions

Table 12.2 :

| eZtrend GR, Minitrend GR, Multitrend GR and DR Graphic Relay Positions (no alarms active) | | | |
|--|-----------|-----------|-----------|
| Normal Relay Output States | | NO | NC |
| | Power On | Open | Closed |
| | Power Off | Open | Closed |
| Failsafe Relay Output States | | NO | NC |
| | Power On | Closed | Open |
| | Power Off | Open | Closed |

AMS2750 Process Mode

Provides on-line monitoring in the process recorder to alert the user to potential AMS2750 non-compliance issues. Monitors and alerts the user concerning - days until next SAT, days until next TUS, days until next control T/C change out and days until the recorder requires calibration. The recorder also provides an overview of T/C usage for all survey T/C's providing a colour coded for early warning screen (5 day expiration).

AMS2750 TUS Mode

The **Multitrend GR** and **DR Graphic** recorder monitors a temperature uniformity survey and generates a data file that can be used to create a TUS report. It tracks a number of parameters during a TUS which includes the ramp time, the time between the first T/C entering dwell zone and the last T/C entering dwell zone, the point where all t/C's are stable and lie within the SP tolerance limits for the defined furnace class, the dwell time (minimum of 30 min.) for the survey, the maximum temperature value during the dwell period and the minimum temperature value during the dwell period. The on line TUS tracking screen shows the current status of a survey for up to 6 set points, furnace details, status, Min & Max TC readings, Max differences, Max Overshoot, durations and the Class of furnace the survey met.

Specification Tables

| Specification | Design Attributes |
|--|--|
| Digital indicators and Display | <p>Minitrend GR Recorder <i>Display size and Type:</i> 5.7" diagonal, Digital Colour LCD (TFT) with Touch Screen Industrial grade with brightness adjustment and wide viewing angle <i>Resolution:</i> VGA (640 x 480 pixels). <i>Screen Saver:</i> Set in minutes from 1 to 720, can be set to dim the screen or to switch off. <i>Brightness adjustment:</i> Adjustable between 10 and 100%, default set to 80% brightness. <i>Backlight life time:</i> 50,000 hours to half brightness when used at 100%, (62,500 hours with 80% brightness @ 25 deg). Maximum luminosity 400 cd/m². <i>Touch Screen life:</i> 1,000,000 touches</p> <p>Multitrend GR and DR Graphic Recorder <i>Display size and Type:</i> 12.1" diagonal, Digital Colour LCD (TFT) with Touch Screen Industrial grade with brightness adjustment and wide viewing angle <i>Resolution:</i> XGA (1024 x 768 pixels). <i>Screen Saver:</i> Set in minutes from 1 to 720, can be set to dim the screen or to switch off. <i>Brightness adjustment:</i> Adjustable between 10 and 100%, default set to 80% brightness. <i>Backlight life time:</i> 50,000 hours to half brightness when used at 100%, (62,500 hours with 80% brightness @ 25 deg). Maximum luminosity 400 cd/m². <i>Touch Screen life:</i> 1,000,000 touches</p> <p>eZtrend GR Recorder <i>Display size and Type:</i> 5.7" diagonal, Digital Colour LCD (TFT) with Touch Screen Industrial grade with brightness adjustment and wide viewing angle <i>Resolution:</i> QVGA (320 x 240 pixels). <i>Screen Saver:</i> Set in minutes from 1 to 720, can be set to dim the screen or to switch off. <i>Brightness adjustment:</i> Adjustable between 10 and 100%, default set to 80% brightness. <i>Backlight life time:</i> 50,000 hours to half brightness when used at 100%, (62,500 hours with 80% brightness @ 25 deg). Maximum luminosity 450 cd/m². <i>Touch Screen life:</i> 1,000,000 touches</p> |
| Display Update Rate | Display values updated every second |
| Status Display | A status bar, at the top of the recorder's screen, displays the real-time icons of the recorder status, such as Time left and alarm active. |
| Communications | Ethernet 10/100 base - T with RJ45 connector supporting Modbus/TCP, FTP, Internet, DHCP or fixed IP address. (RS485 not available for the eZtrend GR) |
| Mathematics | Basic maths include Add, Subtract, Multiply, Divide, Modulo and power. Full Maths and Scripting (option) support up to 100 character free form math expression for each pen. Like SINE, COS, TAN, Log, Parenthesis (eg. A1 + A2), comm variables, free memory, and access to any data item variable (A1, P1, D1 etc.). (Scripting is not available for the eZtrend GR). |
| Front and Rear USB Ports | USB host ports front and rear for data and setup transfers through these ports. External devices keyboard or mouse, Barcode reader, or external mass storage device. USB ports are internal for DR Graphic |
| Standard Screens and Custom Screens | Fully programmable display values in engineering units. Time & date stamp on every division, providing the current time and date. Sets of Standard screens are available to display data on a chart, digital reading, bargraphs or numerous combinations thereof. Screen properties can be modified on the recorder and customised to suit. Custom screens created in the Screen Designer software can be imported into the recorder for specialist applications. Custom Screen firmware option is required. Digital values displayed include alarms on bars, engineering units, pen name, tag, time and date, 20 character description and totalised values. (Custom Screens are not available as an option for the eZtrend GR) |

Relay Alarm/Digital Input Specification

| Specification | Design Attributes |
|-----------------------------------|---|
| Data Storage | <p><i>Removable Media:</i> SD card supports up to 8.0 Giga bytes. (SD card is available as an option for the eZtrend GR)</p> <p><i>Local Mass Storage Options:</i> USB memory key - no size restriction but must be formatted (FAT, FAT16, TFAT FAT32).</p> <p><i>Internal Data Buffer Minitrend GR, Multitrend GR and DR Graphic Recorder:</i> Non-volatile. 1GB upwards to 4GB</p> <p><i>Internal Data Buffer eZtrend GR Recorder:</i> Non-volatile. 1GB upwards to 2GB</p> <p><i>Setup and screens:</i> Stored internally on non-volatile memory</p> <p><i>Manual Saving:</i> Data saving by inserting SD card or USB memory stick</p> <p><i>Data Saving Period:</i> Related to log rate, number of pens, totals and alarms. Each pen is capable of its own independent storage rate.</p> <p>Minitrend GR and Multitrend GR Recorder: 20ms to 60h, eZtrend GR Recorder: 100mS to 60h.</p> <p><i>Data Format:</i> Honeywell binary encoded format</p> <p><i>Recycling Mode:</i> Internal memory has FIFO (First In First Out) capability where the newest data over-writes the oldest data.</p> |
| Power Requirements | <p>Minitrend GR Recorder <i>Voltage (VRMS):</i> 100VAC to 240VAC (auto select). Frequency: 50/60Hz <i>Inrush Current:</i> 75A max. (High Line, Cold Start) <i>Power Consumption:</i> <40W. <i>24V Optional instrument power:</i> 12VDC-30VDC /12VAC-20VAC. Power Consumption: < 40 watts 12VDC -30VDC / 12VAC -20VAC</p> <p>Multitrend GR <i>Voltage (VRMS):</i> 100VAC to 240VAC (auto select). Frequency: 50/60Hz <i>Inrush Current:</i> 75A max. (High Line, Cold Start) <i>Power Consumption:</i> AC: <50VA (max), DC: <60W (max). Typical 30W <i>24V Optional instrument power:</i> 20 to 55VDC/20 to 30VAC. Power Consumption: < 40 watts</p> <p>DR Graphic Recorders <i>Voltage (VRMS):</i> 100VAC to 240VAC (auto select). Frequency: 50/60Hz <i>Inrush Current:</i> 75A max. (High Line, Cold Start) <i>Power Consumption:</i> AC: <50VA (max), DC: <40W (max). Typical 25W <i>24V Optional instrument power:</i> 20 to 55VDC/20 to 30VAC. Power Consumption: < 40 watts</p> <p>eZtrend GR Recorder <i>Voltage (VRMS):</i> 100VAC to 240VAC (auto select). Frequency: 50/60Hz <i>Inrush Current:</i> 75A max. (High Line, Cold Start) <i>Power Consumption:</i> <40W. <i>24V Optional instrument power</i> 12 to 30VDC/12 to 20VAC. Power Consumption: < 40 watts</p> |
| Common Relay Output (SPNC) | NC common alarm relay: Two contacts, normally open when the recorder is powered (no active alarms). Rating 24V, 1 Amp. |
| Battery | Battery backed up for clock, replaceable Lithium battery Type CR6032, 3.0V – 10 years life (Recorder powered), 1 year life, typical (Recorder unpowered). |
| Password Protection | Multiple Administrator control of password setup and management with four levels of password protection for – Engineer, Supervisor, Technician, and Operator. Up to 50 different users are available. Password protection restricts user entry to the recorder set up and specific screens. Engineer – Highest access to all levels, Supervisor, Technician and Operator. Supervisor – 2nd highest level including Technician and Operator access Technician – 3rd level including Operator access Operator – 4th and lowest level of access. |
| Languages | English UK & US, French, German, Italian, Spanish, Brazilian, Polish, Hungarian, Slovakian, Czech, Turkish, Romanian, Russian, Greek, Portuguese and Bulgarian. Also Asian languages including Chinese (simplified), Japanese and Korean. |
| Temperature Units | °C, °F, °K |
| Recorder Identification | Status bar: Alternately displays Recorder ID and Recorder Screen Name. Displays Time and Date. |

Relay Alarm/Digital Input Specification

| Specification | Design Attributes |
|--|---|
| Clock | Accuracy: ± 20 ppm (± 1 minute/month) @ 25°C. Summer/Winter manual or automatic time adjustment or via communications. SNTP Client and/or Server included for synchronising over Ethernet. Recorder Time Synchronisation on Digital Input. |
| Alarm Set Points | 6 per pen integral "soft" alarm set points easily set by user to announce selected out of limit conditions; user can select if an alarm triggers a change in the screen background colour. Alarm triggers can be set for Hi, Lo, Deviation (latched or unlatched) for alarm acknowledgement. Alarm Damping – 1 sec to 3600 seconds; Hysteresis - +/- 100% of pen scale Common relay output: 1A 24V, can be activated on any alarm. (Not available for the eZtrend GR) |
| Data Replay Mode | Data replay facility on chart displays at normal, fast or slow speeds with zoom and cursor. |
| Display Chart Speeds | Chart rates: 1 mm/hour, 5 mm/hour, 10 mm/hour, 20 mm/hour, 30 mm/hour, 60 mm/hour, 120 mm/hour, 600 mm/hour, 1200 mm/hour, 6000 mm/hour. Combinations of rates can be mixed and chart speeds can be set independently for each chart. Display speeds are independent of logging rate |
| Messages Screen | The message screen displays system information and records any setup activity that has been changed. It also provides warning and error message updates, lists alarm activity and will display user defined marks on a chart. |
| CE Conformity (CE Mark) | This product conforms with the protection requirements of the following European Council Directives: 2006/95/EC, the Low Voltage Directive, and 2004/108/EC, the EMC Directive. Conformity of this product with any other "CE Mark" Directive(s) shall not be assumed. |
| Immunity Product Classification | Complies with EN61326-1:2013 Class I: Cord Connected, Panel Mounted Industrial Control Equipment with protective earthing (grounding). (EN 61010-1:2010) |
| Enclosure Rating | Front panel designed to NEMA 3R / IP55 for Multitrend GR only and NEMA 3/IP55 for Minitrend GR and eZtrend GR (Optional NEMA 4X / IP66) DR Graphic recorder (NEMA 4X), NEMA 3/IP55 std. Optional NEMA type 4X/IP66 |
| Installation Requirements | Category II: Overvoltage (EN 61010-1-2010) Pollution Degree 2 |
| EMC Standards | Emissions - EN61326-1:2013 Immunity - EN61326-1:2013 Industrial Levels |
| Safety | Complies with EN61010-1: 2010. Panel Mounted Equipment, Terminals must be enclosed within the panel. |

| Specification | Analogue Inputs |
|-----------------------------------|---|
| Number of Inputs | Minitrend GR & DR Graphic recorder can have 4, 6, 8, 12 or 16 input channels. Multitrend GR recorder can have 4, 6, 8, 12, 16, 24, 32, 40 or 48 input channels. eZtrend GR recorder can have 3, 6, 9 or 12 input channels. |
| Input Types | mV, V, mA with external shunt (provided as standard), Thermocouple, RTD and ohms |
| Minimum Input Span | Range is fully configurable with span limitation of the operating range selected with 4% under range to 4% over-range capability (50V Range 2%) |
| Burnout (T/C) | Active (High or Low), Passive, and Health watch/Maintenance (option). |
| Cold Junction Compensation | Internal compensation with the ability to manually adjust values, External Input for compensation, External CJC value specified |
| Input Resolution | 0.0015% (16 Bit ADC) |
| Input Impedance | Current loop resistance: 10 ohms, use $\pm 0.1\%$ external resistor. Volts $> 1M\Omega$, all other $> 10M\Omega$ |

Relay Alarm/Digital Input Specification

| Specification | Analogue Inputs |
|---|--|
| Source Impedance | T/C and RTD: 100 ohms per lead maximum (CU10 = 15 ohms, not available for the eZtrend GR) A single point cal on Slot A of the eZtrend GR recorder will improve accuracy for lead resistance above 10 ohms |
| Square Root Extraction | Available as standard on every input type |
| Sensor Compensation | Single point and Dual point |
| Input Sampling Rate | DR Graphic recorders Minitrend GR/eZtrend GR Recorder has 2 available slots and the Multitrend GR Recorder has 6 available slots with up to 8 analog inputs each; the input sampling rate is dependent on actuation type. DR Graphic/Minitrend GR/Multitrend GR: All Inputs: 100mS (10Hz), 200mS (5Hz), 500mS (2Hz) DR Graphic/Minitrend GR/Multitrend GR: Fast Sampling: 20mS (50Hz) - mA, mV, Ohms and Volts only eZtrend GR 200mS (5Hz), 500mS (2Hz) and 100mS (10Hz) (Analogue Input expansion card option) |
| Scales, Linear & Logarithmic | Normal and Scientific notation Decimal Point automatic or programmable Engineering units, user definable (10 characters) Logarithmic: -38 min, to +38 max, (recommend up to 20 decades on one screen to ensure clarity) |
| Input Isolation | 300VAC channel-to-channel, channel-to-ground (Resistance thermometers are not isolated on the eZtrend GR) |
| Noise Rejection (at 50/60Hz) +/-2% | Analogue Input card (std) Common mode: 2Hz = -120dB, 5Hz = -120dB Normal Mode: 2Hz = -80dB, 5Hz = -25dB Analogue Input expansion card (option) Common mode: 2Hz = -120dB, 5Hz = -120dB, 10Hz = -120dB Normal Mode: 2Hz = -85dB, 5Hz = -80dB, 10Hz = -48dB |

| Specification | Logging |
|-----------------------|---|
| Logging Method | Sample, Average, Min/Max - can be set independently per pen |
| Logging Types | Continuous, Fuzzy |
| Logging Rate | DR Graphic/Minitrend GR/Multitrend GR 20 msec. to 60 hours per pen, eZtrend GR 100 msec. to 60 hours per pen, |
| Fuzzy Logging | A secure data storage technique which delivers data compression ratio of 100:1 or more; self teaching, storing the data at a variable rate to match the process |

| Specification | Physical Parameters |
|------------------------|--|
| Enclosure/Bezel | Zinc plated steel case with high impact resistant polycarbonate bezel; scratch resistant lens (Polyethylene Terephthalate). NEMA3 / IP55 for Minitrend GR and eZtrend GR models only and NEMA3R/IP55 for Multitrend GR protection rating standard with NEMA 4X / IP66 (Front face only) protection rating as an option. |

Relay Alarm/Digital Input Specification

| Specification | Physical Parameters |
|---------------------------|--|
| Mounting Panel | <p>Unlimited mounting angle. For the best view of the display the viewing angle should not exceed:</p> <p>Minitrend GR 55° from the left or right, 40° looking down and 50° looking up at the recorder display.</p> <p>Multitrend GR 70° from the left or right, 45° looking down and 55° looking up at the recorder display.</p> <p>eZtrend GR 45° from the left or right, 10° looking down and 30° looking up at the recorder display.</p> <p>Mounting adjustable for panel thickness of 2mm to 20mm. Adapter kits available for covering existing panel cutouts.</p> |
| Dimensions | <p>Minitrend GR/eZtrend GR Recorder - W: 144mm (5.67"), H: 144mm (5.67"), D: 200mm (7.87"). Additional 80mm (3.15") clearance recommended for a straight type power cable and signal connectors. Cutout 138 x 138mm (5.43 x 5.43")</p> <p>Multitrend GR Recorder - W: 288mm (11.34"), H: 288mm (11.34), D: 200mm (7.87"). Additional 80mm (3.15") clearance recommended for a straight type power cable and signal connectors. Cutout 281 x 281mm (11.06 x 11.06")</p> |
| Weight | <p>Minitrend GR Recorder - 2.7 Kg (6lb) max.</p> <p>Multitrend GR Recorder - 10 Kg (22 lb) max.</p> <p>eZtrend GR Recorder - 2.4 Kg (5.3lb) max.</p> |
| Colour | Bezel: Grey std or Black option |
| Wiring Connections | IEC Power Plug. Removable terminal strip for input and alarm connections |

Relay Alarm/Digital Input Specification

Input Range Performance Accuracy Table

Analogue Input standard and expansion cards

| Input Actuation (Linear) | Range | Accuracy | ##Temp. Stability +/- | | Input Impedance | | |
|--------------------------|---|---|--|--------------------------------|--|---------------------------------|-----------------------------------|
| Millivolts DC | -5 to 5, -10 to 10, -25 to 25, -50 to 50, -100 to 100, -250 to 250, -500 to 500, -1000 to 1000 | +/- 0.2% F.S. +/- 0.1% F.S. +/- 0.1% F.S. +/- 0.1% F.S. | 0.01%/ °C 0.01%/ °C 0.01%/ °C 0.01%/ °C | | >10M ohms >10M ohms >10M ohms >10M ohms | | |
| Volts DC | -0.3 to 0.3, -0.6 to 0.6, -1.5 to 1.5, -3 to 3, -6 to 6, -12 to 12, -25 to 25, -50 to 50 | +/- 0.1% F.S. +/- 0.1% F.S. +/- 0.1% F.S. | 0.01%/ °C 0.01%/ °C 0.01%/ °C | | >1M ohms >1M ohms >1M ohms | | |
| Milliamps ** | 4 to 20, 0 to 20 | +/- 0.2% F.S. | 0.01%/ °C | | | | |
| Ohms, 200 | 0 to 200 | +/- 0.1% F.S. | 0.01%/ °C | | | | |
| Ohms, 500 | 0 to 500 | +/- 0.1% F.S. | 0.01%/ °C | | | | |
| Ohms, 1000 | 0 to 1000 | +/- 0.1% F.S. | 0.01%/ °C | | | | |
| Ohms, 4000 | 0 to 4000 | +/- 0.1% F.S. | 0.01%/ °C | | | | |
| Input Actuation (T/Cs) | Range | | Ref. Accuracy | | ##Temp. Stability +/- | #Field Cal Deg° F | #Field Cal Deg °C |
| | °F | °C | +/- °F | +/- °C | | | |
| B* | 500 to 1000 1000 to 3300 | 260 to 538 538 to 1816 | 8.1 4.0 | 4.5 2.2 | 0.01%/ °C | 8.1 2.0 | 4.5 1.11 |
| E* | -454 to -328 -328 to -94 -94 to 1832 | -270 to -200 -200 to -70 -70 to 1000 | 21.6 3.1 1.3 | 12 1.7 0.7 | 0.01%/ °C | 21.6 3.1 0.8 | 12.00 1.7 0.44 |
| J* | -346 to 32 32 to 2192 | -210 to 0 0 to 1200 | 3.1 1.2 | 1.7 0.7 | 0.01%/ °C | 0.8 0.63 | 0.44 0.35 |
| K* | -454 to -94 -94 to 2502 | -270 to -70 -70 to 1372 | 36 1.8 | 20 1 | 0.01%/ °C | 36 0.9 | 20.00 0.5 |
| R* | -58 to 500 500 to 1202 1202 to 3214 | -50 to 260 260 to 650 650 to 1768 | 6.7 2.7 2.0 | 3.7 1.5 1.1 | 0.01%/ °C | 6.7 1.0 1.0 | 3.7 0.56 0.56 |
| S* | -58 to 500 500 to 1832 1832 to 3110 3110 to 3214 | -50 to 260 260 to 1000 1000 to 1710 1710 to 1768 | 5.9 2.7 2.0 2.5 | 3.3 1.5 1.1 1.4 | 0.01%/ °C | 5.9 1.0 1.0 1.0 | 3.3 0.56 0.56 0.56 |
| T* | -454 to -346 -346 to 752 | -270 to -210 -210 to 400 | 9.7 1.8 | 5.4 1 | 0.01%/ °C | 9.7 0.9 | 5.4 0.5 |
| L* | -328 to 32 32 to 1652 | -200 to 0 0 to 900 | 2.2 1.3 | 1.2 0.7 | 0.01%/ °C | 1.0 0.7 | 0.56 0.39 |
| G* (W_W26) | 32 to 212 212 to 600 600 to 1526 1526 to 2759 2759 to 4199 | 0 to 100 100 to 316 316 to 830 830 to 1515 1515 to 2315 | 45 11.2 5.0 3.1 5.0 | 25 6.2 2.8 1.7 2.8 | 0.01%/ °C | 45 11.6 5.0 1.6 5.0 | 25 6.2 2.78 0.89 2.78 |
| C* (W5, W26) | 32 to 356 356 to 2228 2228 to 4199 | 0 to 180 180 to 1220 1220 to 2315 | 4.5 3.6 6.7 | 2.5 2 3.7 | 0.01%/ °C | 4.5 1.8 6.66 | 2.5 1.0 3.7 |
| M* (NiMo-NiCo) (NNM90) | -58 to 698 698 to 2570 | -50 to 370 370 to 1410 | 2.0 1.4 | 1.1 0.8 | 0.01%/ °C | 1.0 0.72 | 0.56 0.4 |
| N* (Nicosil Nisil) | -328 to 212 212 to 2372 | -200 to 100 100 to 1300 | 5.8 2.0 | 3.2 1.1 | 0.01%/ °C | 5.8 1.0 | 3.2 0.56 |
| Chromel/Copel* | -58 to 1112 | -50 to 600 | 1.1 | 0.6 | 0.01%/ °C | 0.54 | 0.3 |
| P* (Platinel) | 32 to 2534 | 0 to 1390 | 2.5 | 1.4 | 0.01%/ °C | 1.4 | 0.78 |
| D* | 32 to 356 356 to 3344 3344 to 4515 | 0 to 180 180 to 1840 1840 to 2490 | 6.3 4 11.7 | 3.5 2.2 6.5 | 0.01%/ °C | 6.3 4 11.7 | 3.5 2.2 6.5 |

Relay Alarm/Digital Input Specification

| Input Actuation | Range | | Accuracy | | ##Temp.Stability+/- |
|---|--------------|-------------|----------|------|---------------------|
| | | | | | |
| PT100 $\alpha = 0.00385$ | -328 to 1562 | -200 to 850 | 1.1 | 0.6 | 0.01%/ °C |
| PT200 $\alpha = 0.00385$ | -328 to 1562 | -200 to 850 | 1.1 | 0.6 | 0.01%/ °C |
| PT500 $\alpha = 0.00385$ | -328 to 1562 | -200 to 850 | 1.1 | 0.6 | 0.01%/ °C |
| PT1000 $\alpha = 0.00385$ | -328 to 1562 | -200 to 850 | 1.1 | 0.6 | 0.01%/ °C |
| 100 ohm Nickel | -76 to 356 | -60 to 180 | 0.9 | 0.5 | 0.01%/ °C |
| 120 ohm Nickel | -112 to 500 | -80 to 260 | 0.5 | 0.3 | 0.01%/ °C |
| Cu10# | -328 to 500 | -200 to 260 | 5.5*** | 3*** | 0.01%/ °C |
| Cu53# | 32 to 302 | 0 to 150 | 0.5 | 0.3 | 0.01%/ °C |

Reference Temperature: 22°C

Reference Sample Rate: 2Hz (500msec)

Reference Humidity: 65% RH +/-15%

Long term stability: 0.2%/year

* Does not include reference junction calibration of ± 1.0 °C using the standard "ice bath" method of calibration. Factory accuracy can be improved by performing a field calibration. Also does not include any error on the sensor.

** Tolerance for these input types includes that of the external shunt resistors (0.1% tolerance)

*** Reference Accuracy can be improved to +/- 0.4°C/0.7°F using the single point compensation calibration.

not available on the **eZtrend GR**, Including all Field Cal values.

Temperature Stability - Interpreted as % of Full Span per deg C change in ambient from Reference condition

| Specification | Options |
|--|--|
| Pulse Input (optional) (not available on the eZtrend GR) | 4 isolated inputs per board, frequency – 1Hz to 25kHz, updated once per sec. Input: Low < 1V, High >4V to <50V or Volt free input: Low = short circuit, High = open circuit. |
| Alarm Outputs (optional) | Programmable alarm set points (6 per pen) can be configured to activate up to 8 outputs for DR Graphic recorders 16 outputs for the Minitrend QX and 48 outputs for the Multitrend GR . Update rate: 200 ms for all alarms. Number/Type: <ul style="list-style-type: none"> • 4 or 8 relay contacts SPDT, 3A 240VAC, 3A 24VAC/DC, 0.2A 240VDC (non-inductive, internally suppressed) • 8 I/O or 16 I/O - SPNO 1A 24VDC (non-inductive, internally suppressed). 16 I/O not available for the eZtrend GR Activation: Fully programmable internal alarm levels. Assignable to any relay or discrete output. |
| Analogue Outputs (Re-transmission Outputs) (optional) (not available for the eZtrend GR) | 2 or 4 re-transmission outputs available for the DR Graphic/Minitrend GR Recorder and 2, 4, 6 or 8 re-transmission outputs available for the Multitrend GR Recorder; a pen drives each output. Analog inputs, totalised values or any mathematical result can be re-transmitted. Update Rate: 250 msec all channels Accuracy: $\pm 0.1\%$ 0-500 Ω load, $\pm 0.25\%$ 500 Ω 1K Ω load Type: 0 to 20 / 4 to 20 mA Maximum Load Resistance: 1000 Ohms Resolution: 0.002% Isolation: 300VAC |
| Digital Input/Output (optional) | 8 I/O or 16 I/O: all channels may be selected freely as either digital inputs or outputs. The Digital I/O card also has 4 channels that can be set as pulse inputs (channels 1 to 4). The operating frequency for pulse inputs on the Digital I/O card is 1kHz max. Input: Low < 1V, High >4.5V to <10V DC (9V to 20V p-p AC) or Volt free input: Low = short circuit, High = open circuit. 16 I/O not available for the eZtrend GR 4 relay outputs: all four channels are relay outputs only. 8 relays/ 2 DI card: two outputs can be configured for use as digital inputs: A digital input is provided by a volt free contact between the normally open (NO) and the common (C) terminals of an output relay. If the 2 Digital inputs are used only 6 relay outputs are available. Closed <500 ohms, Open >300 kohms. |
| Transmitter Power (optional) | DR Graphic/Minitrend GR / eZtrend GR have 200mA @ 24VDC \pm 3VDC. Multitrend GR has 1 Amp @ 24VDC \pm 3VDC.. |
| Agency Approval (optional) | cCSAus, cULus approvals for Multitrend GR / Minitrend GR / and DR Graphic Recorder. cCSAus Approval for eZtrend GR Recorder. Multitrend GR / Minitrend GR /also have FM class 1 Div 2 approval. |

Relay Alarm/Digital Input Specification

| Specification | Options |
|--|---|
| Extended Security System (ESS) (optional) | Provides full support for 21 CFR Part 11. Includes features for entry of unique User ID's and associated passwords, timeout on inactivity (1 to 10 min.), password expiration (1 to 365 days), up to 50 users, password re-entry lock out for incorrect entry of password more than 3 times, no re-use of passwords (programmable 4 to 12 times), traceability by user name |
| Miscellaneous | Optional customer ID Tagging (3 lines of up to 22 characters each line) |
| Firmware Options | |
| Math Algorithms (optional) | All analog input channels have a math expression text block. This is a fully user programmable 100 character free form math expression for each pen. Math calculations available on all pens, one per input plus 16 extra pens for the DR Graphic/Minitrend GR , 48 extra pens for the Multitrend GR recorder. and 12 extra pens for the eZtrend GR . Scripting maths includes conditions and multi-line scripting in pen maths expressions. Allow functions, permanent variables, constants and timers. 500 characters maximum. (Scripting is not available on the eZtrend GR) |
| Events (optional) | Events are certain conditions or operations that can be set up and logged according to the time and date of an occurrence. Subsequently events can be reviewed or displayed on a graph. The Event Causes include: Alarms - Into/Out of and Alarm Ack, Totals - Start/Stop/Reset/Reset and Start, Digital Input - ON/OFF/State Change, T/C Burnout, Scheduled - Once/Interval/Specific Days/Month End, User Counters, Max/Mins - Reset, System - Power ON/Setup Change/Internal Memory Low/Export Memory Low/FTP Memory Low, User Action - Mark Chart, Batch - Start/Stop/Pause, TUS - Start/Stop, AMS2750 - TC Timers/Process Timers, TC Health Monitor - Analogue Inputs. The Event Effects include: Mark Chart, Logging - Start/Stop, Totaliser - Start/Stop/Reset/Reset & Start, Digital Output - ON/OFF, Alarm Acknowledge, Emails, Screen Change, Print Screen, Counters - Reset/Increment, Max/Min (Reset), Chart Control - Pause/Stop/Resume/Clear/Prefil, Clear All Messages, Delayed Event, Script Timers - Start/Stop/Reset/Reset & Start, Play Sound - Start/Stop, Display Alert, Reports, Batch - Start/Stop/Pause, Reports, Update Tabular readings, Enter Replay Screen, Exit Replay Screen, Change Chart Speed. Each event marker can be recorded for analysis using the TrendManager-Software Suite. |
| Fast Scanning mode | For fast processes, the scan rate and recording of the data can be set for up to 50 times per second (20ms) for up to 8 inputs for the DR Graphic/Minitrend GR and 8 inputs for the Multitrend GR . |
| Totaliser/Sterilisation* (optional) | One totaliser per pen. Totaliser value must be assigned to a pen for display and storage. Multiple totalisations (Maths option) are possible with the use of extra pens (option). Reset may be manual or programmed (Event option). Totalisation values are ten digits plus exponent. Each pen can be totalised according to the Fo or Po sterilisation* function at 250 °F (121.11°C). The Standard Reference Temperature and Thermal Resistance (Z Value) are fully adjustable values of X, Y, W and V. Start temp, Reference temp and Z factor are all user defined, allowing support for many different types of sterilisation applications. |
| Custom Screens (optional) (not available for the eZtrend GR) | Provides the capability in the recorder to accept custom screen designs from the Screen Designer. |
| Reports | Generate reports manually or using the event system to show daily/weekly/monthly Totals, Max/Mins, Averages, Current Value. Messages, Message Lists - Alarm, System, Diagnostic, Security & User, Counters, Digital Inputs, and Digital Outputs. Reports can be printed, e-mailed as an attachment or exported to external media in RTF format. |
| AMS2750 Process | AMS2750 Process activates the Process Mode screen and the AMS2750 process configuration menus for furnaces and sensors in accordance with AMS2750D specification, including Thermocouple tracking. |
| Health Watch/Maintenance Capability (optional) | The recorder keeps track of important "life actions" for improved diagnostics and preventative maintenance notification. Including Powered On, Last powered On, Time On since power up, Total On time, Total Off time, Longest Off time, Lithium cell life, Backlight life left at 100% brightness, Hi/Lo CJC value (Hi & Lo temps), Analogue In last factory/user cal, Relay operations, last configuration change. |
| Print Support (optional) | Enables the printer option to print from various Status screens using a basic USB standard PCL (Printer Command Language) printer. |
| AMS2750 TUS | AMS2750 TUS activates the TUS screen and the AMS2750 TUS configuration menus for furnaces and sensors in accordance with AMS2750D specification, including Thermocouple tracking. All of the survey information can be exported to a Report Generating tool. |

Relay Alarm/Digital Input Specification

| Specification | Options |
|--|--|
| Batch/Groups | The Batch function allows the user to segment portions of data for further analysis. The Batch function manages sections of data. Concurrent batches are now associated with a group of pens. The pens within each group will belong to the batch that is controlled by that group. Maximum 32 pens per group. Batches can be controlled through the event system and batch markers are setup by the user and used to identify and analyse batches of data. Supports up to 6 concurrent batches. |
| Counters | User Counters can be set up and used as a part of the Events system to count an occurrence. Other counters are available depending on hardware availability. Eg. Alarm, Event, Digital Input, Relay Output and Pulse counters. |
| Modbus Master | Modbus master enables the recorder to communicate with up to 32 Slave devices on both Ethernet & RS485. The recorder itself can also act as a slave device while also being a master. |
| Remote Viewer/Remote Control Tool | Extends the user interface of the recorder onto the desktop PC. Providing full remote control of the recorder launched from a web browser. |
| Email (optional) | Setup email accounts to send the following: When an Alarm is triggered or an Email can be sent as a part of an Event occurring, such as: Alarms - In/Out/Ack, Totaliser – Start, Stop or Reset, Digital Inputs – On, Off or State change, TC Burnout – on a specific Analogue Input channel, Scheduled Events – Once, Interval, Specific days, Month End. |
| Pwd Net Sync (optional) | Password Network Synchronisation. Password can be synchronised over the network, a recorder can be designated as a master of a password group and other recorders can be added to that group as slaves, the master will ensure all passwords are synchronised with all recorders in its group. up to 32 recorders can be in a Password group, this include the password Master. |
| Secure WSD | WSD is a web service that can run on devices and conforms to the Devices Profile for Web Services (DPWS). |
| Extra Pens (4 pens) (optional) | 4 extra pens to store and display totalised values, results of calculations, etc. Maximum is up to 16 extra pens for the DR Graphic/Minitrend GR , 12 extra pens for the eZtrend GR recorders, and 48 extra pens for the Multitrend GR recorder. |
| Hardware Lock | Uses the password permission areas to lock access to the hardware configuration functionality leaving some areas view only. |

*Specification table for Sterilisation: The definition of Fo/Po is the sterilisation/pasteurisation time in minutes required to destroy a stated number of organisms with a known z at temperature T. For example, "F18/250" represents the time in minutes required to destroy a stated number of organisms at a temperature of 250°F (121.11°C) with a z = 18 degrees F. F values are used to compare the sterilizing values of different processes, however, F values cannot be compared unless the z values are the same. When temperature is not specified (for example, F = 8.6) it is understood that the temperature is 250°F (121.11°C); the subscript O (as in the term Fo = 7.4) is used to indicate that the z = 18 degrees F and the temperature is 250°F (121.11°C).

| Specification | Environmental and Operating Conditions | | | |
|--|--|----------------------------------|----------------------------------|------------------------------------|
| Parameter | Reference | Rated | Extreme | Transport & Storage |
| Ambient Temperature | 67 °F to 77 °F 19 °C to 25 °C | 32 °F to 122 °F 0 °C to 50 °C | 32 °F to 122 °F 0 °C to 50 °C | 14 °F to 140 °F -10 °C to 60 °C |
| Relative Humidity (%RH) | 50 to 65* | 10 to 90* | 5 to 90* | 5 to 95* |
| Vibration | | | | |
| Frequency (Hz) | 0 | 0 to 70 | 0 to 100 | 0 to 100 |
| Acceleration (g) | 0 | 0.1 | 0.2 | 0.5 |
| Mechanical Shock | | | | |
| Acceleration (g) | 0 | 1 | 5 | 20 |
| Duration (ms) | 0 | 30 | 30 | 30 |
| Mounting Position from Vertical | | | | |
| Tilted Forward | 5° | 40° | 40° | Any |
| Tilted Backward | 5° | 65° | 65° | Any |
| Tilted to Side (+/-) | 5° | 65° | 65° | Any |

Relay Alarm/Digital Input Specification

| Specification | Environmental and Operating Conditions | | | |
|------------------------------|--|---|---|-----|
| Power Requirements | | | | |
| Mains Voltage (Vrms) | 120 to 240 | 100 to 240 | 90 to 264 | N/A |
| Low Voltage AC (Vrms) | 18 +/- 2 | 12 to 20 Minitrend GR & eZtrend GR 20 to 30 Multitrend GR & DR Graphic | 12 to 20 Minitrend GR & eZtrend GR 20 to 30 Multitrend GR & DR Graphic | N/A |
| DC Voltages | 24 +/- 2 | 20 to 55 DR Graphic/Multitrend GR 12 to 30V Minitrend GR/ & eZtrend GR | 20 to 55 DR Graphic/Multitrend GR 12 to 30V Minitrend GR & eZtrend GR | N/A |
| Frequency (Hz) | 49.8 to 50.2 | 47 to 63 | 47 to 63 | |
| Power Consumption | Minitrend GR/eZtrend GR: AC: <40W (max), DC: <40W (max) Typical 20W. Multitrend GR: AC/DC : < 60 W (max) ; Typical : 30W DR Graphic: AC: <50 VA (max), DC: <40W (max) Typical 25W | | | |
| Warm Up | 30 minutes minimum | | | |
| Seismic Qualification | Complies with IEEE 323-1974 and/or 1983 and IEEE 344-1975 and/or 1987 (option). Hardware includes an IEC bracket (except DR Graphic). | | | |

* The maximum rating only applies up to 104°F (40°C). For higher temperatures, the RH spec is de-rated to maintain constant moisture content

LED Flash Codes

LEDs are fitted on the Analogue Input card, Analogue Output card, Pulse Input card, 4 and 8 Alarm Relay cards and the 8 and 16 Digital IO cards. The LEDs can be seen through six holes on the left side of the **Minitrend GR / eZtrend GR** recorders, and 18 holes on the **Multitrend GR** recorder (looking from the front).

For **DR Graphic** recorders the LEDs are not directly visible. They can be seen on the left side of the IO cards chassis if the unit is ON & IO card chassis is rested on the bottom stand.

Table 12.3 :

| Red LED Flash codes: | Sequence: | Type of Fault: |
|-------------------------|--|----------------|
| 1,1 | flash once, pause, flash once, pause etc. | Hardware |
| 2,2 | flash twice, pause, flash twice, pause etc. | Communications |
| 3,3 | flash three times, pause, flash three times, pause etc. | Memory |
| 4,4 | flash four times, pause, flash four times, pause etc. | Other |
| 1,2 | flash once, pause, flash twice more quickly, pause, flash once etc. (added as CJC could be unplugged...) | CJC fault |
| 1,3 | If another error is also present with CJC error, flash once, pause, flash 3 times | CJC fault + |

Red LED flash codes relate to the first fault stored in the error buffer. With no faults, the red LED remains off.

When the red LED is flashing, the green LED stays lit. The green LED flashes for normal operation. The board outputs the flash code for about 30 seconds after it was registered.

Relay Alarm/Digital Input Specification

Appendix A: Quality and Safety

CE Mark

Honeywell GR Series recorders are compliant with Low Voltage Directive 2006/95/EC as amended by 93/68/EEC, and the Electromagnetic Capability Directive 2004/108/EC as amended by 92/31/EEC and 93/68/EEC.

Safety

The product range of instruments is compliant with the requirements of BS EN 61010-1:2010 "Safety Requirements for Electrical Equipment for Measurement, Control and laboratory Use" and UL 61010-1 (3rd Edition) and CSA 22.2 No.61010-1:2012. If the equipment is used in a manner not specified, the protection provided by the equipment may be impaired.



Appendix B: Maths Expressions

Full Maths & Script Processing

The **GR Series** recorders are supplied with Basic Maths functions: Add, Subtract, Divide and Multiply. There are two further options that can be added, Full Maths and an extremely powerful Scripting processing module. Scripting delivers an additional level of enhanced capabilities with multi line script processing. Full and Scripting Maths must be activated in the recorder as a Firmware credit option. (Scripting is not available on the **eZtrend GR**).

When a recorder setup is loaded into the **TrendManager** software the Maths capabilities will be transferred with the setup. If you are creating a new recorder in **TrendManager** software to be transferred to a recorder the Maths capabilities will be available but will only become active if the recorder has the same Maths functions enabled.

This document provides the Maths Variable and Function table and examples of the capabilities from the simple to the complex to assist the user in understanding the concepts and potential of these features.

*** Important Note, Full Maths and Script functions are Options and must be enable using the Credit System. Be sure to enable these options or they will not be available. [See “Firmware Credit System” on page 241.](#)

Notes:

- if, elseif & else are followed by expressions in “curly brackets” {...}
- lines within the curly brackets always end in semicolon e.g. ;
- every execution path must have a return statement. As soon as a return is executed the script finishes; make sure that the return is the last operation to be executed.
- every expression within curly brackets “{...}” does not have to include a “return”
- Small values (fractions) entered into a maths expression will require a zero before the decimal point. Eg. 0.5. Decimal point and not comma must be used always.
- Outputs that are set to Single Pulse should not be used as a part of a maths expression as it can cause spurious values.
- No white spaces
- Syntax is not case sensitive
- 500 character limit for scripting

NOTICE

Full Maths and Scripting functions are Options and must be enabled using the Credit System. Be sure to enable these options in the recorder or they will not be available. [See “Firmware Credit System” on page 241.](#)

Maths Credit Options

Full Maths firmware credit option will allow the functions listed in [Table 14.1 on page 322](#) and [Table 14.2 on page 324](#).

Scripting firmware credit option will allow the Full math functions plus the scripting functions in [Table 14.3 on page 326](#), [Table 14.4 on page 327](#), [Table 14.5 on page 328](#), [Table 14.6 on page 328](#) and [Table 14.7 on page 329](#).

Maths Variable and Function Tables

Table 14.1 : Maths Variable Table

| Maths Variables | Syntax | Description |
|---|------------------|---|
| Alarm Level | PnAxL | Gets the Alarm Level, n is Pen number 1 to 96 and x is alarm number 1 to 6 |
| Analogue Input (Eng values) | An | Get the value of Analogue n (1 to 48) in Engineering units |
| Analogue Raw (Electrical values) | RAn | Get the value of Raw Analogue n (1 to 48) in Electrical values |
| Batch Mode | BATMD1 to BATMD6 | Per group. Returns 1= batch running, 2 = batch stopped or 3 = batch paused |
| Batch comment list | blcomm[x] | Get index of Batch comment list entered on batch start, where X is the group number (1 - 6) |
| Batch description list | bldesc[x] | Get index of Batch description list entered on batch start, where X is the group number (1 - 6) |
| Batch lot number list | bllot[x] | Get index of Batch lot No list entered on batch start, where X is the group number (1 - 6) |
| Batch name list | Blname[x] | Get the index of Batch name list entered at batch start. Where x is the group (1-6) |
| Batch user list | Bluser[x] | Get the index of Batch user list entered at batch start. Where x is the group (1-6) |
| Blkv | BLKVx | Get the local variable x. This variable is local to this script. There is a maximum of 20 local variables per script. |
| SD card free storage space* | CFFREE | Returns the percentage of free storage space available on the SD card |
| CJC | CJcN | Get the Board CJC value. N = 1 to 6 (Returns value in Degrees F, C or K depending on the localisation setting) |
| CJC in Degrees C | CJcNc | Get the Board CJC value. N = 1 to 6 (Always returns value in degrees C) |
| Comms Variables** | CVn | Get the Comms variable n = 1 to 96 |
| Digitals | Dn | Get the value of Digital Input or Digital output n (1 to 48) |
| Digital Input bit pattern | DIO n | Get the 16 bit pattern from the DIO slots, where n= 1,2 or 3 (Slot G, H & I respectively). Returned as a 16 bit word (0 to 65535). A channel configured as an output is set to 0. |
| EC1 to EC 20 | EC1 | Event Counters 1 to 20 |
| File Transfer Protocol recording hours left | FTP HRS | Returns the number of hours of "safe" recording time available |
| Glbv | GLBVx | Get the global variable x. This is a global variable accessible to all scripts. There is a maximum of 200 global variables. |

Table 14.1 : Maths Variable Table

| Maths Variables | Syntax | Description |
|----------------------------|--------------|--|
| HPC1 to HPC48 | HPC1 | High Pulse count using Pulse cards |
| Internal memory hours left | INTHRS | Returns the amount of hours left until the internal memory starts to recycle (over-write). |
| IOC1 to IOC48 | IOC1 | Digital Input/Output counters for Digital in and relay out |
| LPC1 to LPC48 | LPC1 | Low Pulse count using Digital IO cards in pulse count mode |
| Pen | Pn | Get the value of Pen n (1 to 96) |
| Pen Minimum Value | PnMINU | Gets the Pen Minimum value n = 1 to 96 |
| Pen Maximum Value | PnMAXU | Gets the Pen Maximum value n = 1 to 96 |
| Pen report Maximum Value | prmax[x,y,z] | Gets the Pen Maximum value for a report. x = pen number (1 to 96). y = period (1 = hour, 2 = day, 3 = week, 4 = month). z = report set (1 = current, 2 = previous completed) |
| Pen report Minimum Value | prmin[x,y,z] | Gets the Pen Minimum value for a report. x = pen number (1 to 96). y = period (1 = hour, 2 = day, 3 = week, 4 = month). z = report set (1 = current, 2 = previous completed) |
| Pen report Average Value | prave[x,y,z] | Gets the Pen Average value for a report. x = pen number (1 to 96). y = period (1 = hour, 2 = day, 3 = week, 4 = month). z = report set (1 = current, 2 = previous completed) |
| Pen report Totaliser Value | prtot[x,y,z] | Gets the Pen Totaliser value for a report. x = pen number (1 to 96). y = period (1 = hour, 2 = day, 3 = week, 4 = month). z = report set (1 = current, 2 = previous completed) |
| Power Relay | PWRREL | Returns the status of the fixed power relay |
| Pstv | PSTVx | Get the persisted Global variable x. Persisted global variables maintain their value through a power cycle. There is a maximum of 50 persisted global variables. |
| PRC | PRC | Power Relay Counter |
| Pulse Inputs (AI slots) | HPULn | Get the Pulse frequency from the Pulse card n = 1 to 48 (25kHz max) |
| Pulse Inputs (DIO Slots) | LPULn | Get the Pulse frequency from the Digital Input card when in Pulse mode n = 1 to 48 (1kHz Max) |
| RT Compensation | RTCOMPn | Get RT Compensation value for channel n (1 to 48) Units mV |
| RT Calibration | RTCALn | Get RT Calibration value for channel n (1 to 48). Units mA |
| Slave Comms Variable*** | SCV[1,1,1] | Returns the value for the Modbus Slave Comms |
| Totaliser | Tn | Get Totaliser value n = 1 to 96 |

Table 14.1 : Maths Variable Table

| Maths Variables | Syntax | Description |
|-------------------------|----------|---|
| UC1 to UC16 | UC1 | User counters 1 to 16 |
| USB1 free storage space | USB1FREE | Returns the percentage of free storage space available on the USB storage key fitted initially (front or rear). |
| USB2 free storage space | USB2FREE | Returns the percentage of free storage space available on the USB storage key fitted after the first USB has been fitted (front or rear). |
| UV1 to UV32 | UV1 | This allows a system to be setup where values can be altered to effect calculations without having to change the configuration |

*SD Card is available on the **eZtrend GR** as a credit option.

** See [Figure 22.1, "Comms variables," on page 361.](#)

*** Slave Comms Variable.

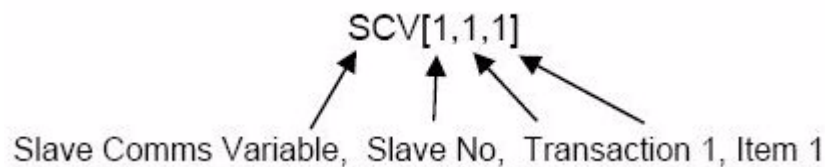

Table 14.2 : Maths Function Table

| Maths Functions | Syntax | Description |
|-----------------|-------------|--|
| Add | + | Returns the result of the addition |
| ACos* | acos[x] | Returns the Arc COS of x |
| ASin* | asin[x] | Returns the Arc SIN of x |
| ATan* | atan[x] | Returns the Arc TAN of x |
| Ceiling | ceil[x] | Round up x to the nearest whole number |
| Clear Event** | CLRE[x] | Where x is the event number to be cleared (1 to 20). |
| Cos* | cos[x] | Returns the COSINE of x |
| CosH* | cosh[x] | Returns the Hyperbolic COSINE of x |
| Damp | damp[x,y,z] | x = input, y = Pen (pen variable being used) and z = damping limit in engineering units. See "Damping examples:" on page 326. |
| Divide | / | Returns the result of the division |
| Eval | eval[x] | Returns 1 if x is non zero, otherwise returns zero |
| Exponent | exp[x] | Returns the Exponential of x |

Full Maths & Script Processing

Table 14.2 : Maths Function Table

| Maths Functions | Syntax | Description |
|----------------------------|------------|---|
| Floating Point Absolute | fabs[x] | Returns the Floating Point Absolute value of x |
| Floor | floor[x] | Round down x to the nearest whole number |
| Get Screen Number | GETS[x] | returns the current screen number, where x in the screen number. this can be used to detect what screen is being displayed |
| Global Alarm Status | ATOTt[x] | ATOT[0] will return the total number of alarms that are currently enabled in the recorder. ATOT[1] will return the total number of alarms "in Alarm" state in the recorder. E.g P1= ATOT[1]/ATOT[0] * 100 would set P1 to give alarm state percentage for the recorder. |
| Ln | ln[x] | Returns the Natural Log of x |
| Log | log[x] | Returns the Base 10 Log of x |
| Modulus | x%y | Returns the value of x with a modulus of y |
| Multiply | * | Returns the result of the multiplication |
| Pen Edit "Maths" | vmemavail | Scale: 0 to 1048576 K |
| Pen Edit "Maths" | memavail | Scale: 0 to 1048576 K |
| Power | pow[x,y] | Returns the value of x raised to the power y. Can also be represented by ^ |
| Power | x^y | Returns the value of x raised to the power y. |
| Reciprocal | recip[x] | Returns the reciprocal of x (i.e. 1/x) |
| Root | root[x,y] | Returns the y root of x |
| Round | round[x] | Rounds x to the nearest whole number |
| Serial Comms Variable | SCV[x,y,z] | Returns serial variables during Modbus comms. X = Slave number, y = Transaction number, z = Item number |
| Set/clear a digital output | SETD[x,y] | This feature allows a digital output to be set or cleared from a script, using the function SETD[x,y] where x is the digital output 1 to 49 (where 49 is the power relay) and y is the value 1 to set or 0 to clear. The function will return the value set if successful, if not successful it will return -1.0, this would be caused by trying to set and digital input rather than output. |
| Set User variable | UVSET[x,y] | Returns the result of x = the user variable and y = the value. |
| Sin* | sin[x] | Returns the SIN of x |
| SinH* | sinh[x] | Returns the Hyperbolic SIN of x |
| Square Root | sqrt[x] | Returns the Square Root of x |
| Square | sq[x] | Returns the square of x (i.e. x multiply by x) |
| Subtract | - | Returns the result of the subtraction |

Table 14.2 : Maths Function Table

| Maths Functions | Syntax | Description |
|--------------------|----------|---|
| Tan* | tan[x] | Returns the TANGENT of x |
| TanH* | tanh[x] | Returns the Hyperbolic TANGENT of x |
| Trigger an Event** | TRIGE[x] | This will trigger Event x (1 to 20). TRIGE[x] will return 1 when the event is fired otherwise it will return 0. |

*** Functions use radians (2π radians = 360 degrees)**

**** Event triggering from scripts**

This feature allows any enabled event with an enabled effect (does not have to have any causes enabled) to be triggered from within the scripting system using the following function, TRIGE[x] where x is the event 1 to 20. Once an event is triggered using scripting the event is locked and cannot be triggered again from scripts until the lock is cleared using the clear event function CLRE[x] where x is the event number 1 to 20. This prevent successive executions re-triggering the same event. As a further measure to avoid the system being overloaded by events from within the script system, each time an event is triggered from within a script it will apply a 1 second automatic lock preventing the same event from being triggered more then once a second, irrespective of the CLRE[x] being called for that event.

Damping examples:

Example 1: if P1 was measuring degrees C the expression $P1 = \text{damp}[A1, P1, 3]$ will damp the signal with changes up to 3 degrees C, any change over 3 degrees between readings will be damped but by a small amount.

Example 2: $P5 = \text{damp}[A2, P5, A3]$ will damp the A2 input up to a level determined by input A3, note the reference parameter (P5) is always the same as the pen it is being used in, this should always be the case.

Table 14.3 :

| Compare & Convert | Syntax | Description |
|-------------------|----------------|--|
| %RHc | rhc[x,y] | Returns % Relative Humidity with y as the dry bulb temperature in degrees C, and x the wet bulb temperature in degrees C |
| %RHf | rhf[x,y] | Returns % Relative Humidity with y as the dry bulb temperature in degrees F, and x the wet bulb temperature in degrees F |
| C2f | c2f[x] | Converts a temperature in °C to one in °F |
| F2c | f2c[x] | Converts a temperature in °F to one in °C |
| Hi | hi[x,y] | Returns the larger value of x & y |
| Hi4 | hi4[x,y,x1,y1] | Returns the larger value of x, y, x1,y1 |
| Inside | inside[x,y,z] | Returns x if between y & z, otherwise returns 0. |
| Lo | lo[x,y] | Returns the lower value of x & y |
| Lo4 | lo4[x,y,x1,y1] | Returns the lower value of x, y, x1, y1 |

Table 14.3 :

| Compare & Convert | Syntax | Description |
|-------------------|----------------|--|
| Outside | outside[x,y,z] | Returns x if outside of y & z, otherwise returns 0 |
| Over | over[x,y] | Returns x if it's larger than y, otherwise returns 0 |
| Under | under[x,y] | Returns x if it's less than y, otherwise returns 0. |

Table 14.4 : Script Timers

| Timers | Syntax | Description |
|--------|-----------|--|
| Tget | tget[x] | Returns the elapsed time of timer x since start |
| Tpause | tpause[x] | Pauses the timer x |
| Treset | trset[x] | Resets the timer x |
| Trun | trun[x,y] | Starts the timer x in y mode. (Mode 1 = reset to 0 and run, Mode 0 = resume from previous value) |

Timers must return a value. All timer commands must have "BLKV1 = the variable" e.g. BLKV1 = tpause[1]. Value returned is the same as tget[1]. Timers count in seconds. Maximum of 20 timers available.

Table 14.5 :

| Accessors | Syntax | Description |
|-----------|--------------|--|
| Ai | Ai[x] | Get the value of Analogue Input number x |
| Alamct | Almct[x,y] | Get the current alarm count for Pen x, Alarm y (the alarm number as identified in alarm messages) |
| Alamrt | Almrt[x,y] | Get the current alarm number for Pen x, Alarm y |
| Alamsl | Almsl[x,y,z] | Get the current alarm level set . Pen = x (1-96), Alarm = y (1-6), New level to set = z. Eg. P3 = almsl[1,1,A3] will set Pen 1 alarm1 and show A3 pen P3. |
| Alamst | Almst[x,y] | Get the current alarm state for Pen x, Alarm y (1 = active 0 = inactive) |
| Di | Di[x] | Get the state of Digital input number x |
| Glbv | Glbv[x] | Get the value of global variable number x |
| Locv | Locv[x] | Get the value of local variable number x |
| Pen | Pen[x] | Get the value of Pen number x |
| Tot | TOT[x] | Get the current value of totaliser x |

Table 14.6 :

| Boolean Operators | Syntax | Description |
|--------------------------|--------|--|
| AND | && | Returns a true or false result from testing if two tests are both true. e.g. IF (A1==GLBV1) && (A2!=GLBV2) |
| Assign | = | Assigns one variable to another. e.g. GLBV1=A1. (GLBV1 becomes the value of A1). |
| Equal to | == | Returns a true or false result from testing if two variables are equal to each other. e.g. IF (A1==GLBV1) |
| Greater than | > | Returns a true or false result from testing if one variable is greater than another |
| Greater than or equal to | >= | Returns a true or false result from testing if one variable is greater or equal to than another |
| Less than | < | Returns a true or false result from testing if one variable is less than another |
| Less than and equal to | <= | Returns a true or false result from testing if one variable is less than or equal to another |
| NOT | ! | Returns true if the result is 0, otherwise returns false. |

Table 14.6 :

| Boolean Operators | Syntax | Description |
|-------------------|--------|--|
| Not equal to | != | Returns a true or false result from testing if two variables are not equal to each other. e.g. IF (A1!=GLBV1) |
| OR | | Returns a true or false result from testing if one or other or both tests are true. e.g. IF (A1==GLBV1) (A2!=GLBV2) |
| XOR | ~ | Returns a true or false result from testing if one or other (but not both) tests are true. e.g. IF (A1==GLBV1) ~ (A2!=GLBV2) |

Functions for Scripts

(Scripting is not available on the **eZtrend GR**).

Scripts evaluate at whatever the Analogue sample rate is set to.

There is 500 character limit for scripting

Table 14.7 :

| Functions for Scripts | Syntax | Description |
|-----------------------|----------------|--|
| Else | else | Steps into brackets to run. Must always finish with a return. else { return y; } |
| Elseif | elseif(x) | Carries out a conditional test and if true steps into brackets to run. Must always finish with a return. elseif (x>4) { return y; } |
| First run | (FIRSTRUN) | Returns true if the script is being run for the first time, otherwise returns false |
| If | if(x) | Carries out a conditional test and if true steps into brackets to run. If false, steps to next test without operating the contents of the brackets. Next step will be either <i>elseif</i> or <i>else</i> . Must always finish with a return. If (x>5) { return y; } |
| Set Changed | (SETUPCHANGED) | Returns true if the setup has been changed, otherwise returns false |
| Time Changed | (TIMECHANGED) | Returns true if the time has been changed, otherwise returns false |

Full Maths

Full Maths functions provides a simple and intuitive method for the user to carry out numerous mathematical functions. Some examples are shown below

Table 14.8 : Full Maths examples

| Full Maths examples | |
|---------------------|---|
| P4=lo[A1,A2] | Pen 4 shows the result of the lowest of either A1 or A2 |
| P3=(A1+A2)*SQRT[A3] | Pen 3 shows the result of Analogue input 1 added to Analogue input 2, all multiplied by the square root of Analogue input 3 |
| P4=GLBV1 | P4 shows the Global Variable 1 |

NOTICE

Please note **“Pn=”** is **not entered in the Maths Block** and is assumed by the Recorder e.g. To enter the equation $P2=A2$, the user would just type A2

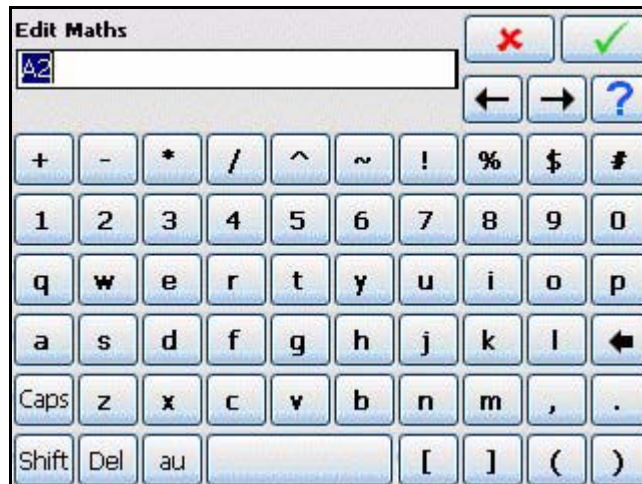

Script Function Application Examples

(Scripting is not available on the **eZtrend GR**).

To enter a script for a Pen, ensure that “Maths Type” in the Pen Menu is set to Scripting.

Example 1

4 flow meters are fed into the recorder to trend, totalise and record daily flow. The application requires that the user must know and record which flow meter is outputting the highest flow at any particular time. This can of course be derived from the four lots of recorded data, but not only is this extra analysis later, but a real time display is required.

The application is easily solved by using the Script Function in the recorder, represented in pseudo code the script is as follows:

If input 1 is bigger than all the others, then make the global variable (1) equal to channel 1, and display and record input 1.

If input 2 is bigger than all the others, then make the global variable (1) equal to channel 2, and display and record input 2.

If input 3 is bigger than all the others, then make the global variable (1) equal to channel 3, and display and record input 3.

If none of the above are correct then Input 4 must be the highest, so make the global variable (1) equal to channel 4, and display and record input 4.

Display the global variable (1) on another pen to show which channel is biggest at any given time.

Pen 5 is chosen to record the highest channel input, and channel 6 is chosen to record which input is the highest.

The greater than “>” is used, the AND “&&” Boolean is also used, and the global variable GLBV1 is used to hold the current highest channel number.

Converting this to an actual script gives the following:

| | |
|------------------------------------|--|
| If ((A1>A2)&&(A1>A3)&&(A1>A4)) | This tests if flow meter 1 is more than 2, 3 and 4 |
| { | |
| GLBV1=1; | If yes, then set display indicator to meter 1 |
| return A1; | And return the current flow reading |
| } | |
| elseif ((A2>A1)&&(A2>A3)&&(A2>A4)) | This tests if flow meter 2 is more than 1, 3 and 4 |
| { | |
| GLBV1=2; | If yes, then set display indicator to meter 2 |
| return A2; | And return the current flow reading |
| } | |
| elseif ((A3>A1)&&(A3>A2)&&(A3>A4)) | This tests if flow meter 3 is more than 1, 2 and 4 |
| { | |

| | |
|------------|--|
| GLBV1=3; | If yes, then set display indicator to meter 3 |
| return A3; | And return the current flow reading |
| } | |
| else | If none of the above are true, then 4 is biggest |
| { | |
| GLBV1=4; | So set display indicator to meter 4 |
| return A4; | And return the current flow reading |
| } | |

In this application, the flow meters are connected to inputs 1, 2, 3 and 4 at the rear of the recorder, and these are recorded on Pens 1 to 4

P1=A1

P2=A2

P3=A3

P4=A4

Pen 5 has the script above, which records and displays the highest flow rate of the four.

Pen 6 is set to record and display the input (between 1 and 4) that is the highest rate

P6=GLBV1

NOTICE

Please note “**Pn=**” is not entered in the Maths Block and is assumed by the Recorder e.g. To enter the equation P2=A2, the user would just type A2

Example 2

In the same application as above, the user has noticed that whilst flow meter 2 normally has the highest flow rate, on occasion a surge in flow meter 3 causes problems. The user needs to monitor the two inputs and count the number of times flow meter 3 reading exceeds that of flow meter 2.

The code consists of the two flow meter readings, and a change counter that totals the number of times that flow 3 exceeds that of flow 2.

The pseudo code is written as:

If flow meter 3 has a larger reading than flow meter 2, check to ensure that it was already greater than meter 2, if it was return the latest change count value.

If it was not greater than meter 3 last time, set a flag to indicate a change and increment the change counter by 1, then return the latest change counter.

If flow meter 3 is less than 2, simply return the change count value with no increment.

Pen 7 is used to implement this script and is implemented as follows

Full Maths & Script Processing

| | |
|----------------|--|
| if (A3>A2) | Tests if A3 is bigger than A2 |
| { | |
| if(BLKV1==1) | If it was then tests if A3 was bigger than A2 last time period |
| { | |
| return BLKV2; | If it was return with the current change counter |
| } | |
| else | If not then |
| { | |
| BLKV1=1; | Set flag to show that A3 has just exceeded A2 |
| BLKV2=BLKV2+1; | Increment the change counter by 1 |
| Return BLKV2; | Return the new change counter total |
| } | |
| else | If A3 is not bigger than A2 |
| { | |
| BLKV1=0; | Set flag to show A2 is bigger than A3 this time |
| Return BLKV2; | Return current change counter |
| } | |

With script above, BLKV (all Variables) are used to maintain values. It should be noted that BLKV's do not persist over a power removal, and if the application were to require a non-volatile count, then BLKVn should be substituted with PSTVn.

Example 3

The application described in Examples 2 and 3 is to be extended to totalise the amount of time that Input 1 is the highest of 1, 2, 3 & 4.

Again scripting can be used to easily solve this requirement.

The Pseudo code is written as

If input 1 is indicated as the current highest value, then display the timer.

If input 1 is not the highest input value, then stop totalising time and return the current timer value.

We know that in Example 1, the highest value channel number is contained with GLBV1, and as this is a global variable it is also accessible from this script.

| | |
|------------------|--|
| if (GLBV1==1) | Tests if the global variable 1 is equal to channel 1 |
| { | |
| BLKV1=trun[1,0]; | If it is then keep the timer running without resetting |
| return tget[1]; | Return the current timer value |
| } | |
| else | If not then |
| { | |
| BLKV1=tpause[1]; | Pause the timer |
| return tget[1]; | Return the current (paused) timer value |
| } | |

Note in this script above there is no way to reset the timer, this could be modified to allow the user to reset this timer from a switch fed into a digital input as follows:

| | |
|------------------|--|
| if(D1!=1) | Tests if the DI 1 is not set |
| { | If it isn't then |
| if (GLBV1==1) | Tests if the global variable 1 is equal to channel 1 |
| { | |
| BLKV1=trun[1,0]; | If it is then keep the timer running without resetting |
| return tget[1]; | Return the current timer value |
| } | |
| else | |
| { | If not then |
| BLKV1=tpause[1]; | |
| return tget[1]; | Pause the timer |

Full Maths & Script Processing

| | |
|------------------|---|
| } | Return the current (paused) timer value |
| } | |
| else | If it is |
| { | |
| BLKV1=treset[1]; | reset the timer 1 to zero |
| return tget[1]; | return the current (zeroed) timer value |
| } | |

Example 4

Commenting in Scripts

This is an example of how commenting can be used in scripts. you can use the standard C++ commenting, inline comments use \\

for example

```
if ( A1 > 10 )
{
    return 9;    // If A1 greater then 10 return 9
}
```

or for block (single or multiline commenting the /* to open and */ to close, these are C style comments and work as follows

```
if ( A1 > 10 )
{
    return 9;    /* If A1 greater then 10 return 9 */
}
```

for single line or

```
if( A1 > 10 )
{
    /* if A1 is greater then 10 then return 9
    */
    return 9;
}
```

these are also useful for commenting out code to try different things, for example

```
if( A1 > 10 )
{
    return 9;
}
/*
else
{
    return 20;
}
*/
return A1;
```

Here the else statement is "commented out" so it won't be included but can easily be re-introduced if required.

Maths Error Messages

When the Maths functionality is processing through the scrips you have written it will carry out Syntax and other checks. When it comes across operations, functions, brackets, etc. not expected or permitted it will report an error. However, the fault being reported may be on a previous line caused by the missing or incorrect function. Refer to Application Note 43-TV-07-32 on your CD or web site for a list of scripting error messages.

Appendix C: Thermocouple Connections

How Thermocouples work

Thermocouples produce a voltage dependant upon the temperature gradient between the hot and cold junctions. The hot junction is the measuring junction of the thermocouple, the cold junction is the point where the thermocouple wires are connected, usually the connection block on the back of the recorder.

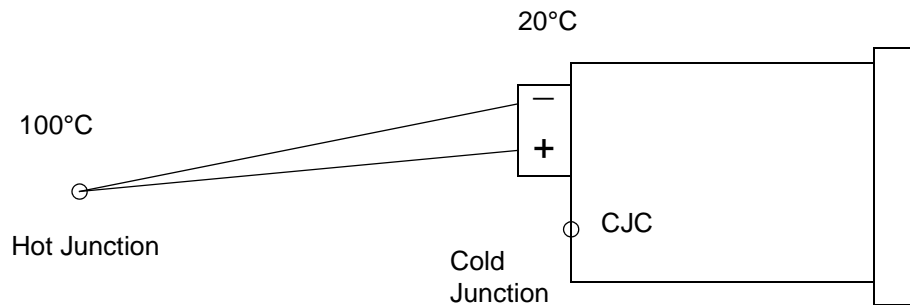

If the hot (measuring) junction is at 100°C and the connection block of the recorder is at 20°C the thermocouple will produce a voltage corresponding to 80°C, the difference between the hot and cold junctions.

For the recorder to correctly report the 100°C it needs to know the temperature at the cold junction. There are 4 options of cold junction compensation (CJC) on the recorder that are detailed below. The simplest and most common is to use the "Internal Automatic" compensation. This uses a CJC sensor built onto the AI board to measure the connector temperature. In this case it will measure 20°C, this will then be added to the 80°C measured by the thermocouple to give a displayed reading of 100°C.

The 4 methods of cold junction compensation are described below.

All diagrams show passive burnout, for active burnout replace the + for *.

Thermocouple CJC Compensation

The different methods for connecting thermocouples according to the type of reference are shown below.

Internal Automatic

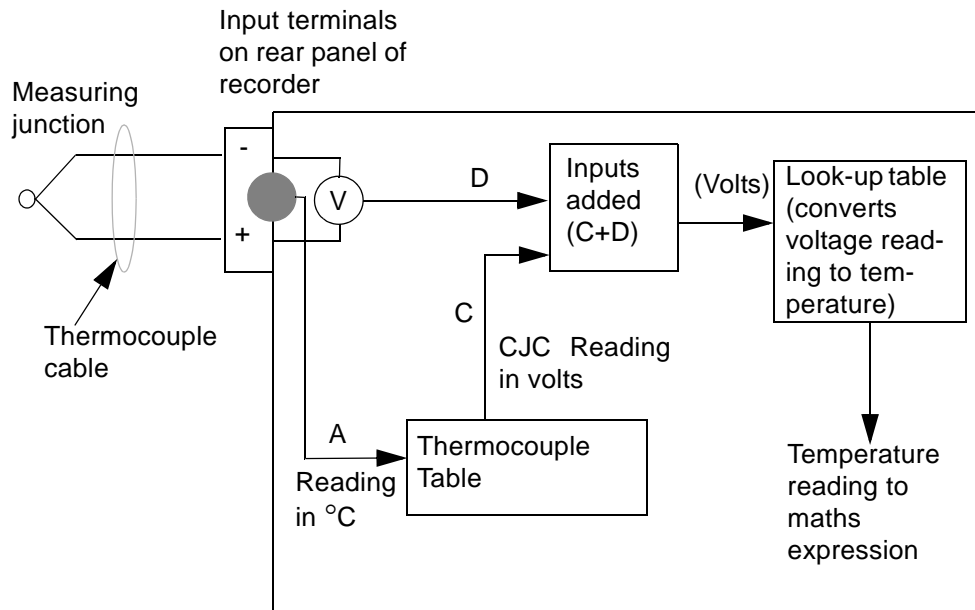

Internal Auto. This is connected to the input terminals of the recorder, and the temperature at this junction is being measured by a temperature sensor on the rear panel of the recorder. The reading from this sensor is read off against a value taken from the thermocouple table, which corresponds to the type of thermocouple being used. The corresponding reading in volts for the temperature measured by the sensor is then used as a reference for the reading from the thermocouple.

Diagram shows passive burnout, for active burnout replace the + for *.

Thermocouple CJC Compensation

Ext 0°C Reference

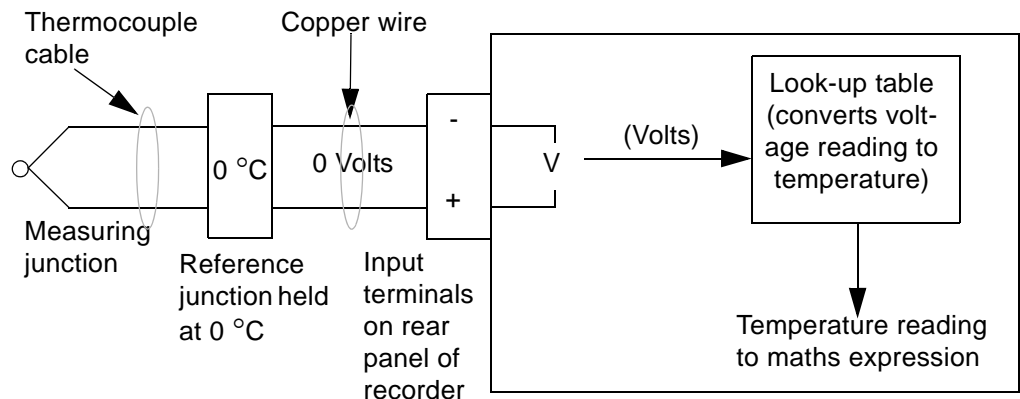

Ext 0°C Reference. By keeping the reference junction at 0 °C then the negative input is acting as a 0 Volt reference so the voltage reading from the thermocouple can be passed directly to the tables where the corresponding temperature reading can be found.

Diagram shows passive burnout, for active burnout replace the + for *.

External with a Specified Temperature

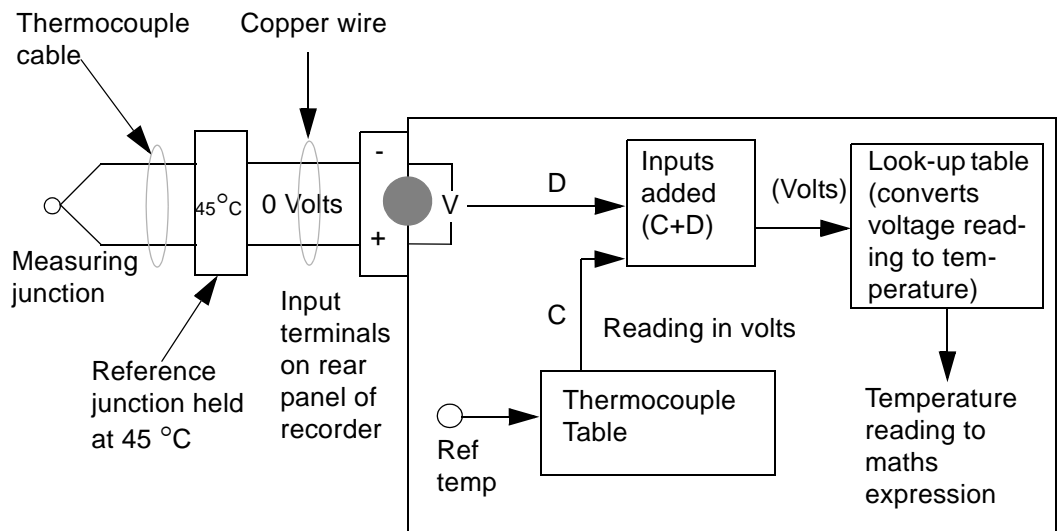

External Reference with a specified temperature. The reference junction is kept at a constant known temperature other than 0°C. This temperature can be specified in the setup menus. This reference temperature is then used in the same way as the reading from the temperature sensor using the **Internal Reference** method.

Diagram shows passive burnout, for active burnout replace the + for *.

External Input Reference

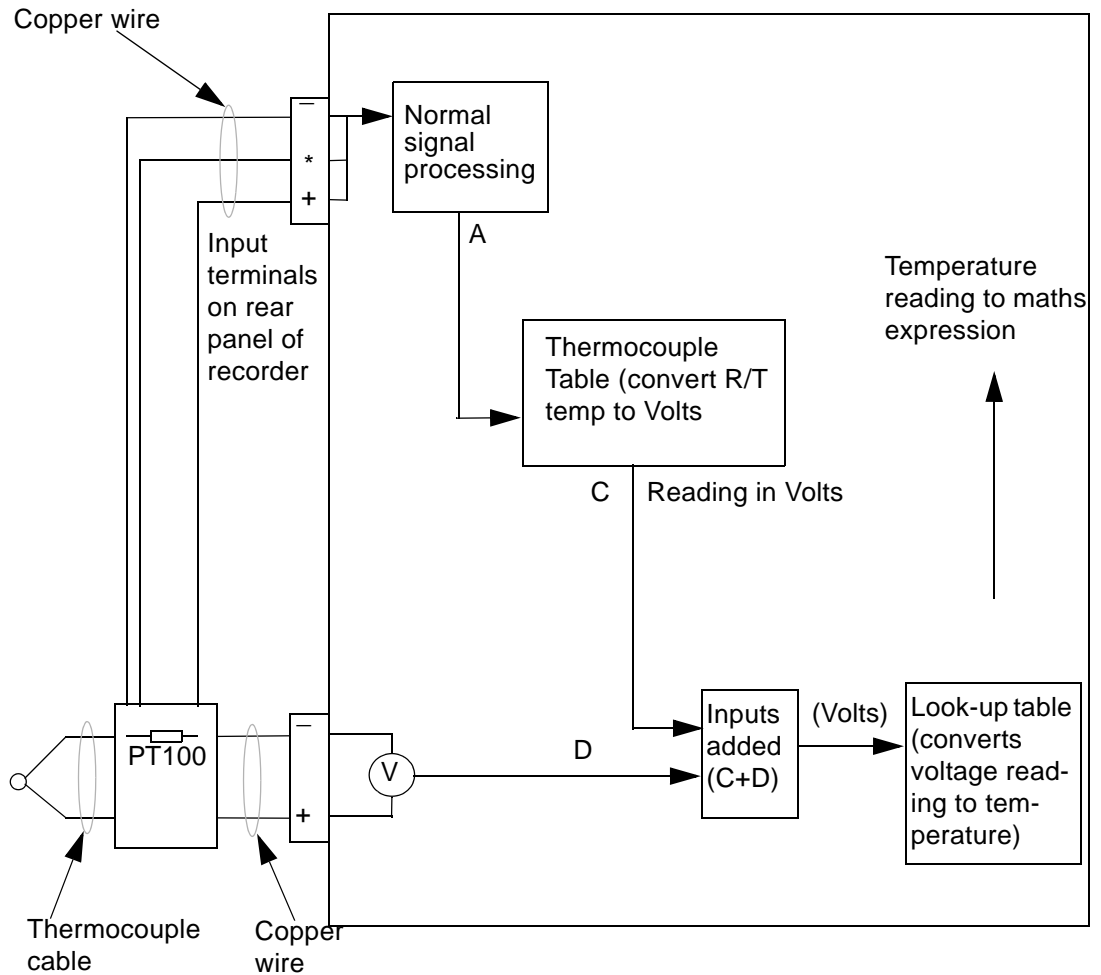

External Input Reference. The reference temperature reading in this method is provided by a separate temperature measuring device connected to another input, usually RT. This input is processed in the normal way and then passed back into the thermocouple signal processing system as a temperature reading.

Appendix D: Alarms

Alarms Menu

(Main Menu > Alarms >)

Acknowledge, Configure and View alarms from this menu.

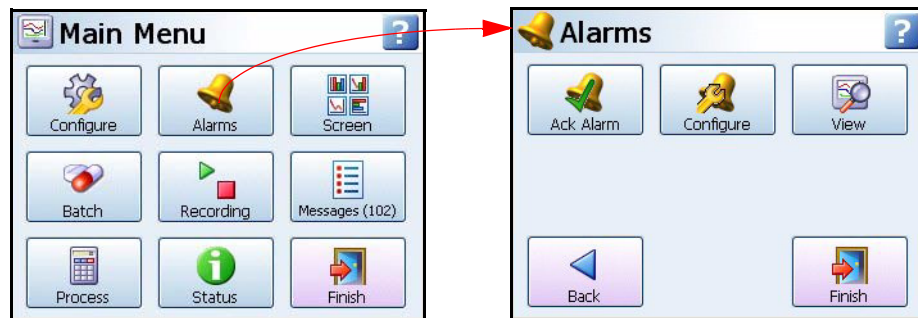

Acknowledging Alarms

User acknowledgment of alarms can be performed at this menu, only latched alarms can be acknowledged.

If a latched alarm is set up in the Pen, Alarms menu then a latched relay will maintain in its active state until the trigger source has returned to a no alarmed state and the alarm has been acknowledged.

A latched alarm will continue to flash, if an alarm marker is displayed, until it is acknowledged and in a non-alarm state. See [“Alarm Markers” on page 236](#) for flash colour identification.

Ack Alarm

- **All** - Select this button to acknowledge all active alarms, latched and normal alarms.
- **By Group** - Select this button to acknowledge any alarms in a group of pens. Pen groups can be set up in the Pens menu
- **By Pen** - Select this option to acknowledge any alarms for individual pens.

Configure

This will display all available Pens with alarms set up.

To change the configuration, select the desired pen, this will display the alarm details.

Select the Edit button to change the alarm level.

If the Edit button is greyed-out go to the [“Alarms Menu” on page 88](#) menu and select the alarm, then activate Allow Change.

View

This will display all available Pens with alarms set up. To view the configuration, select the desired pen, this will display the alarm details.

When complete go to Finish to commit the new set up.



Ethernet

Ethernet is a local area network (LAN) technology that transmits information between computers and other devices, at speeds of 10 or 100 million bits per second (Mbps). Each Ethernet equipped device operates independently of all other devices on the network.

All devices attached to an Ethernet network are connected to a shared signalling system. Ethernet signals are transmitted serially, one bit at a time, over the shared signal channel attached to each device.

It is up to the high-level protocol that is sending data over the network to make sure that the data is correctly received at the destination device.

Devices attached to an Ethernet network can send application data to one another using high-level protocol software, such as TCP/IP protocol suite.

High-level protocols have their own system addresses, such as the 32-bit addresses used in the current version of IP. The high-level IP-based networking software in a device is aware of its own 32-bit IP address and can read the 48-bit Ethernet address of its own network interface, but it doesn't know the Ethernet addresses of the other devices on the network.

To discover the Ethernet addresses of other IP-based devices on the network another high-level protocol is used. For TCP/IP, this is done using a protocol called Address Resolution Protocol (ARP).

Example:

Device X has an IP address of 195.23.37.1 and sends data over the Ethernet channel to another IP-based device, Device Y with IP address 195.23.37.2. Device X sends the packets of information containing an ARP request. The ARP request is asking the device with the IP address of 195.23.37.2 to identify the address of the Ethernet Interface.

Only Device Y with the IP address of 195.23.37.2 will respond, sending a packet with the Ethernet address of device Y back to device X. Now device X and Y have each others Ethernet addresses to which data can be sent.

Email

General operation of the e-mail system

The recorder sends messages for distribution by an e-mail server. The e-mail server is located by its IP address or it's name as set-up in the communications set-up options. When the recorder sends an e-mail message, it locates the e-mail server and uses SMTP (Simple Message Transfer Protocol) to send the message to the e-mail server. SMTP allows the recorder to send messages to an e-mail server without having its own e-mail address; because of this the e-mail server will not be able to send any reply back to the recorder.

When setting-up the e-mail address list, it is important to include the e-mail administrator address. The Administrator e-mail address is the e-mail address to where the e-mail server will respond in the event of any problems with the delivery of e-mail messages. The Administrator will also appear to be the source of any e-mail messages sent by the recorder. Most e-mail systems require a 'Reply To' address as part of an e-mail message, since the recorder does not have its own e-mail address; it uses the e-mail administrator as the 'Reply To' address.

Any e-mail message will consist of a delivery list (recipients), a subject, and an optional message body. The message body may be omitted for very short messages, or where the message is to be sent to a paging system.

The e-mail subject may be either one of the existing event markers, or one of the two e-mail subjects. The e-mail message body may be either one of the existing event markers, or one of the two e-mail message blocks. Event markers are restricted to 80 characters each. The two e-mail message blocks are restricted to just over 1000 characters each. Both the message subject and body may contain embedded marker tags as used in the event markers.

When the recorder sends an e-mail message that includes a message body, the recorder name, recorder number and the time/date will be appended to the end of the message body text. This is to allow easy identification of when the message was send, and by which recorder.

Any e-mail message is sent as an action within the recorder events system, so anything that can be configured to act as an event cause, may be configured to send an e-mail message. Any e-mail message may be sent to up-to 12 of the recipients. If the e-mail server supports named groups of e-mail addresses, an e-mail message may be sent to a combination of e-mail addresses and e-mail group.

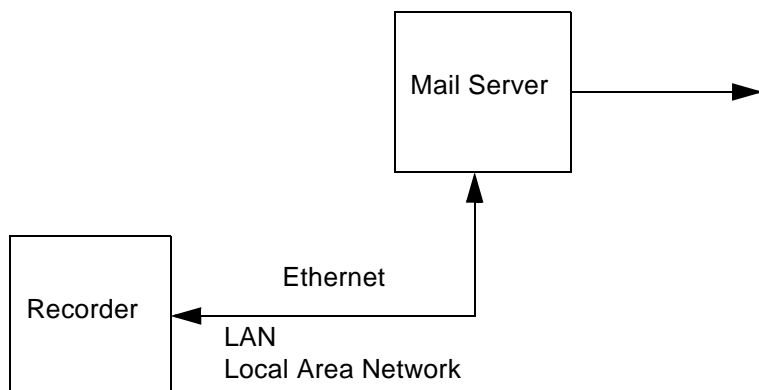

Appendix F: Fuzzy Logging

What is Fuzzy Logging?

Fuzzy Logging is a real time Data Compression technique. *Patent no. US 6,405,155 B2*, developed at **Honeywell** as an alternative to the more standard methods of recording data.

Paperless Recorders are primarily used for exception recording. They spend most of their life trending and recording straight lines. Fuzzy Logging has been developed to improve the efficiency of data storage, and is particularly effective in exception recording examples where normal operation consists of generally static inputs.

Fuzzy Logging looks for straight lines in the data stream, in real time, whether they are horizontal, climbing or descending. A straight line made up of say 10 points can be equally well represented by 2 points, one at either end, the other 8 points are redundant. Fuzzy logging works by creating straight lines in the data and discarding redundant points.

What's it for?

..... To help the user in the trade off between **Scan Rate**, **Disk capacity** and **Recording Time**, after all the 'Pie' is only so big.

Fuzzy Logging has been developed to help maximise all three sections, in effect increasing the size of the 'Pie'.

The result is a technique that delivers a host of real world benefits over the more traditional recording methods.

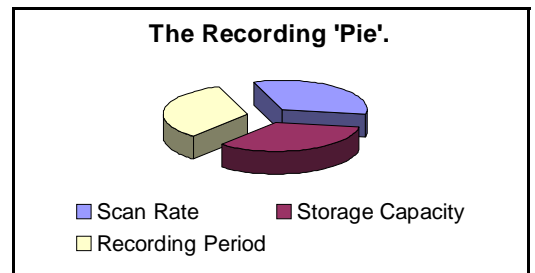

1. Disks take longer to fill – changed less frequently, less site visits.
2. Faster scan rates can be used for any given disk size – giving greater resolution on the process.
3. Recording time can be extended.
4. Less hard disk memory required for archiving on the PC.
5. Quicker graphing of data.
6. Smaller data files for remote collection.

How does it work?

Fuzzy Logging does not log data points that form part of a straight line.

The technique is best illustrated by the diagram below:

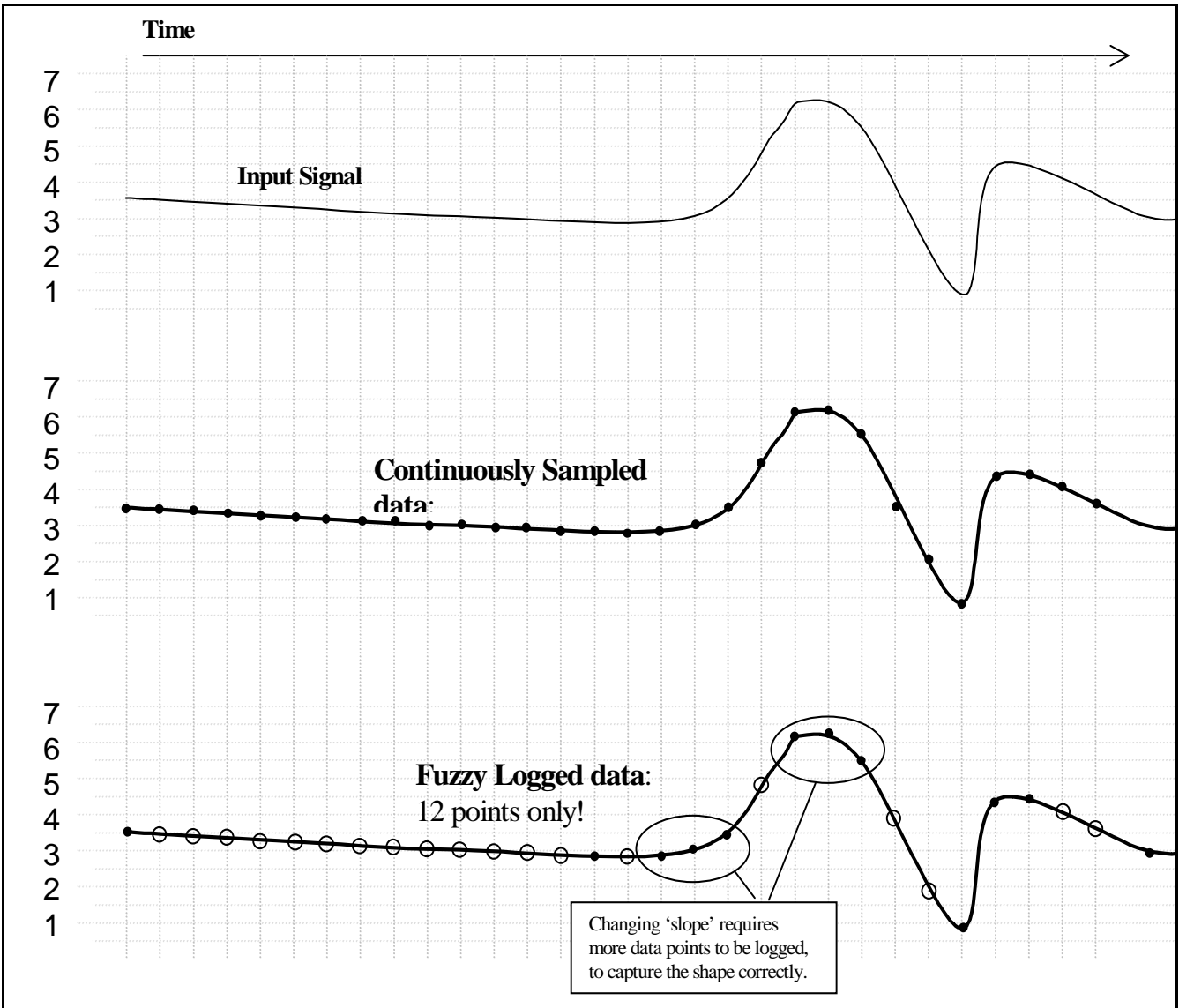

Diagram 1

Points marked: ○ are **NOT** logged, as they lie on an 'imaginary' straight line between points marked:

The graph of the Fuzzy Logged data, looks identical to the graph of the sampled data, but has taken **less than half the points** to build it.

What about 'Spikes' on my trend line? Won't it miss them?

NO, you will not miss any 'Spikes', 'Glitches' or 'Transients' – these are what you need to see!

As Fuzzy Logging is an adaptive technique, it will log as fast as it needs to in order to capture everything.

Although not all points are logged, the base 'Scan Rate' of the input is the same as if you were using a standard logging technique.

What about slowly drifting inputs?

Again – **No Problem**. The algorithm is processed in ‘Real Time’, i.e. as the reading is taken. As it already knows the previous logged readings it can calculate where the next point should be (assuming it’s on a straight line) – if the measured value does not equal the predicted value, the point is logged as it no longer forms part of the straight line.

Fuzzy Logging, looks for straight lines – **at any angle**. Not just on the horizontal.

Do you have any examples?

Example 1.) Flow & Pressure Measurement of Mains Water Pressure

A recorder was installed, to monitor the flow of a mains water supply. At peak demand the mains pressure had been subject to sharp drops in pressure and flow rate, and it was necessary to find the cause of the problem.

The recorder had to have a fast scan rate, in order to capture the ‘glitches’.

The recording period would be over many days if not weeks, so storage capacity was at a premium.

A fast scan rate using the standard sampling method would result in a disk life of about a day, which was not acceptable.

As this application consists of long periods of little activity (relatively constant flow rate), and short periods of high activity (rapidly changing flow rate), it is ideally suited to Fuzzy Logging.

During the hours of stable flow where the flow rate remained more or less constant, the Fuzzy Logging technique would give compression ratios up to 100 times. However, as soon as a glitch appeared the fast sampling rate was able to capture and store all the points.

Example 2.) Cold Storage Temperature Measurement

A recorder was required to help track random and rapid temperature changes within the cold storage rooms. Conventional sample recording had shown that temperature variations were present, but was not of high enough resolution to pinpoint the cause.

Again as in example 1), the measured inputs would show long periods of stable constant readings, interspersed with small sharp increases in temperature. In order to track the cause of these variations, it was necessary to maximise the time resolution of the data. This application was ideally suited to the Fuzzy Logging data storage technique, as the periods of inactivity would result in compression rates of over 50 times.

Example 3.) Logged Data Example

The diagram below is a sample of actual logged data in both the Fuzzy Logging method (top) and Sample Logging method (bottom), derived from the same analogue input.

It provides an excellent illustration of how less data points can be used to construct an identical trace.

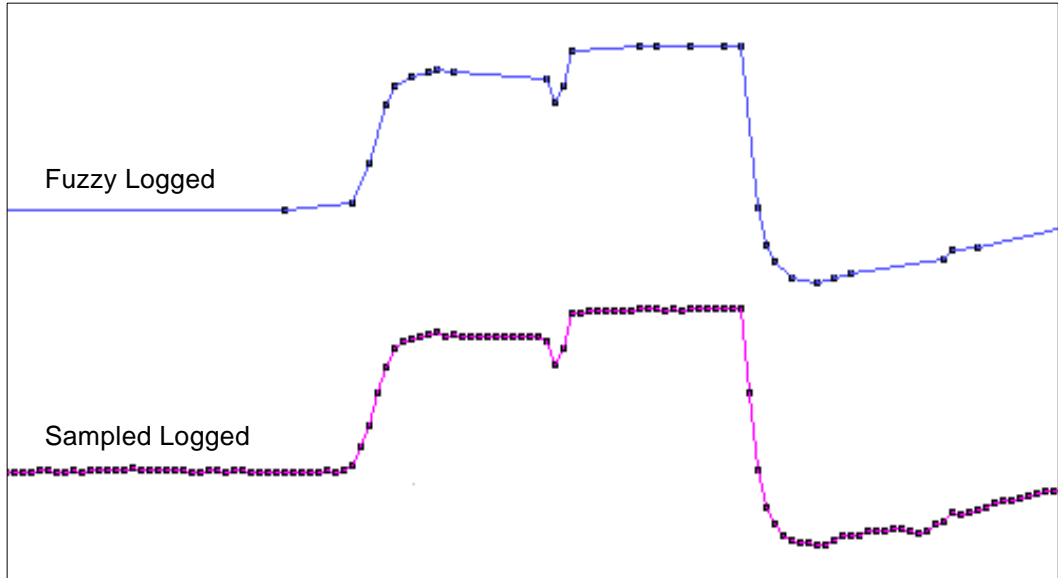

Diagram 2.

Note. This data extract was taken from a 56 hour temperature run, which resulted in approximately 1 Mbyte of sample data, and approximately 40 Kbyte of Fuzzy Logged data.

A compression ratio of 25 times!!

Anything else it can do?

Yes! Fuzzy Logging can be used as a **'One Hit'** recording button.

In applications where the measured process is new or the ideal scan rate is unknown Fuzzy Logging is ideal, as it adapts the log rate to the input signal, and can therefore find the optimum logging rate for you.

Tolerance band widths

Tolerance band width can be set as a percentage of the scale range allowed above and below the input signal.

A second band width can be set, this is where a tighter tolerance can be specified which must be set within the limits of Band 1. Specify, as a percentage of the scale range, the tolerance band allowed above and below the input signal. [See "Logging Menu" on page 86..](#)

Figure 18.1 Fuzzy logging tolerance settings

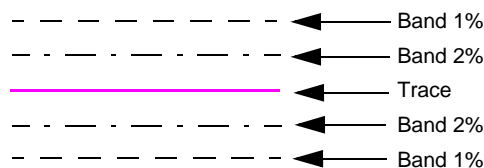

Appendix G: F sub zero Sterilisation

The significance of F_0

The F_0 value is used in the pharmaceutical and related industries in the sterilisation of items. A brief summary is included here to give the essence of the meaning of the terms used.

When items are subjected to sterilisation by heating, the rate at which micro-organisms are killed is dependent on the temperature.

Traditionally items were sterilised by holding them at 250 °F (= 121.11 °C), and the F_0 value for a sterilisation is simply the equivalent time at this temperature that would produce the same effect. For many "average" micro-organisms each minute at 121.11 °C reduces the number present by a factor of 10, so a 15-minute hold at this temperature would reduce the number by a factor of 10^{15} .

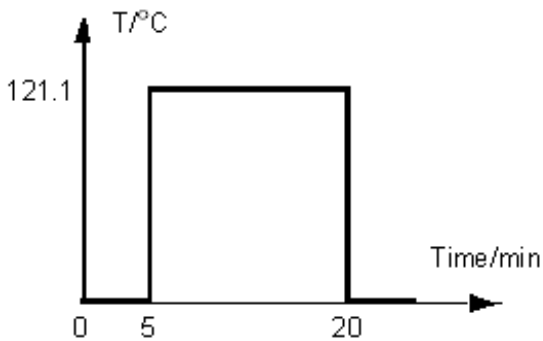

Figure 1

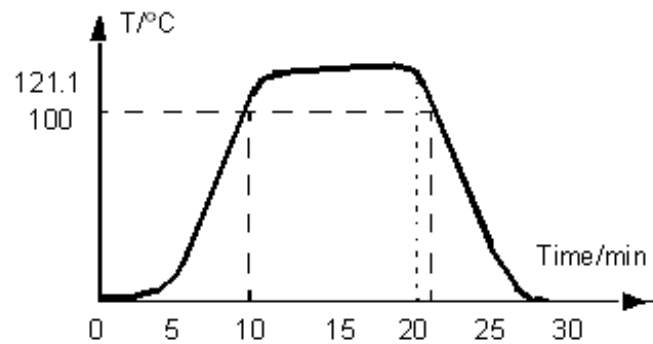

Figure 2

If it were possible to heat a sample from ambient to 121.11 °C in 1 second, hold it there for 15 minutes, and then cool it back to ambient in 1 second, the temperature / time profile would look something like the trace in [Figure 1 on page 349](#) and the F_0 value would be 15, representing 15 minutes at 121.11 °C.

In practice, of course, to reach this temperature the object would have to be subject to an initial heating period up to that temperature, and later a cooling period back down again to ambient temperature, more like the profile shown in [Figure 2 on page 349](#). During all this heating up, holding at temperature, and subsequent cooling, micro-organisms are being killed at different rates, and the F_0 value is calculated by summing the effect at each temperature (provided it is over some defined starting temperature - see below).

This calculation is performed by using the expression, where T is the temperature in °C and Δt is the time spent at that temperature. The z factor that appears in this equation is the temperature coefficient for the destruction of micro-organisms, and is the increase in temperature, in °C, that produces a 10-fold increase in sterilisation rate.

This summation is only performed once the sample temperature has reached some specified starting temperature. For example in [Figure 2 on page 349](#) if this starting temperature has been set to 100 °C (a common value) then the F_0 summation would begin at $t = 8$ minutes when the temperature first reaches this value.

Because of this small, but increasing contribution to F_0 once T reaches 100 °C, and the fact that in this trace the temperature exceeds 121.11°C, the F_0 value reaches 15 at time $t = 20$ minutes, at which point the sterilisation is complete, and cooling begins.

For some applications it is allowed to report the F_0 value that is finally achieved as the sample cools back to the start temperature, in this example 100 °C, and so the contribution under the curve up to $t = 22$ minutes would be included in the reported F_0 . The final F_0 value might then be 16.1, say, with 15 having been achieved up to $t = 20$ minutes, and the extra 1.1 having accumulated during the cooling back to 100 °C between $t = 20$ minutes and $t = 22$ minutes.

The terms used in setting up the F_0 totaliser, together with their default values, are summarised in this table.

| Term | Definition | Default values | Allowed Range |
|------------------------------|--|----------------|---------------|
| F_0 | The equivalent time in minutes at 121.11°C that would produce the same degree of sterilisation. This is the totaliser output value | | |
| z factor | The temperature increase in °C above the reference temperature that will produce a 10-fold increase in the rate of sterilisation | 10 | 5 - 20 |
| Start temperature | The temperature in °C above which the contributions to F_0 can be counted | 100 | 90 - 120 |
| Reference Temperature | The reference temperature for sterilisation, normally 121.11°C, can be altered if required. | 121.11°C | |
| Include cooling phase | If TRUE, contributions to F_0 can be included after the target value has been reached and while the temperature is still above the start temperature. If FALSE, these contributions are not included | FALSE | - |
| Completion Value | The maximum F_0 totaliser value can be set if "Include cooling phase" is not selected, the totaliser will stop at this value of F_0 . | 15 | 1 - 999 |

For setting up the F_0 calculation refer to the ["Totaliser Menu" on page 90](#).

Appendix H: Calibration

AI Calibration and CJC Calibration

For AI and CJC Factory and User Calibration see [“Calibration” on page 132](#)

Sensor Compensation

Sensor Compensation may be required to improve accuracy on a sub range. This is an adjustment to the value of the signal input on each channel, based on the Engineering units.

To set this up in the recorder see Sensor Comp in the menu for [“Analogue In Menu” on page 73](#) or for AMS2750 (Process and TUS modes) see [“Sensors Configuration Menu \(Process Mode\)” on page 386](#).

Choose from Single Point, Dual Point and Multi Point Cal.

Single Point

Set the **Comp Type** to **Single Point** to adjust the signal input reading by an offset amount determined by the user. Enter the **Offset** adjustment required and this is added or subtracted for all future readings.

Dual Point

Select **Dual Point** to change two points on the signal input reading. The Dual Point adjustment works in the same way but at two different points on the signal input. It is recommended that the two points should be more than 50%, of the engineering units, away from each other.

Low Eng and **High Eng** are the two points where the adjustment offset is made. The user can enter their own adjustment points on the signal input and enter the **Offset** for both points.

Main Menu > Configure > Setup > Edit > Field IO > Analog In > Sensor Comp

Figure 20.1 Dual Point Compensation

| | |
|-------------|------------|
| Comp Type | Dual Point |
| Low Eng | 0.0 |
| Low offset | 5.0 |
| High Eng | 100.0 |
| High offset | -5.0 |

Navigation: Back, Copy To, Finish, ?

Sensor Compensation

- **Compensation Type** - select from None, Single Point or Dual Point compensation.
- **Low Eng** - (only available when Dual point is selected). Set the Low limit for the Engineering units.
- **Low Offset** - enter an offset value that is offset against the Low Eng value.
- **High Eng** - (only available when Dual point is selected). Set the High limit for the Engineering units.
- **High Offset** - enter an offset value that is offset against the High Eng value.

Figure App H.21 Sensor Compensation

Solid line shows without compensation and dotted line shows with compensation

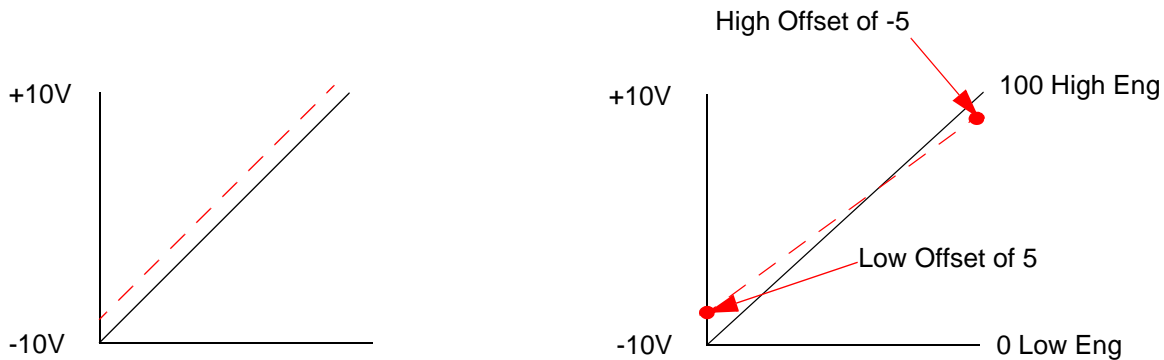

Single Point Sensor Compensation is used to offset the signal input by a user specified amount over the full range.

Dual Point Sensor Compensation is used to offset the signal input by a user specified amount against the Low and High Eng values. The offset amount can vary throughout the signal input range.

Multi Point

The Sensor comp. screen for a multi point cal. will show the user compensation type (Multi Point) and the number of values in the table.

To configure the multi point cal table, select the "value" button and the instrument will display a table entry screen. This table is a minimum of 2 (default) points and a maximum of 9 points.

Additional rows can be added or deleted by using the Add button or select a channel to insert or delete channels above or below the row selected. The input temperature is entered in the left column and the respective offset to be applied, entered in the right column. Once the table is complete, the settings are accepted by clicking the tick button.

All configuration changes are not fully saved until the "Finish" and "Commit" actions have been completed.

Appendix I: Battery Data

Location: Processor Board

Located on the processor board this battery is used mainly for Clock battery back-up.

| | |
|---------|--------------------------------|
| Type | 6032 |
| IEC | CR2032 |
| System | Li/MnO ₂ /org.elyt. |
| Voltage | 3.0 V |

| Cell Type | Typical Capacity (mAh) | Weight |
|-----------|------------------------|--------|
| 6032 | 230 mAh | 3 gms |

| | | Approx Percentage (%) of total weight |
|--------------------------|---|---------------------------------------|
| Active Materials | Manganese dioxide (MnO ₂) | 29 |
| | Propylene carbonate (PC) | 4.3 |
| | 1,2 Dimethoxyethane (DME) | 2.1 |
| | Lithium metal (Li) | 2 |
| | Carbon (C) | 0.9 |
| | Lithium perchlorate (LiClO ₄) | 0.3 |
| Passive Materials | Stainless steel | 57.6 |
| | Plastic | 3.8 |

Safety Guidelines

- Keep batteries out of the reach of children, especially those batteries fitting within the limits of the truncated cylinder as defined in ISO/DP 8124/2.2.
- In the case of ingestion of a cell or battery the person involved should seek medical assistance promptly.
- It is of extreme importance that batteries are inserted into equipment correctly with regard to polarity (+ and -).
- Do not attempt to revive used batteries by heating, charging or other means.
- Do not dispose of batteries in fire.
- Do not dismantle batteries.
- Do not short circuit batteries.
- Batteries should be disposed of in accordance with local regulations, they must not be disposed of with normal refuse.



Appendix J: Function Codes and Memory Maps

Modbus Memory Map Supplement:

Refer to document Modbus® Serial Communications User manual, 51-52-25-66 Rev.S.

NOTE: Some Modbus masters may require an offset of 1 for example instead of entering 1800 enter 1801. First 10 addresses and end address shown in all tables for reference.

Analogue Input value (48 inputs max.)

| Address Hex | Address Decimal | Description | See Appendix 51-52-25-66 |
|-------------|-----------------|----------------------------|--------------------------|
| 1800 | 6145 | Analog In 1(Start Address) | A.6 |
| 1802 | 6147 | Analog In 2 | A.6 |
| 1804 | 6149 | Analog In 3 | A.6 |
| 1806 | 6151 | Analog In 4 | A.6 |
| 1808 | 6153 | Analog In 5 | A.6 |
| 180A | 6155 | Analog In 6 | A.6 |
| 180C | 6157 | Analog In 7 | A.6 |
| 180E | 6159 | Analog In 8 | A.6 |
| 1810 | 6161 | Analog In 9 | A.6 |
| 1812 | 6163 | Analog In 10 | A.6 |
| 185E | 6239 | Analog In 48 (end address) | A.6 |

Relay Output/Digital Input (48 inputs max.)

Allows you to read digital inputs and set relay outputs over Modbus

| Address Hex | Address Decimal | Description | |
|-------------|-----------------|--|--|
| 1-9 | 1-9 | Relay Out/Digital In 1-9 (1 = start Address) | |
| A-F | 10-15 | Relay Out/Digital In 10-15 | |
| 10-19 | 16-25 | Relay Out/Digital In 16-25 | |
| 1A-1F | 26-31 | Relay Out/Digital In 26-31 | |
| 20-29 | 32-41 | Relay Out/Digital In 32-41 | |
| 2A-2F | 42-47 | Relay Out/Digital In 42-47 | |
| 30 | 48 | Relay Out/Digital In 48 (48 = end address) | |

Modbus Memory Map Supplement:

*Communications Inputs (32 comms values max.)**

| Address Hex | Address Decimal | Description | See Appendix 51-52-25-66 |
|-------------|-----------------|-------------------------|--------------------------|
| 1880 | 6273 | Comms 1 (start address) | A.7 |
| 1882 | 6275 | Comms 2 | A.7 |
| 1884 | 6277 | Comms 3 | A.7 |
| 1886 | 6279 | Comms 4 | A.7 |
| 1888 | 6281 | Comms 5 | A.7 |
| 188A | 6283 | Comms 6 | A.7 |
| 188C | 6285 | Comms 7 | A.7 |
| 188E | 6287 | Comms 8 | A.7 |
| 1890 | 6289 | Comms 9 | A.7 |
| 1892 | 6291 | Comms 10 | A.7 |
| 18BE | 6335 | Comms 32 (end address) | A.7 |

*Extended Comms Inputs (96 comms values max.)**

| Address Hex | Address Decimal | Description | See Appendix 51-52-25-66 |
|-------------|-----------------|---|--------------------------|
| 2440 | 9281 | Extended Comms Input 33 (start address) | A.7.1 |
| 2442 | 9283 | Extended Comms Input 34 | A.7.1 |
| 2444 | 9285 | Extended Comms Input 35 | A.7.1 |
| 2446 | 9287 | Extended Comms Input 36 | A.7.1 |
| 2448 | 9289 | Extended Comms Input 37 | A.7.1 |
| 244A | 9291 | Extended Comms Input 38 | A.7.1 |
| 244C | 9293 | Extended Comms Input 39 | A.7.1 |
| 244E | 9295 | Extended Comms Input 40 | A.7.1 |
| 2450 | 9299 | Extended Comms Input 41 | A.7.1 |
| 2452 | 9301 | Extended Comms Input 42 | A.7.1 |
| 24BE | 9407 | Extended Comms Input 96 (end address) | A.7.1 |

Modbus Memory Map Supplement:

* Communications Inputs can be set by using Modbus function code 16.

Pen Values (96 pens max.)

| Address Hex | Address Decimal | Description | See Appendix 51-52-25-66 |
|-------------|-----------------|-----------------------|--------------------------|
| 18C0 | 6337 | Pen 1 (start address) | A.8 |
| 18C2 | 6339 | Pen 2 | A.8 |
| 18C4 | 6341 | Pen 3 | A.8 |
| 18C6 | 6343 | Pen 4 | A.8 |
| 18C8 | 6345 | Pen 5 | A.8 |
| 18CA | 6347 | Pen 6 | A.8 |
| 18CC | 6349 | Pen 7 | A.8 |
| 18CE | 6351 | Pen 8 | A.8 |
| 18D0 | 6353 | Pen 9 | A.8 |
| 18D2 | 6355 | Pen 10 | A.8 |
| 197E | 6527 | Pen 96 (end address) | A.8 |

Totalisers (64 totalisers max.)

| Address Hex | Address Decimal | Description | See Appendix 51-52-25-66 |
|-------------|-----------------|------------------------------|--------------------------|
| 1B00 | 6913 | Totalisers 1 (start address) | A.10 |
| 1B02 | 6915 | Totalisers 2 | A.10 |
| 1B04 | 6917 | Totalisers 3 | A.10 |
| 1B06 | 6919 | Totalisers 4 | A.10 |
| 1B08 | 6921 | Totalisers 5 | A.10 |
| 1B0A | 6923 | Totalisers 6 | A.10 |
| 1B0C | 6925 | Totalisers 7 | A.10 |
| 1B0E | 6927 | Totalisers 8 | A.10 |
| 1B10 | 6929 | Totalisers 9 | A.10 |
| 1B12 | 6931 | Totalisers 10 | A.10 |
| 1B7E | 7039 | Totalisers 64 (end address) | A.10 |

Modbus Memory Map Supplement:

Alarm Value (96 Pens)

Allows you to read and write the value of the alarm level over Modbus. Table below shows Alarm 1 Pen 1 to Alarm 1 Pen 96

| Address Hex | Address Decimal | Description | See Appendix 51-52-25-66 |
|-------------|-----------------|-------------------------------------|--------------------------|
| 1C00 | 7169 | Alarm 1 Value Pen 1 (start address) | A.16 |
| 1C02 | 7171 | Alarm 1 Value Pen 2 | A.16 |
| 1C04 | 7173 | Alarm 1 Value Pen 3 | A.16 |
| 1C06 | 7175 | Alarm 1 Value Pen 4 | A.16 |
| 1C08 | 7177 | Alarm 1 Value Pen 5 | A.16 |
| 1C0A | 7179 | Alarm 1 Value Pen 6 | A.16 |
| 1C0C | 7181 | Alarm 1 Value Pen 7 | A.16 |
| 1C0E | 7183 | Alarm 1 Value Pen 8 | A.16 |
| 1C10 | 7185 | Alarm 1 Value Pen 9 | A.16 |
| 1C12 | 7187 | Alarm 1 Value Pen 10 | A.16 |
| 1CBE | 7359 | Alarm 1 Value Pen 96 | A.16 |

The address range continues from Alarm 2 up to Alarm 6, 96 pens for each alarm. EG. Alarm value 2 Pen 1-96, Alarm value 3 Pen 1-96, up to Alarm value 6 Pen 1-96. Table below shows Alarm value 1 to 6 start and end addresses for Pens 1 to 96.

| Address Hex | Address Decimal | Description | See Appendix 51-52-25-66 |
|-------------|-----------------|------------------------------------|--------------------------|
| 1C00 | 7169 | Alarm 1 Value Pen 1 | A.16 |
| 1CBE | 7359 | Alarm 1 Value Pen 96 | A.16 |
| 1CC0 | 7361 | Alarm 2 Value Pen 1 | A.16 |
| 1D7E | 7551 | Alarm 2 Value Pen 96 | A.16 |
| 1D80 | 7553 | Alarm 3 Value Pen 1 | A.16 |
| 1E3E | 7743 | Alarm 3 Value Pen 96 | A.16 |
| 1E40 | 7745 | Alarm 4 Value Pen 1 | A.16 |
| 1EFE | 7935 | Alarm 4 Value Pen 96 | A.16 |
| 1F00 | 7937 | Alarm5 Value Pen 1 | A.16 |
| 1FBE | 8127 | Alarm 5 Value Pen 96 | A.16 |
| 1FC0 | 8129 | Alarm 6 Value Pen 1 | A.16 |
| 207E | 8319 | Alarm 6 Value Pen 96 (end address) | A.16 |

Modbus Memory Map Supplement:

Alarm Status (96 Pens)

Allows you to read the status of all 6 alarms for each pen (up to 16 pens for **GR**).

| Address Hex | Address Decimal | Description | See Appendix 51-52-25-66 |
|-------------|-----------------|-------------------------------------|--------------------------|
| 1980 | 6529 | Alarm Status, Pen 1 (start address) | A.16.1 |
| 1981 | 6530 | Alarm Status, Pen 2 | A.16.1 |
| 1982 | 6531 | Alarm Status, Pen 3 | A.16.1 |
| 1983 | 6532 | Alarm Status, Pen 4 | A.16.1 |
| 1984 | 6533 | Alarm Status, Pen 5 | A.16.1 |
| 1985 | 6534 | Alarm Status, Pen 6 | A.16.1 |
| 1986 | 6535 | Alarm Status, Pen 7 | A.16.1 |
| 1987 | 6536 | Alarm Status, Pen 8 | A.16.1 |
| 1988 | 6537 | Alarm Status, Pen 9 | A.16.1 |
| 1989 | 6538 | Alarm Status, Pen 10 | A.16.1 |
| 19DF | 6624 | Alarm Status, Pen 96 (end address) | A.16.1 |

Alarm Status, continued

| |
|------------------|
| Bit 0 is Alarm 1 |
| Bit 1 is Alarm 2 |
| Bit 2 is Alarm 3 |
| Bit 3 is Alarm 4 |
| Bit 4 is Alarm 5 |
| Bit 5 is Alarm 6 |

this is decoded as follows...

| | | | | | | |
|--------------|---|---|---|---|----|----|
| Bit number | 0 | 1 | 2 | 3 | 4 | 5 |
| Alarm Number | 1 | 2 | 3 | 4 | 5 | 6 |
| Decimal | 1 | 2 | 4 | 8 | 16 | 32 |

So if you request the alarm status from Pen 1 and it returns the value 41, that number is made from $32 + 8 + 1$, i.e. bits 5, 3 and 0. In other words alarms 6, 4 and 1 are active.

Modbus Memory Map Supplement:

Totalisers

Totaliser values in engineering units, 4 byte IEEE floats using 2 Modbus registers per reading.

Input Text message

This facility allows a text message to be passed to the recorder to be annotated on the chart and added to the message log. The maximum length of the message is 32 bytes of ASCII characters, which need not be null-terminated.

It operates by utilising modbus function code 16 (0x10), Preset Multiple registers, and the unique address 0x0004 in the modbus global register map (Table A-1)

The modbus message format follows that shown in section 3.7 of the document cited. The Start Address will be 00 04, and the Byte Count of the number of bytes in the following text message. As 2 modbus registers are used to pass an address to function 16, the Number of Addresses has to be back calculated from the required Byte Count to give the lowest integer such that $(\text{Number of Addresses}) * 2 \geq \text{Byte Count}$.

For example if Byte Count = 4, then Number of Addresses = 2, but if Byte Count = 5, Number of Addresses = 3.

As an example, to send the 5-character message Start to a slave address 02 the complete message would be:

| Slave Address | Function Code | Start Addr. High | Start Addr. Low | No Addr. High | No Addr. Lo | Byte Count | Data | | | | | CRC | CRC |
|---------------|---------------|------------------|-----------------|---------------|-------------|------------|------|----|----|----|----|-----|-----|
| 02 | 10 | 00 | 04 | 00 | 03 | 05 | 53 | 74 | 61 | 72 | 74 | CRC | CRC |

The response follows the normal response for function code 16 given in section 3.7, and so to the above message the response would be: 02 10 00 04 00 03 CRC CRC

Analogue Input Value

Analogue readings in engineering units. 4byte IEEE floats using 2 Modbus registers per reading.

Communications Input

Values can be sent to the recorder for inclusion in the Maths Block, using command 16 up to 32 IEEE floats can be sent to the recorder. Using CV1 to CV32 in the Maths Block, these values can be displayed on the pens.

i.e. **P1 = CV1** will set Pen 1 to the engineering value set address 1880 with the function code 16. Once again these are 4 byte IEEE floats using 2 Modbus registers per reading.

Modbus Function Codes

These are described in document Modbus® Serial Communications User manual, 51-52-25-66.

Pages 14 to 25, inclusive. For **GR Series** recorders only use codes 01, 02, 03/04, 16 and 17.

Supplemental to Function code 16 with standard address 0004 can be used to send.

Supplemental to Function code 17, Report Device ID:

- Page 23 - Slave ID for **GR Series** recorders is always 05.
- Page 24 - Device description

| Item | Size in bytes | Contents |
|--------------------|---------------|---|
| Device Description | 16d, 0x10 | Recorder type+space+software version The length is extended to exactly 16 bytes by trailing 0x00 characters. Recorder type = is a combination of the OEM series name followed by the OEM device name (truncated to 16 characters) Software version is of the form nn.XX eg.00.FQ |

- Page 25 - Number of data block records, byte 23, always equals 05 for the Trendview range. data blocks are always in order.

00 = Analogue inputs, 02 = Digital inputs, 03 = Digital outputs, 06 = Pens, 09 = Totalisers.

Appendix K: Troubleshooting

Error Messages

Table 23.1 :

| Error Message | Code | LED Flash code | Description/Cause | Type |
|---|------|----------------|---|----------------------|
| Cannot read board hardware identity | 0 | 1,1 | An invalid/unsupported I/O card has been identified. Error reading board ID (type) - invalid board type configuration | Diagnostics Messages |
| Incompatible hardware ID | 0 | 1,1 | The number of channels reported by I/O board was invalid. Error reading board ID (type) - can't determine how many channels | Diagnostics Messages |
| Incompatible hardware ID | 1 | 1,1 | An invalid/unsupported I/O card has been identified. Invalid board type (setting up working variables) | Diagnostics Messages |
| Incompatible hardware ID | 2 | 1,1 | An invalid/unsupported I/O card has been identified. Invalid board type (getting board capability) | Diagnostics Messages |
| Incompatible hardware ID | 3 | 1,1 | An invalid/unsupported I/O card has been identified. Invalid board type (AcqTimer_OnInterrupt) | Diagnostics Messages |
| Incompatible hardware ID | 4 | 1,1 | An invalid/unsupported I/O card has been identified. Invalid board type on board initialisation | Diagnostics Messages |
| Incompatible hardware ID | 5 | 1,1 | An invalid/unsupported I/O card has been identified whilst reading life stats. Invalid board type when reading stats | Diagnostics Messages |
| Incompatible hardware ID | 6 | 1,1 | An invalid/unsupported I/O card has been identified whilst resetting life stats. Invalid board type resetting Life stats | Diagnostics Messages |
| Incompatible hardware ID | 7 | 1,1 | An invalid/unsupported I/O card has been identified. Invalid board type resetting Session stats | Diagnostics Messages |
| Incompatible hardware ID | 8 | 1,1 | An invalid/unsupported I/O card has been identified. Invalid board type finding history size | Diagnostics Messages |
| Incompatible hardware ID | 9 | 1,1 | An invalid/unsupported I/O card has been identified whilst getting life history. Invalid board type getting life history | Diagnostics Messages |
| Incompatible hardware ID | 10 | 1,1 | An invalid/unsupported I/O card has been identified whilst getting session history. | Diagnostics Messages |
| Incompatible hardware ID | 11 | 1,1 | An invalid/unsupported I/O card has been identified during writing life stats operation. | Diagnostics Messages |
| Incompatible hardware ID | 12 | 1,1 | An invalid/unsupported I/O card has been identified whilst in diagnostic mode. Invalid board type writing FieldPortDiagOutput | Diagnostics Messages |
| Unable to read board revision | 0 | 1,1 | Invalid or unsupported board revision for I/O board firmware. Error reading board revision: conversion request or reading value | Diagnostics Messages |
| Invalid board revision | 0 | 1,1 | Invalid or unsupported board revision for I/O board firmware. Error reading board revision: value read was not recognised | Diagnostics Messages |
| Board not marked as having passed post-mfr test | N/A | N/A | Board has not passed ATE test; return to factory | Diagnostics Messages |
| Unable to read valid configuration from E2 | N/A | N/A | Could not read a valid I/O board configuration | Diagnostics Messages |
| Unable to read history/stats from E2 | 0 | 3,3 | Could not read history or stats information from I/O card. Error reading board statistics. | Diagnostics Messages |

Error Messages

Table 23.1 :

| Error Message | Code | LED Flash code | Description/Cause | Type |
|--|------|----------------|---|----------------------|
| Fatal startup error | 0 | 1,1 | I/O board could not be initialized; suspect I/O board. Errors when trying to initialise board, after numerous attempts | Diagnostics Messages |
| H/W error prevents execution of command | 0 | 1,1 | AI board could not be initialized; suspect AI board. Failed to set acquisition interrupt timer, AI board | Diagnostics Messages |
| H/W error prevents execution of command | 0 | 1,1 | AI board could not be initialized; suspect AI board. Failed to set acquisition interrupt timer, AI board | Diagnostics Messages |
| H/W error prevents execution of command | 1 | 1,1 | PI board could not be initialized; suspect pulse board. Failed to set acquisition interrupt timer, PI board | Diagnostics Messages |
| H/W error prevents execution of command | 2 | 1,1 | DIO/AR board could not be initialized; suspect I/O board. Failed to set acquisition interrupt timer, DIO/AR boards | Diagnostics Messages |
| H/W error prevents execution of command | 3 | 1,1 | AO board could not be initialized; suspect AO board. Failed to set acquisition interrupt timer, AO board | Diagnostics Messages |
| H/W error prevents execution of command | 4 | 1,1 | Internal I/O card failure. Triggered Clock Monitor Failure | Diagnostics Messages |
| Function code received unknown | N/A | N/A | I/O card did not recognize the command sent to it. | Diagnostics Messages |
| The 2 fn code bytes failed validation test | N/A | N/A | I/O card did not recognize the command sent to it because the code and inverse code were different. | Diagnostics Messages |
| Slave still processing previous message | 0 | 2,2 | I/O board communications error. Character received from SPI when host should be waiting | Diagnostics Messages |
| Slave still processing previous message | 1 | 2,2 | I/O board field port/diagnostic communications error. Character received from FieldPort before ready for next command | Diagnostics Messages |
| Slave still processing previous message | 2 | 2,2 | I/O board communications error. Non-clocking char received from SPI when should be clocking reply | Diagnostics Messages |
| Cannot execute this command in present state | N/A | N/A | The command could not currently be executed, because the I/O card is in the wrong state to accept the command. | Diagnostics Messages |
| Wrong number of arguments for this message | N/A | N/A | The message sent to the I/O card was invalid: it had the wrong number of arguments | Diagnostics Messages |
| Arguments of the message were invalid | 0 | 4,4 | AI board could not be initialized; suspect AI board. Invalid frequency sent to SetAcqFreq | Diagnostics Messages |
| Arguments of the message were invalid | 1 | 4,4 | AI board could not be initialized; suspect AI board. Invalid frequency sent to GetAcqFreq | Diagnostics Messages |
| Arguments of the message were invalid | 2 | 4,4 | DIO board could not be initialized; suspect I/O board. Invalid mode sent to FlagIntPulseChan | Diagnostics Messages |
| Arguments of the message were invalid | 3 | 4,4 | Illegal channel number requested in message. Invalid channel number sent to SetAcqTimerFreq | Diagnostics Messages |
| Arguments of the message were invalid | 4 | 4,4 | Config change message can not change to raw mode acquisition. Attempted to set raw mode via config change - use SetRaw-Mode | Diagnostics Messages |
| Arguments of the message were invalid | 5 | 4,4 | Active burnout was selected on a channel configured as a RT. Attempted to set active burnout with RT input | Diagnostics Messages |

Error Messages

Table 23.1 :

| Error Message | Code | LED Flash code | Description/Cause | Type |
|--|------|----------------|--|----------------------|
| The message had an invalid CRC | N/A | N/A | The message sent to the I/O does not match it's CRC. | Diagnostics Messages |
| The message was incomplete | N/A | N/A | A incomplete message was detected by the I/O card | Diagnostics Messages |
| The configuration operation was not successful | N/A | N/A | General failure of an operation that queried or changed configuration | Diagnostics Messages |
| Unable to determine firmware version number | N/A | N/A | Unable to determine the firmware revision number, so some functions may not operate correctly | Diagnostics Messages |
| Unable to determine firmware build number | N/A | N/A | Unable to determine the firmware build number. | Diagnostics Messages |
| Unable to determine the firmware serial number | N/A | N/A | Unable to determine the firmware serial number. | Diagnostics Messages |
| Unable to determine the board's GUID | N/A | N/A | Unable to determine the firmware revision number given when first ATE tested. | Diagnostics Messages |
| Unable to determine the life history | N/A | N/A | The life history is not available from card. | Diagnostics Messages |
| Failure writing output value | 0 | 1,1 | There was an error setting the specified AO channel output value. Note that subsequent writes may succeed. Problem writing AO value detected: first attempt to send failed. | Diagnostics Messages |
| Failure writing output value | 1 | 1,1 | There was an error setting the specified AO channel output value (on the second occasion). Note that subsequent writes may succeed. Problem writing AO value detected: second attempt also failed. | Diagnostics Messages |
| Failure writing output value | 2 | 1,1 | There was an error setting the specified AO channel output value because the last selected channel was not deselected first. Problem writing AO value detected: last channel wasn't deselected | Diagnostics Messages |
| Failure writing output value | 3 | 1,1 | Failed to set the identified AI channel correctly for acquisition in ChangeRange command. Failed writing AI ADC values | Diagnostics Messages |
| Failure writing output value | 4 | 1,1 | Failed to set the identified AI channel correctly for acquisition in ChangeAcqFreq command. Failed writing AI ADC values | Diagnostics Messages |
| Failure writing output value | 5 | 1,1 | Failed to set the identified AI channel correctly for acquisition in SetMainsF command. Failed writing AI ADC values | Diagnostics Messages |
| Failure writing output value | 6 | 1,1 | Failed to set the identified AI channel correctly for acquisition (attempting restore in ChangeAcqFreq). Failed writing AI ADC values | Diagnostics Messages |
| Failure writing output value | 7 | 1,1 | Failed to set the identified AI channel correctly for acquisition (attempting restore in ChangeRange). Failed writing AI ADC values | Diagnostics Messages |
| Failure writing output value | 8 | 1,1 | Failed to set the identified AI channel correctly for acquisition in WriteAIConfig command. Failed writing AI ADC values | Diagnostics Messages |
| Failure writing output value | 9 | 1,1 | Failed to set the identified AI channel correctly for acquisition in WriteAIChanConfig command. Failed writing AI ADC values | Diagnostics Messages |

Error Messages

Table 23.1 :

| Error Message | Code | LED Flash code | Description/Cause | Type |
|--|------|----------------|---|----------------------|
| Failure writing output value | 10 | 1,1 | Failed to set the identified AI channel correctly for acquisition in SetActiveBurnout command. Failed writing AI ADC values | Diagnostics Messages |
| Failure writing output value | 11 | 1,1 | Cannot turn ohms measurement current off; suspect AI board. Failed writing AI ADC values in TurnRTCurrOff command | Diagnostics Messages |
| An error has occurred during calibration | N/A | N/A | An error has occurred during factory or user calibration. | Diagnostics Messages |
| Unable to return all or part of cal - may be corrupt | N/A | N/A | Some or all of the calibration data was corrupt, so none could be returned | Diagnostics Messages |
| Error during I/O board start-up | N/A | N/A | An error occurred during I/O card startup | Diagnostics Messages |
| The reply message larger than buffer | N/A | N/A | The I/O card reply was longer than allowed and so overflowed the buffer. | Diagnostics Messages |
| Unable to read configuration | 0 | 3,3 | General error; one or more values could not be read from the EEPROM. Error reading long value from EEPROM | Diagnostics Messages |
| Unable to read configuration | 1 | 3,3 | The stored AI configuration could not be read on power-up. Error reading AI config from EEPROM on power-up | Diagnostics Messages |
| Unable to read configuration | 2 | 3,3 | The stored AO configuration could not be read on power-up. Error reading AO config from EEPROM on power-up | Diagnostics Messages |
| Unable to read configuration | 3 | 3,3 | The stored digital/pulse configuration could not be read on power-up. Error reading DIG config from EEPROM on power-up | Diagnostics Messages |
| Unable to write configuration | 0 | 3,3 | The default board configuration could not be written on power-up. Error writing Board Setup to EEPROM on power-up | Diagnostics Messages |
| Unable to write configuration | 1 | 3,3 | The AI configuration could not be written to EEPROM on configuration change. Error writing AI config to EEPROM | Diagnostics Messages |
| Unable to write configuration | 2 | 3,3 | The AI configuration could not be written to EEPROM on configuration change. Error writing AO config to EEPROM | Diagnostics Messages |
| Unable to write configuration | 3 | 3,3 | The digital configuration could not be written to EEPROM on configuration change. Error writing DIG config to EEPROM | Diagnostics Messages |
| Unable to write configuration | 4 | 3,3 | The AI configuration could not be written on configuration change. Error writing AI config to EEPROM | Diagnostics Messages |
| Unable to write configuration | 5 | 3,3 | The AO configuration could not be written on configuration change. Error writing AO config to EEPROM | Diagnostics Messages |
| Unable to write configuration | 6 | 3,3 | The digital/pulse configuration could not be written on configuration change. Error writing DIG config to EEPROM | Diagnostics Messages |
| Unable to write configuration | 7 | 3,3 | The AI configuration could not be written on configuration change after ChangeRange command. Error writing AI config to EEPROM | Diagnostics Messages |
| Unable to write configuration | 8 | 3,3 | The AI configuration could not be written on configuration change after ChangeAcqFreq command. Error writing AI config to EEPROM | Diagnostics Messages |
| Unable to write configuration | 9 | 3,3 | The AI configuration could not be written on configuration change after SetDiagInterval command. Error writing AI setup to EEPROM | Diagnostics Messages |

Error Messages

Table 23.1 :

| Error Message | Code | LED Flash code | Description/Cause | Type |
|-------------------------------|------|----------------|---|----------------------|
| Unable to write configuration | 10 | 3,3 | The AI configuration could not be written on configuration change after SetBdTestData command. Error writing AI setup to EEPROM | Diagnostics Messages |
| Unable to write configuration | 11 | 3,3 | The AI configuration could not be written on configuration change after SetBdGuid command. Error writing AI setup to EEPROM | Diagnostics Messages |
| Unable to write configuration | 12 | 3,3 | The AI configuration could not be written on configuration change after WrAIConfig command. Error writing AI config to EEPROM | Diagnostics Messages |
| Unable to write configuration | 13 | 3,3 | The AI configuration could not be written on configuration change after WrAIChanConfig command. Error writing AI config to EEPROM | Diagnostics Messages |
| Unable to write configuration | 14 | 3,3 | The AI configuration could not be written on configuration change after WrBoardSetup command. Error writing AI setup to EEPROM | Diagnostics Messages |
| Unable to write configuration | 15 | 3,3 | The AI configuration could not be written on configuration change after SetMainsF command Error writing AI setup to EEPROM | Diagnostics Messages |
| Unable to write configuration | 16 | 3,3 | The digital configuration could not be written on configuration change after WrDigConfig command. Error writing DIG Cfg to EEPROM | Diagnostics Messages |
| Unable to write configuration | 17 | 3,3 | The AO configuration could not be written on configuration change after WrAOConfig command. Error writing AO Cfg to EEPROM | Diagnostics Messages |
| Unable to write configuration | 18 | 3,3 | The AI configuration could not be written on configuration change after SetActiveBnout command. Error writing AI Cfg to EEPROM | Diagnostics Messages |
| Watchdog timer timed out | 0 | 4,4 | COP I/O Watchdog timer timeout; I/O board has failed. COP Failure was triggered | Diagnostics Messages |
| Error reading NV (EEPROM) | 0 | 3,3 | The I/O board serial number could not be identified by the I/O firmware. Error reading Board ID (serial number): couldn't read EEPROM | Diagnostics Messages |
| Error reading NV (EEPROM) | 1 | 3,3 | I/O board setup information could not be read. Error reading Board Setup: couldn't read EEPROM | Diagnostics Messages |
| Error reading NV (EEPROM) | 2 | 3,3 | The AI card calibration history could not be read on power-up. Error reading AI calibration history from EEPROM on power-up | Diagnostics Messages |
| Error reading NV (EEPROM) | 3 | 3,3 | The AO card calibration history could not be read on power-up. Error reading AO calibration from EEPROM on power-up | Diagnostics Messages |
| Error reading NV (EEPROM) | 4 | 3,3 | The AO card calibration history could not be read. Error reading AO calibration history from EEPROM | Diagnostics Messages |
| Error reading NV (EEPROM) | 5 | 3,3 | I/O board could not correctly determine whether this is the first time this board has been powered-up, so could not default the values. Error reading FirstPower-up signature from EEPROM | Diagnostics Messages |
| Error reading NV (EEPROM) | 6 | 3,3 | Could not read the initial resistance held for active burnout. Error reading Initial loop resistance from EEPROM | Diagnostics Messages |
| Error reading NV (EEPROM) | 7 | 3,3 | Could not read the current resistance held for active burnout. Error reading Current loop resistance from EEPROM | Diagnostics Messages |

Error Messages

Table 23.1 :

| Error Message | Code | LED Flash code | Description/Cause | Type |
|------------------------------|------|----------------|---|----------------------|
| Error writing to NV (EEPROM) | 0 | 3,3 | General error writing persistent data (EEWriteLong). Error writing data to EEPROM | Diagnostics Messages |
| Error writing to NV (EEPROM) | 1 | 3,3 | I/O board has completed first-time power-up defaulting; however could not log the fact. Error writing FirstPower-up signature to EEPROM | Diagnostics Messages |
| Error writing to NV (EEPROM) | 2 | 3,3 | Life stats could not be persisted on I/O card. Error writing to Life Stats in EEPROM | Diagnostics Messages |
| Error writing to NV (EEPROM) | 3 | 3,3 | Board stats could not be persisted on AI card. Error writing to AI Board Stats in EEPROM | Diagnostics Messages |
| Error writing to NV (EEPROM) | 4 | 3,3 | Board calibration could not be persisted on AI card (ReadDefaultAICal). Error writing AI calibration to EEPROM | Diagnostics Messages |
| Error writing to NV (EEPROM) | 5 | 3,3 | Board calibration history could not be persisted on AI card (MakeEmptyAICalHist). Error writing AI calibration history to EE | Diagnostics Messages |
| Error writing to NV (EEPROM) | 6 | 3,3 | Board calibration history could not be persisted on AI card. Error writing AI calibration history to EEPROM | Diagnostics Messages |
| Error writing to NV (EEPROM) | 7 | 3,3 | Board stats could not be persisted on AO card. Error writing to AO Board Stats in EEPROM | Diagnostics Messages |
| Error writing to NV (EEPROM) | 8 | 3,3 | Board calibration could not be persisted on AO card (ReadDefaultAOCal). Error writing AO calibration data to EE | Diagnostics Messages |
| Error writing to NV (EEPROM) | 9 | 3,3 | Board calibration could not be persisted on AO card (MakeEmptyAOCalHist). Error writing AO calibration history to EE | Diagnostics Messages |
| Error writing to NV (EEPROM) | 10 | 3,3 | Board calibration history could not be persisted on AO card. Error writing AO calibration history to EEPROM | Diagnostics Messages |
| Error writing to NV (EEPROM) | 11 | 3,3 | Board stats could not be persisted on digital I/O card. Error writing to DIO Board Stats in EEPROM | Diagnostics Messages |
| Error writing to NV (EEPROM) | 12 | 3,3 | Board stats could not be persisted on alarm card Error writing to AR Board Stats in EEPROM | Diagnostics Messages |
| Error writing to NV (EEPROM) | 13 | 3,3 | Board stats could not be persisted on pulse card Error writing to PI Board Stats in EEPROM | Diagnostics Messages |
| Error writing to NV (EEPROM) | 14 | 3,3 | The I/O board serial number could not be saved Error writing Board ID to EEPROM | Diagnostics Messages |
| Error writing to NV (EEPROM) | 15 | 3,3 | The I/O board calibration information could not be saved. Error writing Board Calibration to EEPROM | Diagnostics Messages |
| Error writing to NV (EEPROM) | 16 | 3,3 | The I/O board stats information could not be saved. Error writing Stats to EEPROM | Diagnostics Messages |
| Error writing to NV (EEPROM) | 17 | 3,3 | The AO board calibration information could not be saved. Error writing AO Cal values to EEPROM | Diagnostics Messages |
| Error writing to NV (EEPROM) | 18 | 3,3 | The AO board calibration defaults could not be saved. Error writing defaults to AO cal history in EEPROM | Diagnostics Messages |
| Error writing to NV (EEPROM) | 19 | 3,3 | Could not write the initial resistance held for active burnout. Error writing AI loop resistance to EEPROM at start-up | Diagnostics Messages |

Error Messages

Table 23.1 :

| Error Message | Code | LED Flash code | Description/Cause | Type |
|--|------|----------------|---|----------------------|
| Error writing to NV (EEPROM) | 20 | 3,3 | Could not write the current resistance held for active burnout. Error writing AI Current loop resistance to EEPROM | Diagnostics Messages |
| Error writing to NV (EEPROM) | 21 | 3,3 | Could not write the initial resistance held for active burnout. Error writing AI Initial loop resistance to EEPROM | Diagnostics Messages |
| No board serial number on power-up | 0 | 3,3 | The I/O board serial number could not be confirmed as correct. Error reading Board ID (serial number): failed CRC check | Diagnostics Messages |
| CRC error on reading setup from NV memory (EEPROM) | 1 | 3,3 | The setup file stored on the I/O board has become corrupted. Error reading Board Setup: failed CRC check | Diagnostics Messages |
| There are readings missing from channel | 0 | 4,4 | 50Hz acquisition is not possible whilst active burnout is selected. 10Hz operation is the maximum. 50Hz acquisition with active burnout caused lost readings - use 10Hz max | Diagnostics Messages |
| More data than buffer can hold; some overwritten | N/A | N/A | More data than buffer can hold, only part returned; but some has also been overwritten | Diagnostics Messages |
| Can't execute: invalid state | 0 | 4,4 | The stored calibration is for an illegal range Invalid gain in Read-WorkingCals | Diagnostics Messages |
| Can't execute: invalid state | 1 | 4,4 | The I/O card internal state is unable to take a CJC reading. Invalid state in CJC state machine on AI board | Diagnostics Messages |
| Can't execute: invalid state | 2 | 4,4 | The I/O card internal state is unable to take read/operate a digital. Invalid state relating to DIG board pointer update | Diagnostics Messages |
| Can't execute: invalid state | 3 | 4,4 | The I/O card internal state is unable to take a reading for all AI channels. Invalid state of AdcStatus for SPI master (AI board) | Diagnostics Messages |
| Can't execute: invalid state | 4 | 4,4 | The I/O card internal state is unable to update for all AO channels. Invalid state of DacStatus - SPI master (AO board) | Diagnostics Messages |
| Can't execute: invalid state | 5 | 4,4 | The I/O card internal state is unable to take a reading for all AI channels. Invalid state of ReadingType (AI board) | Diagnostics Messages |
| Can't execute: invalid state | 6 | 4,4 | The communications to the I/O card have failed due to the I/O cards internal state. Invalid state of MessageStatus (Host or FieldPort) | Diagnostics Messages |
| Can't execute: invalid state | 7 | 4,4 | Error whilst making an active burnout measurement. Invalid state of Active Burnout measurement type | Diagnostics Messages |
| Can't execute: invalid state | 8 | 4,4 | Error whilst making an active burnout measurement. Invalid state of gain in Active Burnout calculation | Diagnostics Messages |
| Unable to execute: unspecified reason | 0 | 4,4 | The measured pulse frequency is too high for the digital I/O board; try using a dedicated pulse card channel. | Diagnostics Messages |
| Unable to execute: unspecified reason | 1 | 4,4 | The command referenced an illegal/invalid board channel number on the DIO board | Diagnostics Messages |
| Unable to execute: unspecified reason | 2 | 4,4 | I/O card is not able to operate on SPI bus Invalid board type for SPI master function | Diagnostics Messages |
| Unable to execute: unspecified reason | 3 | 4,4 | An illegal operation on the I/O board firmware was found. | Diagnostics Messages |

Error Messages

Table 23.1 :

| Error Message | Code | LED Flash code | Description/Cause | Type |
|---|------|----------------|--|----------------------|
| Unable to execute: unspecified reason | 4 | 4,4 | Error sending data to SPI for AI Active Burnout readings | Diagnostics Messages |
| Unable to execute: unspecified reason | 5 | 4,4 | Data received for AI Active Burnout indicates an error condition | Diagnostics Messages |
| Unable to execute: unspecified reason | 6 | 4,4 | Error ADC not ready while taking Active Burnout readings | Diagnostics Messages |
| Unable to execute: unspecified reason | 7 | 4,4 | Could not initialise active burnout - will try again next power-up | Diagnostics Messages |
| Unspecified error has occurred | N/A | N/A | I/O card failure: An unspecified error has occurred | Diagnostics Messages |
| Unable to enable or disable timer interrupts | N/A | N/A | I/O card failure: Unable to enable or disable timer interrupts | Diagnostics Messages |
| Error with RS232 port | 0 | 2,2 | Diagnostic FieldPort OverRun error | Diagnostics Messages |
| Error with RS232 port | 1 | 2,2 | Diagnostic FieldPort Framing error | Diagnostics Messages |
| Error with RS232 port | 3 | 2,2 | Diagnostic FieldPort Receive Buffer | Diagnostics Messages |
| Error with RS232 port | 4 | 2,2 | Diagnostic FieldPort Noise error | Diagnostics Messages |
| Error with RS232 port | 5 | 2,2 | Diagnostic FieldPort Idle error | Diagnostics Messages |
| Error with Host SPI | 0 | 2,2 | Host SPI Port OverRun error | Diagnostics Messages |
| Error with Host SPI | 1 | 2,2 | Host SPI Port Receive Buffer Overflow error | Diagnostics Messages |
| Error with Host SPI | 2 | 2,2 | Host SPI Port Software Receive Buffer Overflowed | Diagnostics Messages |
| Master SPI (ADC or DAC) Receive buffer overflowed | 0 | 1,1 | Master SPI (Adc or Dac) Receive Buffer overflowed and was reset | Diagnostics Messages |
| Clock monitor failure occurred | N/A | N/A | The I/O card clock monitor failed. | Diagnostics Messages |
| Error with master SPI (ADC or DAC) | 0 | 1,1 | Master SPI (Adc or Dac) Over-run error | Diagnostics Messages |
| Error with master SPI (ADC or DAC) | 1 | 1,1 | Master SPI (Adc or Dac) Receive Buffer Overflow error | Diagnostics Messages |
| Waited too long without response | 0 | 4,4 | I/O card has timed out waiting for SPITransfer | Diagnostics Messages |
| Waited too long without response | 1 | 4,4 | I/O card has timed out waiting for AdcSpiSend | Diagnostics Messages |
| Waited too long without response | 2 | 4,4 | I/O card has timed out waiting for ResetADC | Diagnostics Messages |

Error Messages

Table 23.1 :

| Error Message | Code | LED Flash code | Description/Cause | Type |
|---|------|----------------|--|----------------------|
| Waited too long without response | 3 | 4,4 | I/O card has timed out waiting for CheckSelectedAD | Diagnostics Messages |
| An error has occurred with channel | N/A | N/A | General error that the I/O card channel specified has failed to make a measurement or set the output. | Diagnostics Messages |
| Calib vals not written properly in factory or field cal | 0 | 3,3 | The calibration values written in factory or field calibration could not be read. Reading EEPROM calcs failed, so did attempted default read | Diagnostics Messages |
| CJC port error detected | 0 | 1,1 | Communications to the CJC failed, subsequent retries may have succeeded. CJC driver OverRun error | Diagnostics Messages |
| CJC port error detected | 1 | 1,1 | Communications to the CJC failed, subsequent retries may have succeeded. CJC driver Framing error | Diagnostics Messages |
| CJC port error detected | 2 | 1,1 | Communications to the CJC failed, subsequent retries may have succeeded. CJC driver Parity error | Diagnostics Messages |
| CJC port error detected | 3 | 1,1 | Communications to the CJC failed, subsequent retries may have succeeded. CJC driver Receive Buffer Overflow error | Diagnostics Messages |
| CJC port error detected | 4 | 1,1 | Communications to the CJC failed, subsequent retries may have succeeded. CJC driver Noise error | Diagnostics Messages |
| CJC port error detected | 5 | 1,1 | Communications to the CJC failed, subsequent retries may have succeeded. CJC driver Idle error | Diagnostics Messages |
| Cannot enable ADC chip | 0 | 4,4 | The I/O card internal and/or external communications have failed to be initialized correctly. Failed to configure and enable SPI master | Diagnostics Messages |
| Cannot enable ADC chip | 1 | 4,4 | Failed to initialize the CJC driver. Failed to enable CJC Driver | Diagnostics Messages |
| Can't initialise the SPI for ADCs | N/A | N/A | General error that the I/O card channel specified has failed to make a measurement. | Diagnostics Messages |
| Can't initialise ADC speeds, ranges, etc | 0 | 1,1 | One or more measurements on an AI channel have failed. Error selecting input pair on initialisation of AI board | Diagnostics Messages |
| Can't initialise ADC speeds, ranges, etc | 1 | 1,1 | One or more measurements on an AI channel have failed. Error setting relays (P1, P2) on initialisation of AI board | Diagnostics Messages |
| Can't initialise ADC speeds, ranges, etc | 2 | 1,1 | An invalid configuration has been sent to the AI board. Error setting filter value on initialisation of AI board | Diagnostics Messages |
| Can't initialise ADC speeds, ranges, etc | 3 | 1,1 | An AI channel could not be reset on the AI board. Error while resetting ADCs - more detail on channel specific faults | Diagnostics Messages |
| Can't initialise ADC speeds, ranges, etc | 4 | 1,1 | An AI channel could not be initialized on the AI. Error initialising an ADC channel | Diagnostics Messages |
| Can't initialise the CJC | 0 | 1,2 | CJC failed to initialize. Check that CJC is fitted. Failed several attempts to initialise CJC device on AI board | Diagnostics Messages |
| ADC not ready for requested op chan | 0 | 4,4 | ADC conversion timed out - perhaps ADC filter value too slow for acq. Rate. ADC not ready | Diagnostics Messages |
| Failed to reset ADC converters | 0 | 1,1 | An AI channel cannot be reset correctly. Failed to reset ADC on AI board | Diagnostics Messages |

Error Messages

Table 23.1 :

| Error Message | Code | LED Flash code | Description/Cause | Type |
|--|------|----------------|--|----------------------|
| Factory cal read from EEPROM was corrupt on power-up | 0 | 3,3 | An error occurred whilst reading the factory calibration on power-up; return to factory or try user calibrating. Error reading an AI factory calibration from EEPROM on power-up | Diagnostics Messages |
| Factory RT cal read from EEPROM was corrupt on power-up | 1 | 3,3 | An error occurred whilst reading the RT calibration on power-up; return to factory. Error reading AI RT calibration from EEPROM on power-up | Diagnostics Messages |
| User cal read from EEPROM was corrupt on power-up | 0 | 3,3 | An error occurred whilst reading the user calibration on power-up; try re-user calibrating Error reading an AI user calibration from EEPROM on power-up | Diagnostics Messages |
| User cal read from EEPROM was corrupt on power-up | 1 | 3,3 | Several errors occurred whilst reading the user calibration on power-up; try re-user calibrating Multiple errors reading AI user cal on power-up: factory calibrations set | Diagnostics Messages |
| Both calcs read from EEPROM were corrupt | N/A | N/A | Both factory and user calibrations read from EEPROM were corrupt | Diagnostics Messages |
| There is no CJC reading available | N/A | N/A | There is no CJC reading available | Diagnostics Messages |
| The last CJC value was not read correctly | N/A | N/A | The last CJC value was not read correctly | Diagnostics Messages |
| ADC chip failed self test chan | 0 | 1,1 | Did not pass the self test - value read wasn't the expected default on given channel. | Diagnostics Messages |
| Detected open circuit load on an enabled AO channel | N/A | N/A | The AO channel has an O/C load i.e. load has been removed. | Diagnostics Messages |
| Requested more than 21mA output | N/A | N/A | The AO channel has been requested to retransmit >21mA. | Diagnostics Messages |
| Ambient temperature out of limits | N/A | N/A | The AI card ambient temperature is outside of operating limits | Diagnostics Messages |
| Active burnout almost failed on AI channel | N/A | N/A | The T/C on the specified AI channel has almost burnout, however a value can still be measured (T/C almost failed O/C). | Diagnostics Messages |
| Active burnout S/C detected on AI channel | N/A | N/A | The T/C on the specified AI channel has burnout (failed O/C) whilst set to active burnout mode. | Diagnostics Messages |
| Active burnout degraded on AI channel | N/A | N/A | The T/C on the specified AI channel has degraded performance, however a value can still be measured. | Diagnostics Messages |
| Out of burnout on AI channel | N/A | N/A | The T/C on the specified AI channel has recovered from a burnout condition. Suspect a bad connection/failing T/C. | Diagnostics Messages |
| Upscale burnout on AI channel | N/A | N/A | The T/C on the specified AI channel has burnout (failed O/C). The pen has gone upscale as stated in the setup. | Diagnostics Messages |
| Downscale burnout on AI channel | N/A | N/A | The T/C on the specified AI channel has burnout (failed O/C). The pen has gone downscale as stated in the setup. | Diagnostics Messages |
| AI channel dual point compensation error, using single point 1 | N/A | N/A | Dual point compensation was specified, but one or more points were invalid therefore setup has been defaulted to single point compensation using point 1. | Diagnostics Messages |
| AI channel: User analogue high and low limits are same | N/A | N/A | User limits were required for the specified analogue channel; however both limits were incorrectly detected with the value. | Diagnostics Messages |

Error Messages

Table 23.1 :

| Error Message | Code | LED Flash code | Description/Cause | Type |
|---|------|----------------|---|----------------------|
| AI channel; removing fast scanning support | N/A | N/A | Fast scanning option is disabled or is illegal for board/channel, but was specified in the setup file | Diagnostics Messages |
| AI channel; updating illegal acquisition rate | N/A | N/A | The acquisition rate specified in the setup for an AI channel was not allowed for board and option selected | Diagnostics Messages |
| AO channel; incorrect retransmit pen | N/A | N/A | The setup for the given AO channel specified an invalid pen to retransmit. | Diagnostics Messages |
| Slot number of channels changed – x channels previously; currently y channels | N/A | N/A | The I/O card is the same type as that run previously, however has a different number of channels. This will be as a result of a board upgrade /downgrade. | Diagnostics Messages |
| Slot setup mismatch: AO in setup; updating to AI | N/A | N/A | An AO board was detected on the previous run, but now an AI board has been detected, therefore the AI setup will be used instead of the AO. | Diagnostics Messages |
| Slot setup mismatch: AO in setup; updating to Pulse | N/A | N/A | An AO board was detected on the previous run, but now a pulse board has been detected, therefore the pulse setup will be used instead of the AO. | Diagnostics Messages |
| Slot setup mismatch: AI in setup; updating to AO | N/A | N/A | An AI board was detected on the previous run, but now an AO board has been detected, therefore the AO setup will be used instead of the AI. | Diagnostics Messages |
| Slot setup mismatch: AI in setup; updating to Pulse | N/A | N/A | An AI board was detected on the previous run, but now a pulse board has been detected, therefore the pulse setup will be used instead of the AI. | Diagnostics Messages |
| Slot setup mismatch: Pulse in setup; updating to AI | N/A | N/A | A pulse board was detected on the previous run, but now an AI board has been detected, therefore the AI setup will be used instead of the pulse. | Diagnostics Messages |
| Slot setup mismatch: Pulse in setup; updating to AO | N/A | N/A | A pulse board was detected on the previous run, but now an AO board has been detected, therefore the AO setup will be used instead of the pulse. | Diagnostics Messages |
| Slot setup mismatch: DIO in setup; updating to Alarm | N/A | N/A | A DIO board was detected on the previous run, but now an alarm board has been detected, therefore the alarm setup will be used instead of the DIO. | Diagnostics Messages |
| Slot setup mismatch: Alarm in setup; updating to DIO | N/A | N/A | An alarm board was detected on the previous run, but now a DIO board has been detected, therefore the DIO setup will be used instead of the alarm. | Diagnostics Messages |
| Slot setup unspecified for AI card | N/A | N/A | A warning that a new AI board has been fitted. | Diagnostics Messages |
| Slot setup unspecified for AO card | N/A | N/A | A warning that a new AO board has been fitted. | Diagnostics Messages |
| Slot setup unspecified for pulse card | N/A | N/A | A warning that a new pulse board has been fitted. | Diagnostics Messages |
| Slot setup unspecified for DIO card | N/A | N/A | A warning that a new DIO board has been fitted. | Diagnostics Messages |
| Slot setup unspecified for Alarm card | N/A | N/A | A warning that a new alarm board has been fitted. | Diagnostics Messages |

Error Messages

Table 23.1 :

| Error Message | Code | LED Flash code | Description/Cause | Type |
|---|-------------|-----------------------|---|--|
| Firmware upgrade | N/A | N/A | Notification that the recorder has just detected that the software has been upgraded from the last successful run | System Status and Messages |
| Configuration Loaded | N/A | N/A | Notification that the configuration has been successfully loaded | System Status and Messages |
| Setup Changed | N/A | N/A | Notification that the user has changed one or more items on the recorder setup | System Status and Messages |
| Pen x using scripts but option not available | N/A | N/A | Scripts are selected on Pen X, but the recorder options disables scripts | Diagnostics and System Status and Messages |
| Invalid number format. Exponential numbers must be entered in the format 1.23E-12 | N/A | N/A | The number entered was not in the correct format. | Diagnostics Status DIO and Messages |
| AUTO OPS - Failed to load remotely uploaded configuration | N/A | N/A | Configuration remote download has failed. | |
| Configuration remotely loaded | N/A | N/A | Configuration has been remotely downloaded successfully. | System Status and Messages |
| FTP transfer operation time-out failure | N/A | N/A | The requested FTP operation has timed out. | System Status and Messages |
| FTP transfer operation failed | N/A | N/A | The requested FTP operation has failed. | System Status and Messages |
| FTP transfer finished successfully | N/A | N/A | The requested FTP operation has completed successfully. | System Status and Messages |
| Scheduled Export data performed | N/A | N/A | The scheduled data export completed successfully | System Status and Messages |
| Media Missing | N/A | N/A | Report that the specified media is not inserted | System Status and Messages |
| Media Full | N/A | N/A | Report that the specified media is full | System Status and Messages |
| Scheduled export failed - media removed during export | N/A | N/A | The scheduled export failed because the media was removed during transfer operation. | System Status and Messages |
| Scheduled export failed - unknown media error | N/A | N/A | The scheduled export failed because of an unknown cause | System Status and Messages |
| Scheduled export failed - could not create export folder | N/A | N/A | The scheduled export failed because the export folder was not present and could not be created. | System Status and Messages |
| Scheduled export failed - no media present | N/A | N/A | The scheduled export has failed because no media is present | System Status and Messages |
| Media space too low for next scheduled data transfer | N/A | N/A | The space available on the media is too little for the next scheduled operation | System Status and Messages |

Error Messages

Table 23.1 :

| Error Message | Code | LED Flash code | Description/Cause | Type |
|--|------|----------------|---|--|
| Unable to load | N/A | N/A | Unable to load requested file | Diagnostics and System Status and Messages |
| Message time earlier than oldest chart data | N/A | N/A | No chart data exists for time of message (the data blocks have been recycled) | System Status and Messages |
| Layout not valid or incorrect recorder type | N/A | N/A | Layout specified is invalid or invalid for the recorder type that it is trying to be used on | System Status and Messages |
| Recorder now operating in daylight saving time | N/A | N/A | Notification that the recorder is now operating in daylight saving mode | System Status and Messages |
| Recorder now operating in standard time | N/A | N/A | Notification that the recorder is now operating in standard time mode | System Status and Messages |
| Setup error | N/A | N/A | An unrecoverable error was found in the recorder setup file. | System Status and Messages |
| Reset Passwords | N/A | N/A | The passwords held in the recorder have been deleted. | |
| This user is not permitted to log in at this time | N/A | N/A | The user is not allowed to log on because it is outside of their time allocation. | |
| You must have at least one top level user in the system if passwords are enabled | N/A | N/A | There must be at least one administrator user when passwords are enabled. | |
| Reset password data to factory default. This will invoke a recorder restart | N/A | N/A | A prompt to tell the user that resetting the passwords to the factory default will automatically cause the recorder to restart. | |
| Login Failed | N/A | N/A | General fail message, specific cause has already been identified previously. | |
| Login has failed: Error Unknown | N/A | N/A | General fail message, specific cause could not be identified. | |
| Policy Failed - Password configuration unsuccessful | N/A | N/A | Password system has failed to start-up correctly because of a problem with the configuration | |
| This account needs to be reset by an administrator | N/A | N/A | This account must be reset by someone with administrator authorization | |
| Access Denied to Area | N/A | N/A | Access to the area that the operator tried to access is refused because the operator has not got the authority level necessary | |
| Password Failure | N/A | N/A | User has tried to login and has failed. | |
| Inactivity Timeout | N/A | N/A | Recorder inactivity has timed the current user out; so the user must re-log on. | |
| Unknown Password Error | N/A | N/A | Password system has failed to start-up correctly for an unknown reason | |
| Supplied username contains space characters | N/A | N/A | A username cannot contain space characters. | |
| DPPQ - FATAL ERROR - DATA LOSS | N/A | N/A | Acquired I/O card data has been lost | Diagnostics Status IO and Messages |

Error Messages

Table 23.1 :

| Error Message | Code | LED Flash code | Description/Cause | Type |
|-------------------------------------|------|----------------|---|----------------------------|
| Data reset has been performed | N/A | N/A | The data held internally has been deleted | System Status and Messages |
| The touch screen was NOT calibrated | N/A | N/A | The touch screen requires calibration | System Status and Messages |

Appendix L: GR Series AMS2750 capabilities

AMS2750 and the GR Series Recorders

The recorders can operate in 2 Modes:

1. Temperature Uniformity Survey (TUS) – Stand alone recorder that measures T/Cs in oven/furnace, only available on an **Multitrend GR** and **DR Graphic** recorder.
2. Process mode – Screen & Timers. Program when next survey and calibration is due. Any recorder type. (can run separate on side of the oven as part of the process instruments).

Note

Instrumentation and Instrumentation Calibration refer to AMS2750, sections 3.2, 3.3 and Table 3.

Note: It is recommended that the recorders be used with the rear cover in place when using them for recording data for AMS2750 applications or any thermocouple measurement to minimize the ambient effects on the cold junction compensation measurement.

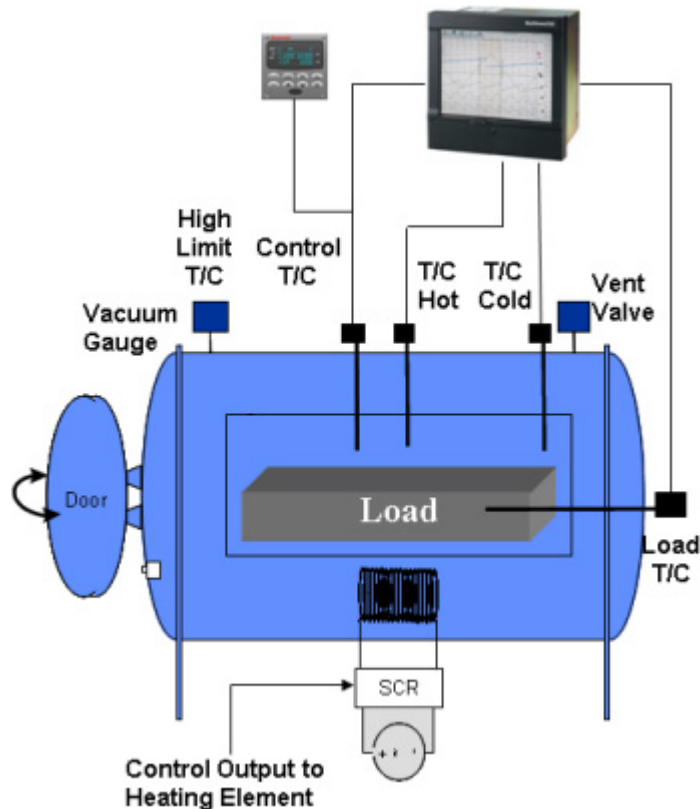

AMS2750 Process mode

AMS2750 process is used when the recorder is attached to the process in the role of a recording device. All **Multitrend GR**, **Minitrend GR**, **eZtrend GR** and **DR Graphic** recorders can operate in the Process mode and can be used as a process recorder to monitor process timers for calibration due dates and thermocouple usage set by the user.

Process mode adds some new status screens and timers to the recorder to help with AMS2750 compliance of the process, giving a countdown to SAT and TUS intervals as well as control TC and instrument calibration. The standard **GR Series** recorders are capable of performing this task by enabling the appropriate number of credits in the Credits Option. This additional functionality provides you with an easier to use more complete solution, especially in conjunction with the thermocouple usage tracking facility, see [“Thermocouple Usage Tracking \(AMS2750\)” on page 390](#).

Note

Abbreviated terms used in this document

- **TUS - Temperature Uniformity Survey**
- **AMS2750 - Aerospace Material Specification**
- **SAT - System Accuracy Test**

The abbreviation will be used throughout this document.

AMS2750 Credit Option

(Main Menu select *Configure > Setup > Edit > General > Factory > Credits > Options*).

AMS2750 Process Mode is available as a credit option, this allows the specification of the AMS2750 modes. To activate credit options, see [“Options” on page 196](#).

AMS2750 Process Mode requires 5 credits to be enabled. If more credits are required please contact **Honeywell**, see back page for contact details.



AMS2750 Process option enables the AMS2750 process mode and thermocouple usage tracking. This option is available for the **Multitrend GR**, **Minitrend GR**, **eZtrend GR** and **DR Graphic** recorders.

Scroll down the menu and select: AMS2750 Process

AMS2750 Process Menu

(Main Menu > Screen > Edit > Screens) or (Main Menu > Configure > Layout > Edit > Screens).

Available on the **Multitrend GR**, **Minitrend GR** **eZtrend GR** and **DR Graphic** recorders.

A dedicated status screen is available for the process mode based on a group, this displays the parameters for the process, furnace details, as well as the countdown timers and thermocouple tracking status.

To enable the process timers select any *Screen#*, go to *Template Type* and select AMS2750 Process.

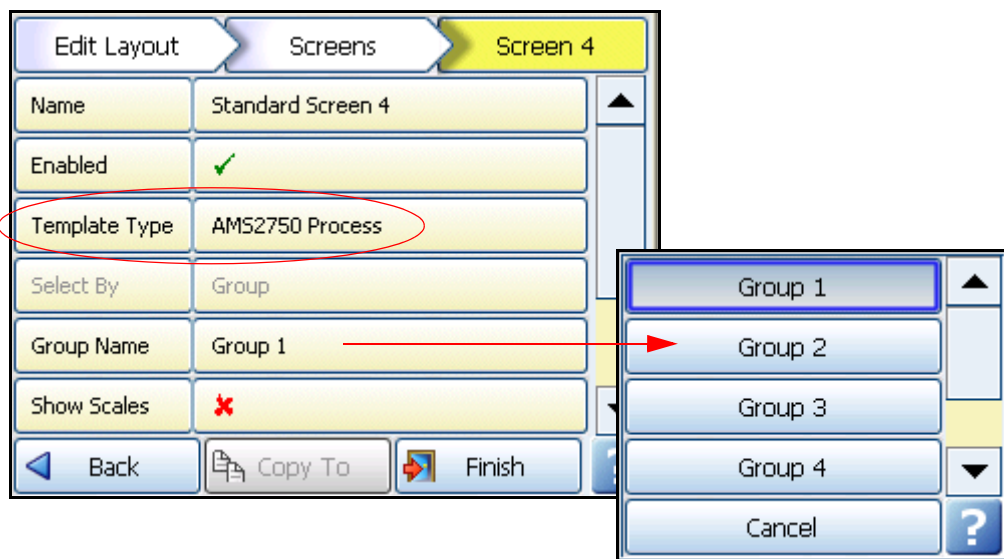

The screen has a group name selection where you can select the groups 1 to 6. This relates to the furnaces 1 to 6 as configured in *"I/O + AMS2750 (Process Mode)" on page 383*, Furnace configuration menu.

NOTE: Pens must be assigned to the individual groups in the Group item in *"Pens Menu" on page 84*.

For details on the complete Screen menu go to *"Screens" on page 157*.

AMS2750 Process Screen

Process Screen details

When the AMS2750 Process screen first appears all the buttons are grey until the due dates are set. Select the button on the screen to set the due dates.

Use the Screen button at the top of the recorder screen to change the screens using the Next and Previous buttons.

AMS2750 Process mode

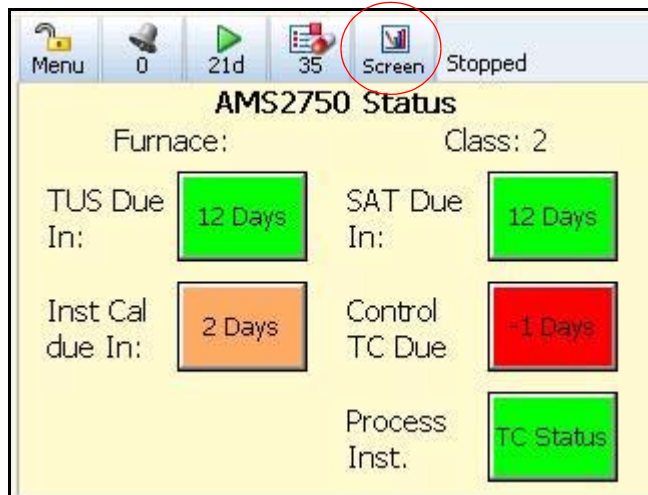

Example of a Process screen on a **Minitrend GR** or **eZtrend GR** recorder.

AMS2750 Process screen. Shows countdown timers that can be set manually by the user.

Green - TC is over 5 days from expiry

Amber - TC's is 0 to 5 days from expiry

Red - TC's has expired.

Select the on screen buttons to set the countdown timers for each timer individually and follow the on screen instructions.

The AMS2750 process screen for the recorder will display the countdown timers for the SAT, TUS, Instrument Calibration and the Control Thermocouple calibration. The number of days remaining are displayed on a colour coded button.

The furnace name and the furnace class is also displayed

AMS2750 Process mode

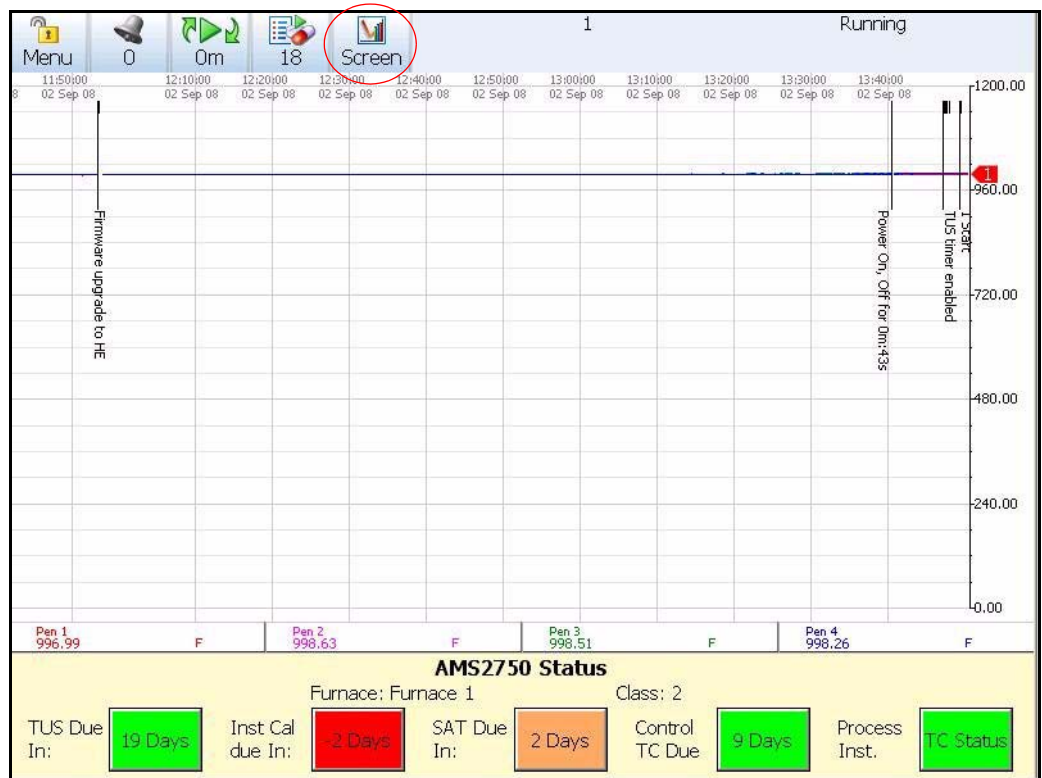

Example of a process screen on an **SX** recorder

Countdown Timers

SAT, TUS, Control TC and Instrument calibration timers

When a SAT, TUS, Instrument Cal or Control TC button is pressed you may be asked to enter user name and password if this function is enabled. [See "Passwords \(AMS2750\)" on page 419.](#)

The timer reset screen is displayed that shows the next suggested date for SAT and TUS depending on Furnace class, material and instrumentation type, or provide a date 1 month in the future for Control TC or Instrument calibration.

The SAT, TUS, Control TC and Instrument Cal timers are separately implemented within a class, where there is one instance per group/furnace (6 in total).

Each timer has a date to expiry, the date is initially set to zero, this indicates that the relevant timer is not required – or has not yet been used.

A timer processing class coordinates the class instances for the thermocouple usage timers and the individual TUS, SAT, Control TC and Instrument Cal Countdown Timers.

The timer can be disabled, by clearing the timer to zero; it will then be shown as unused.

TUS Due In: SAT Due In:

The TUS and SAT countdown timers track the next date for survey/test and displays this information on a the AMS2750 process screen. The user is alerted when these timers are about to expire.

SAT Timer Reset

Please enter the date for the next SAT. The suggested date for Furnace 1 based on its class, instrument type and last SAT date is 09 Oct 2008. Enter the new date to change it and use OK to confirm or Cancel to exit. You may also enable/disable this timer

SAT date

| | | |
|---|-----|------|
| 2 | Oct | 2008 |
|---|-----|------|

| | | |
|---------|---|---|
| Disable | ✓ | ✗ |
|---------|---|---|

When a SAT timer is reset a message is posted to the system message queue. When a SAT timer enters a warning period or expires a message will be posted to the system message list. Upon expiry for SAT or TUS, the recorder displays non-compliance and logs a message to the system message list.

You can reset the date/time for SAT or TUS, providing another new target time/date for the timers. Upon reset a message is logged into the system message list. This is password protected for tracking. See [“Passwords \(AMS2750\)” on page 419](#).

SAT interval timer

The SAT timer is based on tables found in AMS2750 that are dependent on Furnace class, Instrument type and if it is a parts or raw material furnace.

Instrument Cal. Due In:

A countdown timer provides a countdown to the next instrument calibration. This can be changed by selecting this button and changing the date using the on screen date selection. This will reset the next instrument calibration date.

Instrument Cal. Timer Reset

Please enter the date for the next Instrument Cal.. Enter the new date to change it and use OK to confirm or Cancel to exit. You may also enable/disable this timer.

Instrument Cal. date

| | | |
|----|------|------|
| 17 | Sept | 2008 |
|----|------|------|

| | | |
|---------|---|---|
| Disable | ✓ | ✗ |
|---------|---|---|

The user can change the date and select OK, this will reset the timer to countdown to the new date.

The button marked with the “X” will simply return the user to the process screen with the countdown timer unchanged.

The disabled button will set the timer to an “Unused” state by setting the time to 0. The timer will then be displayed as Unused with a grey button. To re-enable the button is pressed and a date entered and ok selected.

Control TC due:

A countdown timer provides a countdown to the next control thermocouple calibration. This can be changed by selecting this button and changing the date using the on screen date selection. This will reset the next control thermocouple calibration date.

Process Inst.:

Displays status of the thermocouple usage tracking, this shows the rolled up status for all TC’s being tracked, the colour of the box determines the state of the TC closest to expiry. If the user presses the TC Status button this goes directly to the TC tracking status screen. [See “Thermocouple Usage” on page 390.](#) Note – this button shows the status for ALL thermocouples being monitored for usage in the system not just for group being displayed.

Timer Reset

When a SAT, TUS, Instrument Cal or Control TC button is pressed you may be asked to enter a user name and password if enabled. [See “Passwords \(AMS2750\)” on page 419.](#)

The dialog box shows the next suggested date for SAT and TUS depending on Furnace class, material and instrumentation type, or provides a date 1 month in the future for Control TC or Instrument calibration.

SAT

System Accuracy Tests (SAT)

AMS2750 Section 3.4 - defines what equipment requires SAT, the frequency, waiver conditions and the test procedure to use

Refer to the section on [“AMS2750 Process mode” on page 378](#) onwards for more details on SAT.

I/O + AMS2750 (Process Mode)

(Main Menu > Configure > Setup > Edit >)

Normally labelled Field IO, this button has been modified for AMS2750 configuration. All other analogue inputs are not affected. This menu includes:

[“Furnace Configuration Menu \(Process Mode\)” on page 385 \(AMS2750 button\)](#)

[“Sensors Configuration Menu \(Process Mode\)” on page 386](#)

AMS2750 Process mode

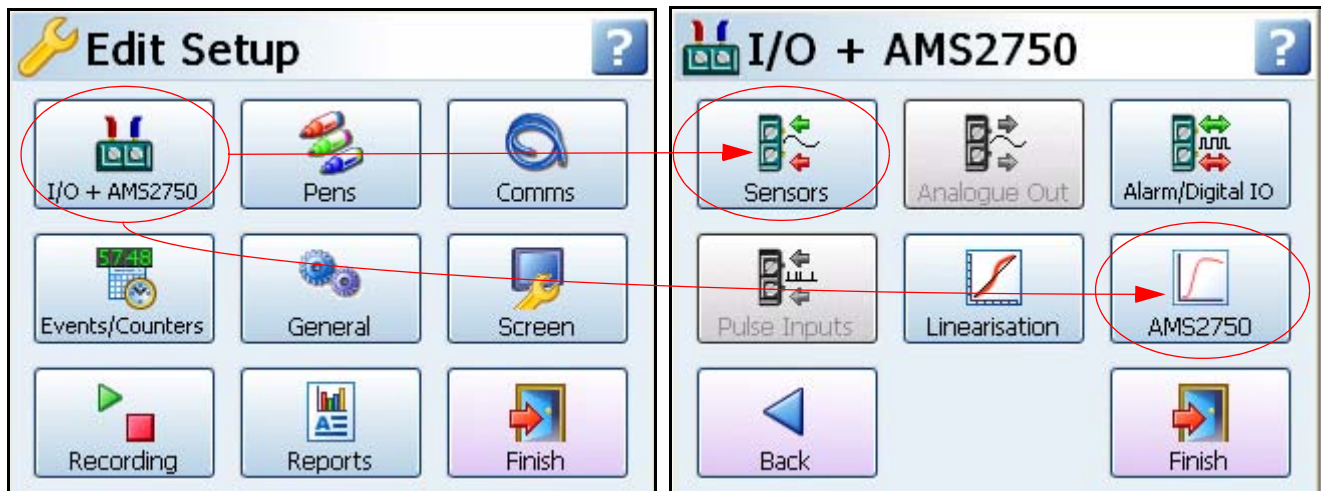

AMS2750 Button (Process Mode)

(Main Menu > Configure > Setup > Edit > I/O + AMS2750)

This button produces the Furnace Configuration Menus

Furnace Configuration Menu (Process Mode)

(Main Menu > Configure > Setup > Edit > I/O + AMS2750)

Refer to AMS2750, section 3.3.1 and Tables 6, 7, 8 & 9.

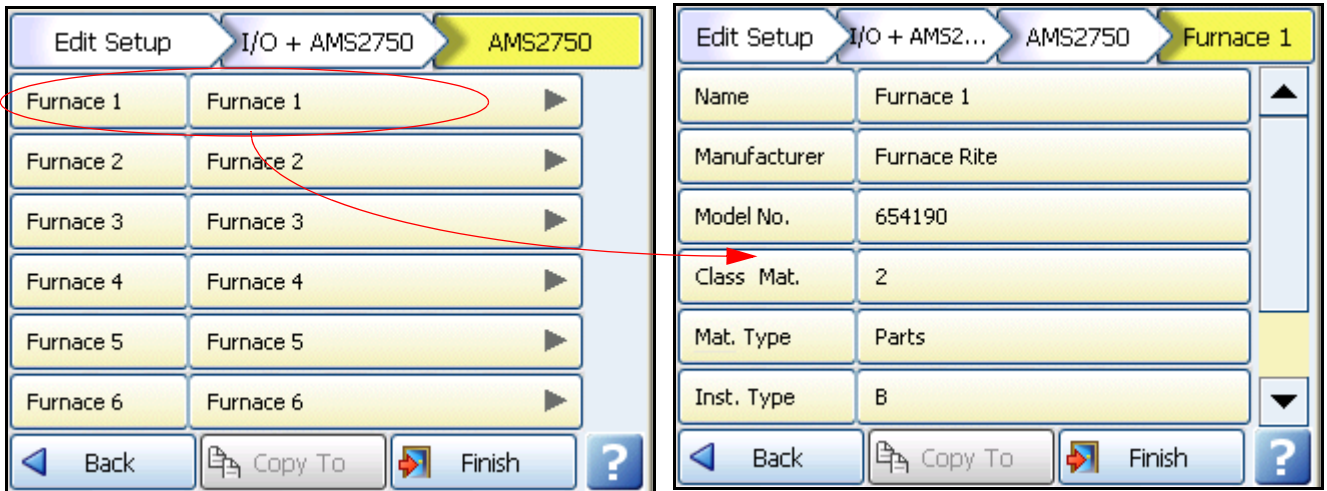

Up to 6 furnaces or ovens can be configured and fed into one recorder. Furnaces 1 to 6 relate directly to Groups 1 to 6 configured in [“AMS2750 Process Menu” on page 379](#). Select each furnace in turn and configure as required.

- **Name** - Name or tag used to identify this furnace. 39 characters of Alphanumeric.
- **Manufacturer** - Enter the manufacturer of the furnace.
- **Model Number** - Unique Model or Serial number of this furnace. 19 characters Alphanumeric
- **Class** - Enter the Furnace class, 1 to 6 numeric
- **Mat. Type** - Enter the type of material or load, Parts or Raw material furnace
- **Instrument Type** - (A to E) Refer to AMS2750, section 3.3.1.1
- **Into cycle at** - used to define a temperature cycle for a certain number of uses. When the furnace has reached the high temperature set here and then falls below the Low temperature set in the menu below, this is a complete temperature cycle.
Eg. Into cycle is set to 110 (can go higher) in use, once it drops back to the Out of cycle set eg. Out of cycle is set to 90, the cycle is complete.
- **Out of cycle at** - Set Out of cycle as explained above in Into Cycle.

When all the furnace details are complete, select Finish and Commit.

Sensors Button

(Main Menu > Configure > Setup > Edit > I/O + AMS2750)

This button produces the Sensor Configuration Menus

Sensors Configuration Menu (Process Mode)

(Main Menu > Configure > Setup > Edit > I/O + Sensors)

Refer to AMS2750, section 3.1 and Table 1, and table 2 for Thermocouple information.

NOTE: As per AMS2750 Standard the Noble metals T/C's (R,S & B) do not require tracking of the number of uses but do require Tracking Calibration, see [page 388](#). The Track Usage will not be available in the menu for these types of T/Cs.

The number of sensors available depends on the hardware fitted in the recorder.

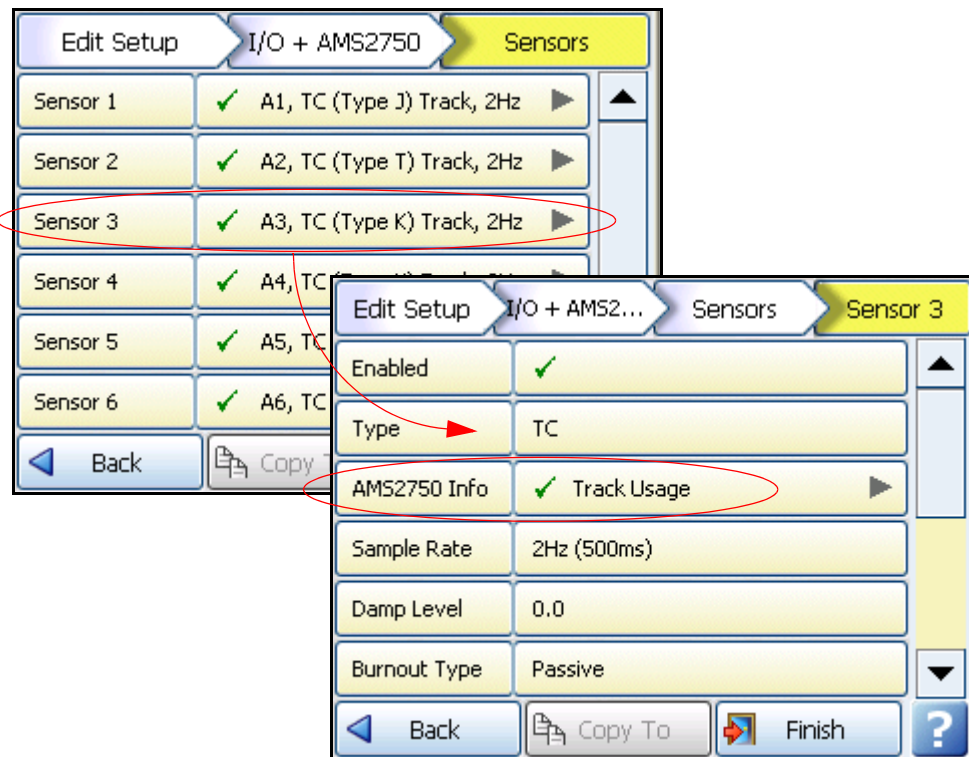

Select a Sensor

- **Enabled** - Toggle On and Off.
- **Type** - Select this for a list of available Signal Inputs.
- **AMS2750 Info** - See [“AMS2750 Info \(Process Mode\)” on page 388](#).
- **Sample Rate** - Select this for a list of available Analogue Input sample speeds. A Fast Scanning range of 50Hz (20ms) is available as a firmware option (not available for the **eZtrend GR** recorder). See [“Firmware Credit System” on page 241](#). Arranged in 2 banks of 3 inputs, and sample rate must be the same within each bank, only for **eZtrend GR** recorder.

AMS2750 Process mode

- **Damp Level** - The damping filter is an advanced algorithm offering improved response over more traditional methods. It works by producing configurable levels of damping - but at the same time being able to respond rapidly to large input changes. Enter the Damp Level in Engineering Units.
- **Burnout Type** - Only available when Type is set to TC (Thermocouple). Toggle between Active and Passive. Active means it will send out a current to the TC. Set to Passive means it takes a reading without sending out a current. The T/C is wired differently for Active and Passive Burnout (see [Figure 2.16 Input signal wiring,](#) on page 31). (Active Burnout is not available for the **eZtrend GR** recorder).
Active Burnout checks the health of the thermocouples every 30 seconds, if your process requires continuous check of the thermocouples to see if they are in burnout you should use Passive Burnout. Active burnout is an implementation of thermocouple health and provides error warning messages for a range of thermocouple activity/failure conditions. Passive burnout does not provide any error warning messages.
If the thermocouple wiring changes and the channel is set to Active, select Passive and Commit the change. Then return to the menu and select Active and Commit the change to update burnout settings.
- **Show Burnout** - Only available when Type is set to TC. Toggle between Upscale and Downscale Burnout.
- **TC Type** - Only available when Type is set to TC. Select this for a list of available TC types.
- **CJ Comp** - Only available when Type is set to TC. Select this for a list of available CJ Compensation. See ["Thermocouple CJC Compensation"](#) on page 338.
 - **Int Automatic** - Uses the cold junction sensor in the recorder as a variable reference temperature
 - **Ext 0 Deg C** - Assumes the cold junction is held at 0° C to provide a 0mV reference, external to the recorder
 - **Ext with Spec Temp** - Uses a reference junction held at a constant temperature. Specify the temperature that the cold junction sensor is to be set at.
 - **Ext Input** - Use a thermocouple or resistance thermometer from another channel to measure the cold junction sensor
- **Units** - (Ohms, Volts and Amps only). This is the Units of Measurement for each input. Select and enter a value. Max 13 characters. For Thermocouple and Resistance Thermometer units, see ["Localisation"](#) on page 136.
- **Label** - Select and enter a identification label for the input. Select and enter a label. Max 15 characters.
- **Sensor Comp** - Sensor Compensation may be required to improve accuracy on a sub range. This is an adjustment to the value of the signal input on each channel, based on the Engineering units settings. Choose from Single Point, Dual Point or Multi Point Cal, see ["Sensor Compensation"](#) on page 351

AMS2750 Info (Process Mode)

(Main Menu > Configure > Setup > Edit > I/O + Sensors > AMS2750 Info)

The items in this menu are different depending on if the recorder is in Process mode or TUS mode. In Process mode this menu is used to track the usage of each sensor (TC). For TUS mode, see [“AMS2750 Info \(TUS Mode\)” on page 399](#).

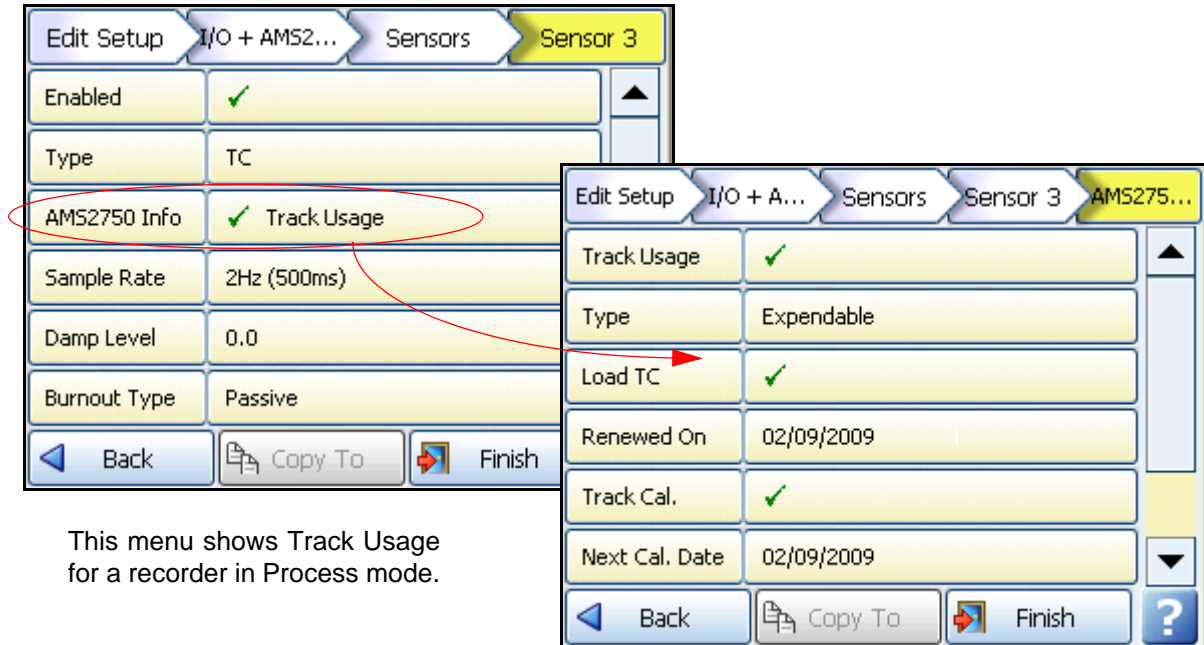

This menu shows Track Usage for a recorder in Process mode.

- **Track Usage** - Check this if you wish to track the usage of this TC.
- **Type** - expendable (Designed for a single use; not reusable), non-expendable thermocouple (Designed for more than one use, refer to AMS2750 spec.). Number of uses, usually 0, this is overridden to allow reuse of salvaged thermocouples, this is clearly logged.
- **Load TC** - Check this if this is the Load TC. TC's attached directly to parts that are being heat treated are usually bare and called load-thermocouples. Only calibrated thermocouple wire be used when making TC's. Refer to AMS2750 spec, Table 1.
- **Renewed On** - Enter a date using the date selection screen for when the sensor was last renewed. i.e. the current TC was connected on this date.
- **Track Cal.** - Check this to track the calibration information of this sensor.
- **Next Cal. Date** - Enter a date using the date selection screen for when the next calibration is due for renewal.
- **Cal. Adjust** - Cal adjust for each TC up to 9 cal points. Extrapolates between those points. Calibration adjustments can be added and deleted, by selecting Add or delete. In the Cal. Point (Deg C) column use the touch screen and the on-screen keypad to enter the calibration point value. In the Correction (Deg C) column enter the amount by which the sensor can be allowed + or - from the Cal point, in degrees C, before being regarded as out of calibration. EG. cal point 1 = 100 (-5), cal point 2 = 300 (1.0), cal point 3 = 500 (-.75). Looks for the setpoint = 150 and works out the sensor cal for 150. [See “Thermocouple Calibration Adjustments” on page 389.](#)
- **Copy Cal. Adjust** - the ability to copy settings from one input to another. See [page 400](#)
- **Cert. No.** - enter the certificate number for the sensor.

Pens for TC's (Process Mode)

Set up and configure pens to display the readings for each thermocouple.

Pens can be allocated to a Group with other pens to display information. Pens are required to be put into a group and then the group # is selected in the Screen menu and displayed on the Process screen. See [“Pens Menu” on page 84](#). To run reports pens must be in a group.

Up to 6 groups of pens can be created. The screen has a group name selection where you can select the groups 1 to 6. See [“AMS2750 Process Menu” on page 379](#).

Groups 1 to 6 relate directly to furnaces 1 to 6 as configured in [“I/O + AMS2750 \(Process Mode\)” on page 383](#), Furnace configuration menu.

Thermocouple Calibration Adjustments

If a thermocouple has been calibrated, the calibration points can be added to the additional TUS info for each sensor, the calibration will then be added to the existing single or dual point cal (Instrument cal)>, under process conditions and the relevant corrections for each soak extracted into the report.

The tables can contain just a single entry, effectively acting as a single point calibration and will be applied across the whole range.

A total of 9 points are available allowing you to specify 1 to 9 calibration points and the sensor correction from that cal point. e.g. cal point 300 deg C, correction = 0.6. This would add a 0.6 degree C correction at 300 degrees C.

| Ins/Del | Cal. Point (Deg C) | Correction (Deg C) |
|---------|--------------------|--------------------|
| 1 | 50.0 | 0.2 |
| 2 | 150.0 | 0.4 |
| 3 | 300.0 | 0.6 |

If only one cal point is entered then it will be taken as a single point cal and that correction applied across the whole range.

If two or more points are added, then a reference table will be generated, this will use the standard reference table functionality currently within **GR Series** and apply that to the signal.

All thermocouple calibration adjustments will be performed after the existing single or dual cal has been applied to the signal.

Thermocouple Usage Tracking (AMS2750)

(Main menu > Status > TC Usage)

Thermocouple Usage Tracking is available with both TUS and Process options.

It provides a means to track the usage of thermocouples within the recorder when being used as a process instrument. This give an indication to when thermocouples need replacing dependent on load cycles and other factors specified in AMS2750.

Thermocouple usage tracking is shown as a status screen within the recorder. It shows the current status of the thermocouple within the furnace in process mode.

A thermocouple has to be configured to be tracked for either calibration or usage within the sensor configuration.

If a thermocouple is set to be tracked but has no expiry or recalibration requirement, the number of days in use will be shown as opposed to a countdown till expiry.

Up to 16 sensor status buttons will be displayed on a **DR Graphic & Minitrend GR**, or **eZ-trend GR** and 24 on an **Multitrend GR**. If more sensors are available than fit on a single page then the "Next" button will be available and will show the remainder of the sensors.

To activate a TC to be tracked, see "[AMS2750 Info \(Process Mode\)](#)" on page 388 or "[AMS2750 Info \(TUS Mode\)](#)" on page 399.

Figure 24.1 Thermocouple Usage

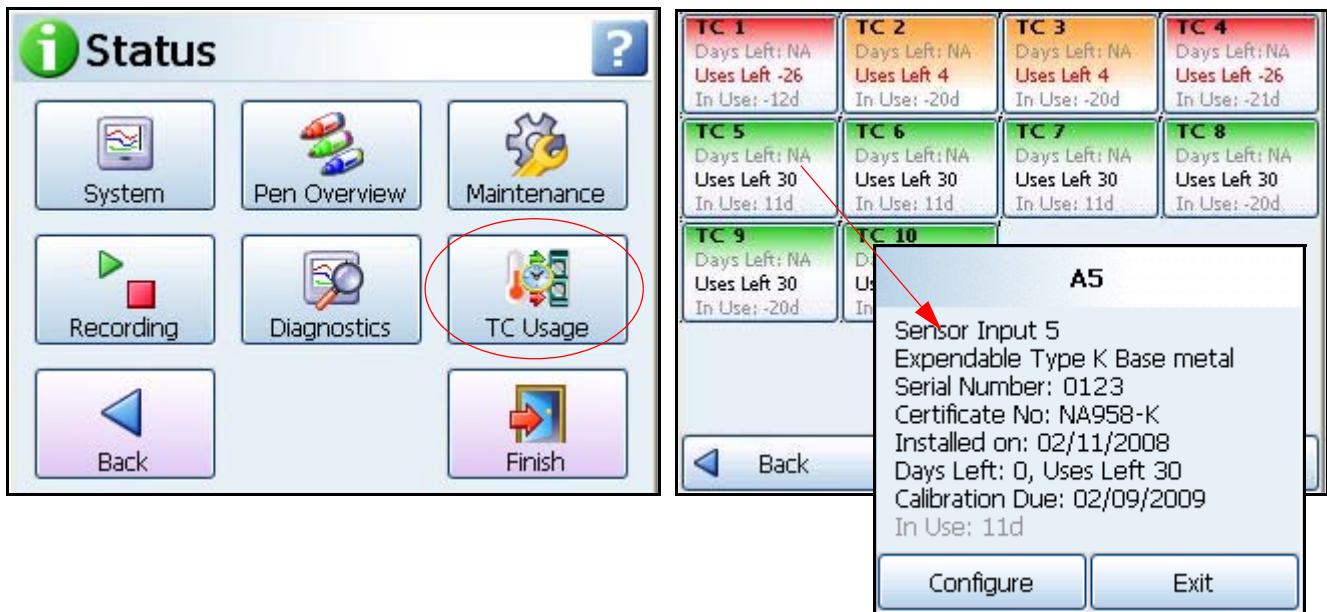

The status for each sensor is shown as a status button, and shows the following top level information.

- Sensor Input/Thermocouple ID
- Overall health – Green = TC is over 5 days from expiry, Amber = TC's is 0 to 5 days from expiry, Red = TC's has expired.
- Countdown in uses/days to end of life - days left, Uses left and how long the TC has been in use.

AMS2750 Process mode

By selecting a sensor a dialog box appears showing more information and also providing a configure button for the sensor. The additional information is as follows and as shown above.

- Type of TC - Expendable or Non-expendable, and metal type
- Serial Number - unique to that TC
- Certificate No. - of sensor
- Installed on - the date when the current TC was connected
- Calibration on - the date when the TC was last calibrated.

Select the Configure button to take a short cut to the Sensors menu (*Main Menu > Configure > Setup > Edit > I/O AMS2750 > Sensors*). You can access the thermocouple and change the details for the newly connected replacement TC. When a thermocouple is reset a message is added to the system message list to indicate a reset.

User alert system to display when a thermocouple is reaching end of life, and when one or more have reached end of life.

The colour coding for the TC Status button on the Process screen are as follows:

- Green - TC is over 5 days from expiry
- Amber - TC's is 0 to 5 days from expiry
- Red - TC's has expired.

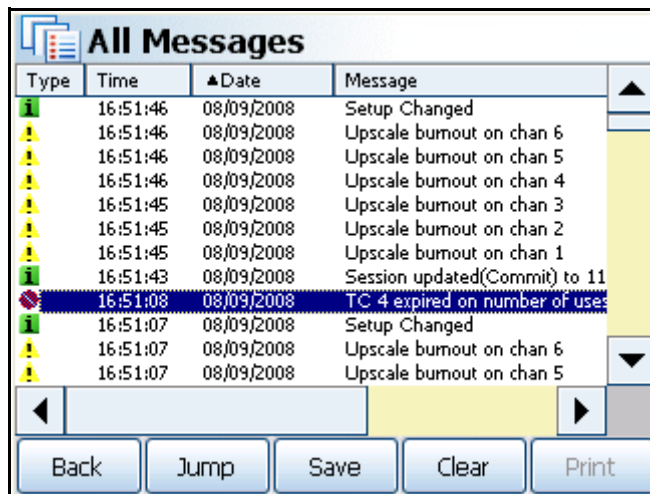

| Type | Time | Date | Message |
|------|----------|------------|--------------------------------|
| i | 16:51:46 | 08/09/2008 | Setup Changed |
| w | 16:51:46 | 08/09/2008 | Upscale burnout on chan 6 |
| w | 16:51:46 | 08/09/2008 | Upscale burnout on chan 5 |
| w | 16:51:46 | 08/09/2008 | Upscale burnout on chan 4 |
| w | 16:51:45 | 08/09/2008 | Upscale burnout on chan 3 |
| w | 16:51:45 | 08/09/2008 | Upscale burnout on chan 2 |
| w | 16:51:45 | 08/09/2008 | Upscale burnout on chan 1 |
| i | 16:51:43 | 08/09/2008 | Session updated(Commit) to 11 |
| r | 16:51:08 | 08/09/2008 | TC 4 expired on number of uses |
| i | 16:51:07 | 08/09/2008 | Setup Changed |
| w | 16:51:07 | 08/09/2008 | Upscale burnout on chan 6 |
| w | 16:51:07 | 08/09/2008 | Upscale burnout on chan 5 |

When the end of life of a thermocouple is reached a message is added to the system message list to indicate a thermocouple has reached end of life, for each thermocouple.

When the recorder is in AMS2750 process mode as an option in the credit menu, you cannot select the "Track Usage" option for B, R or S type Thermocouples.

Per AMS2750 these are considered noble metal thermocouples and should be tracked based on when they require recalibration and not based on uses. The other types of thermocouples can be selected for the "track usage" function but the B, R or S types greyed out and cannot be selected.

TUS mode

Temperature Uniformity Survey (TUS) Mode

The Temperature Uniformity Survey (TUS) is a key requirement for a Nadcap audit. The basic test is to determine how well a furnace performs relative to its design. In particular the uniformity of the temperature within the volume of the working area of the furnace compared to the programmed setpoint.

There are 6 classes of Furnace (Class 1 to 6) based on how well they maintain the temperature within the furnace working area, with class 1 being the tightest and Class 6 the least stringent.

The TUS is performed on a regular basis to insure the furnace continues to meet the uniformity that is defined by the process procedures and the requirements for heat treating a particular part or material. Refer to AMS2750 spec

The TUS also involves the soak time and the amount of temperature overshoot observed (if any).

Another key factor in the heat treatment process is monitoring the number of times the T/C's have been used and the temperatures they have been exposed too to insure they are accurate and reliable.

This type of capability for doing uniformity surveys and documenting the results has been added to the **DR Graphic & Multitrend GR** recorder and provides an easy to use and understand TUS process screen along with a PC analysis software.

Temperature uniformity survey (TUS) mode can be performed using an **DR Graphic & Multitrend GR** recorder that is configured to be used as a TUS test instrument. The **DR Graphic & Multitrend GR** recorder provides a custom display for the user and outputs a custom data set enabling the AMS2750 Report Generation Tool to produce a TUS report. This is a dedicated mode especially for TUS surveys and is only available on the **DR Graphic & Multitrend GR** recorder.

TUS mode on the **DR Graphic & Multitrend GR** recorder is intended to operate as a stand alone piece of test equipment.

A total of 40 sensors can be monitored and the data incorporated into a single report by the **Multitrend GR** recorder. These are consecutive pens from 1 to 40, on a 9 sensors system this assumes the pens are 1 to 9 and map directly to analogue inputs 1 to 9.

The probing method for a TUS survey (AMS2750 3.5.15.1) is supported using MODBUS master within the **DR Graphic & Multitrend GR** recorder performing the TUS, retrieving the additional information via MODBUS from compatible controller/recorder instruments.

TUS mode is selectable using a specific option in the credits system.

AMS2750 (TUS) - Credit Option

(Main Menu select Configure > Setup > Edit > General > Factory > Credits > Options).

AMS2750 TUS Mode is available as a credit option, this allows the specification of the AMS2750 modes. To activate credit options “Options” on page 196.

AMS2750 TUS Mode requires 10 credits to be enabled. If more credits are required please contact **Honeywell**, see back page for contact details.

| Edit Setup | General | Factory | Credits | Options |
|---------------------|---------|---------|---------|---------|
| Counters (3) | ✓ | | | |
| Modbus Master (10) | ✗ | | | |
| Remote View (3) | ✓ | | | |
| Email (3) | ✓ | | | |
| OPC (8) | ✓ | | | |
| Pwd Net Sync (5) | ✗ | | | |
| AMS2750 Process (5) | ✗ | | | |
| AMS2750 TUS (10) | ✓ | | | |
| Extra Pens (3) | 6 | | | |

Back Copy To Finish ?

AMS2750 TUS option enables the recorder to carry out TUS, this also enables the thermocouple usage tracking. TUS is ONLY available on the **DR Graphic & Multitrend GR** recorder, and is not provided on the **Minitrend GR** and **eZtrend GR** models.

Scroll down the menu and select: AMS2750 TUS

AMS2750 Process and AMS2750 TUS options are mutually exclusive.

AMS2750 (TUS) Screen

To enable the AMS2750 TUS screen go from the *Main Menu > Screen > Edit > Screens* (or *Main Menu > Configure > Layout > Edit > Screens*).

The next available screen will default to AMS2750 TUS when this option is selected in the credits. This TUS screen is fixed to that screen number and cannot be changed to another screen type unless the credit option is disabled.

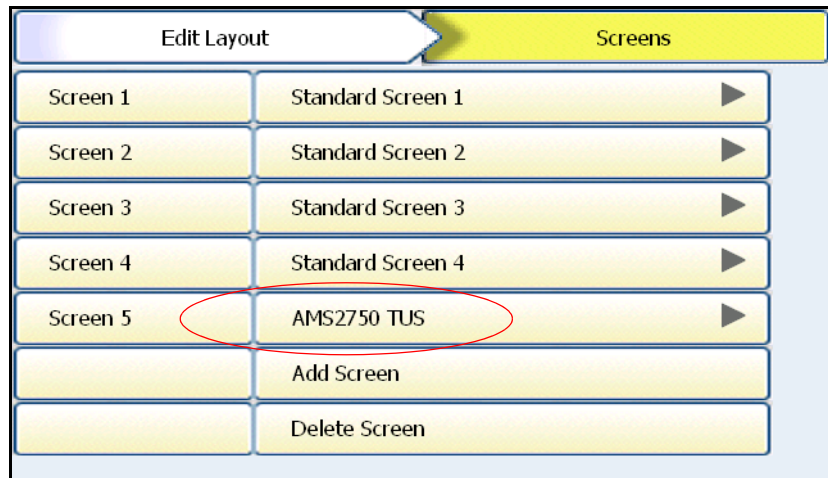

For complete details of the Screen menu go to [“Screens” on page 157](#).

Use the Screen button at the top of the recorder screen to change the screens using the Next and Previous buttons

I/O + AMS2750 (TUS)

(*Main Menu > Configure > Setup > Edit >*)

Normally labelled Field IO, this button has been modified for AMS2750 configuration. All other analogue inputs are not affected. This menu includes:

[“Furnace Configuration Menu \(TUS\)” on page 396 \(AMS2750 button\)](#)

[“Sensor Configuration Menu \(TUS\)” on page 399](#)

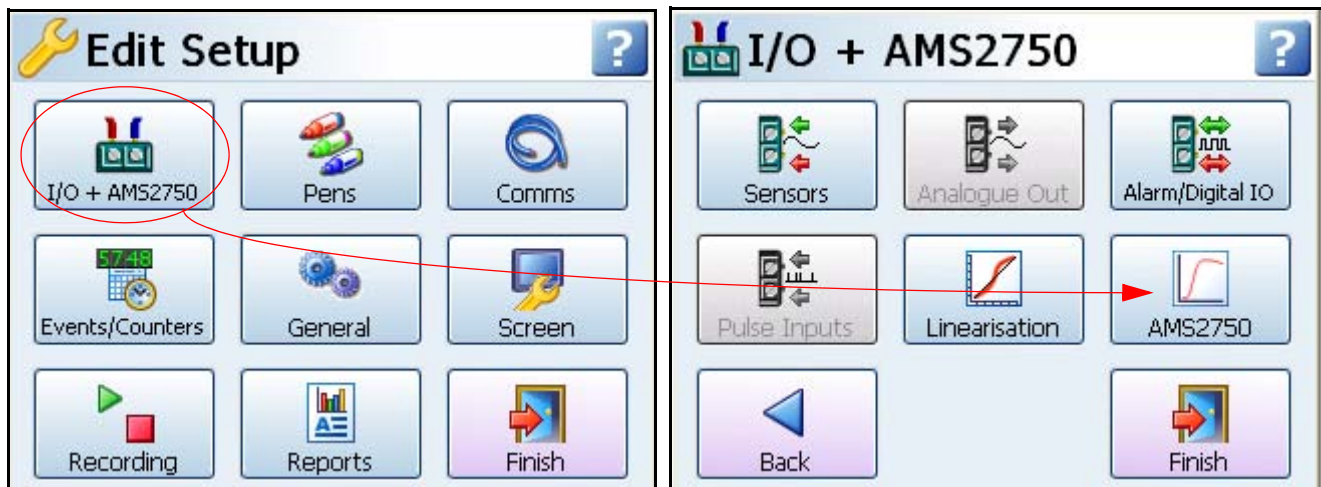

AMS2750 Menu (TUS)

(Main Menu > Configure > Setup > Edit > I/O + AMS2750 >AMS2750)

Each configuration requires TUS specific entries, these are as follows

Ramp and soak configuration, there are up to six ramp and soak settings available, these specify the different soak (dwell) temperatures required for the TUS.

Timers, the timers associated with the TUS soak and ramp detection can be adjusted to suit the user.

The tolerance/hysteresis of the soak stability detection can be adjusted to suite the user, this defines how stability is determined in the soak.

- [“Furnace #” on page 396](#)
- [“Stability Detect” on page 397](#)
- [“Setpoint #” on page 398](#)

| | | | | | | |
|------------------|--------------------|--------------------------|---------|---------|--------|---|
| Edit Setup | | I/O + AMS2750 | | AMS2750 | | |
| Furnace 1 | Grahams Parts Oven | | | ▶ | | |
| Stability Detect | ✓ | Timer Enable/Auto Enable | | ▶ | | |
| Setpoint 1 | ✗ | 150.0 Deg C | | ▶ | | |
| Setpoint 2 | ✗ | 300.0 Deg C | | ▶ | | |
| Setpoint 3 | ✗ | 500.0 Deg C | | ▶ | | |
| Setpoint 4 | ✗ | 750.0 Deg C | | ▶ | | |
| Setpoint 5 | ✗ | 1100.0 Deg C | | ▶ | | |
| Setpoint 6 | ✗ | 1300.0 Deg C | | ▶ | | |
| ◀ | Back | 📄 | Copy To | 🏠 | Finish | ? |

Furnace Configuration Menu (TUS)

(Main Menu > Configure > Setup > Edit > I/O + AMS2750 > AMS2750 >Furnace #)

Refer to AMS2750, section 3.3.1 and Tables 6, 7, 8 & 9.

Furnace #

| | | | |
|--------------|--------------------|----------|-----------|
| Edit Setup | I/O + AMS2750 | AMS2750 | Furnace 1 |
| Name | Grahams Parts Oven | | ▲ |
| Manufacturer | Joe Bloggs | | |
| Model No. | XRH56748 | | |
| Class | 2 | | |
| Mat. Type | Parts | | |
| Shape | Rectangular | | |
| Meas. Units | Metres | | |
| Height | 8.0 Metres | | |
| Width | 5.0 Metres | | ▼ |
| ◀ Back | 📄 Copy To | 🏠 Finish | ? |

A number of parameters are needed for each furnace requiring a TUS, they are stored in a furnace configuration within the setup and are as follows

- **Name** - Name or tag used to identify this furnace. 39 characters of Alphanumeric.
- **Manufacturer** - Enter the manufacturer of the furnace.
- **Model Number** - Unique Model or Serial number of this furnace. 19 characters Alpha-numeric
- **Class** - Enter the Furnace class, 1 to 6 numeric
- **Mat. Type** - Enter the type of material or load, Parts or Raw material furnace
- **Shape** - Furnace shape, rectangular, cylindrical or other
- **Meas. Units** - Furnace measurement units (Metres, millimetres, feet or inches)
- **Height** - Furnace height dependent on shape
- **Width** - Furnace width dependent on shape
- **Depth** - Furnace depth dependent on shape

Note. these are the dimensions for the qualified working area

- **Inst. Type** - Instrument Type (A to E) Refer to AMS2750, section 3.3.1.1

TUS mode

- **Into cycle at** - used to define a temperature cycle for a certain number of uses. When the furnace has reached the high temperature set here and then falls below the Low temperature set in the menu below, this is a complete temperature cycle. Eg. Into cycle is set to 110 (can go higher) in use, once it drops back to the Out of cycle set eg. Out of cycle is set to 90, the cycle is complete.
- **Out of cycle at** - Set Out of cycle as explained above in Into Cycle.

When all the details are complete, select Finish and Commit, or go Back to Stability Detect and setpoint menus.

Stability Detect

(Main Menu > Configure > Setup > Edit > I/O + AMS2750 > AMS2750 > Stability Detect)

During the TUS the recorder starts to monitor all sensors for stability, all sensors must remain stable for a minimum of 2 minutes in order to progress to "in soak, in stability" mode. no TC's can drift by more than "X" degrees within a 2 minute period for stability to be achieved" (X defaults to 0.5 Deg C) *See "During survey" on page 410.*

This time is determined by how you set up the stability parameters whether you base it on time or the degree (temperature) variation

The tolerance/hysteresis of the soak stability detection can be adjusted to suite the user, this defines how stability is determined in the soak.

Stability detect is measured in 3 ways.

1. Timeout, see below
2. Automated detection, see below
3. Manual stability, the user can determine when stability has been achieved and can use the manual override button on the TUS screen to register stability.

| Edit Setup | I/O + AMS2750 | AMS2750 | Stability Detect |
|---------------|---------------|---------|------------------|
| Timer Enable | ✓ | | |
| Time | 10 Mins. | | |
| Auto Enable | ✓ | | |
| Degree Change | 0.5 Deg C | | |

- **Timer Enable** - Default is off. Check this to enable the Stability Detect Timer
- **Time** - (default 10 mins). Timer based stability, the system will be deemed stable after the defined period of time that all TC's remain within tolerance from the point at which they all enter the soak band.
- **Auto Enable** - Default is off. Automatic stability, Stability will deemed to be achieved when all TC's are within tolerance band required for soak for class and no TC continues to change in temperature by more than a user defined degree step between readings.
- **Degree Change** - This becomes enabled when Auto Enable is activated. Default is 0.5 degree over 2 mins, looks for an amount of temperature drift on any TC.

When all the details are complete, select Finish and Commit, or go Back to Furnace or Setpoint menus.

TUS mode

Setpoint

(Main Menu > Configure > Setup > Edit > I/O + AMS2750 > AMS2750 > Setpoint)

The configured setpoint or soak level, this is the level configured for each thermocouple configuration as per AMS2750. Up to 6 setpoints can be configured individually as a part of a single survey. The setpoints must be done in an increasingly progressive order.

| | | | |
|--------------------|---------------|---------|------------|
| Edit Setup | I/O + AMS2750 | AMS2750 | Setpoint 1 |
| Enabled | ✓ | | |
| Setpoint | 150.0 Deg C | | |
| Stable Soak Time | 30 Mins. | | |
| Tolerance Override | ✓ | | |
| Tolerance | 2.0 Deg C | | |

- **Enabled** - Default is off. Check to enable.
- **Setpoint** - Enter the survey setpoint value as a temperature.
- **Stable Soak Time** - soak time for the actual survey period. Per AMS2750, the minimum survey soak time is 30 minutes.
- **Tolerance Override** - Check to enable. This will become the working tolerance for the soak in the TUS as opposed to the tolerance for the class.
- **Tolerance** - set a tolerance override temp value.

When all the details are complete, select Finish and Commit, or go Back to the Furnace or Stability Detect menus.

Sensor Configuration Menu (TUS)

(Main Menu > Configure > Setup > Edit > I/O + AMS2750 > Sensors)

Refer to AMS2750, section 3.1 and Table 1, and Table 2 for Thermocouple information.

The number of sensors available depends on the hardware fitted in the recorder.

The menu configuration is the same as “Sensors Configuration Menu (Process Mode)” on page 386

Sensor #

(Main Menu > Configure > Setup > Edit > I/O + AMS2750 > Sensors > Sensor #)

The menu configuration is the same as “Sensors Configuration Menu (Process Mode)” on page 386 except for the AMS2750 Info menu.

AMS2750 Info (TUS Mode)

(Main Menu > Configure > Setup > Edit > I/O + AMS2750 > Sensors > Sensor # > AMS2750 Info)

In TUS mode (DR Graphic & Multitrend GR recorders only) each sensor requires additional information, this information is stored separately to the recorder configuration allowing it to be reused for multiple furnaces (or recorder configurations)

| | | | | | | | | | |
|--------------|--|----------------|--|---------|--|----------|--|--------------|--|
| Edit Setup | | I/O + AMS2... | | Sensors | | Sensor 1 | | AMS2750 Info | |
| TUS TC | | ✓ | | | | | | | |
| Control TC | | ✗ | | | | | | | |
| Track Usage | | ✓ | | | | | | | |
| Serial No. | | 123456 | | | | | | | |
| Position | | top left front | | | | | | | |
| Manufacturer | | Furnace Rite | | | | | | | |
| Type | | Expendable | | | | | | | |
| Renewed On | | 01/09/2009 | | | | | | | |
| Track Cal. | | ✓ | | | | | | | |
| Back | | Copy To | | Finish | | ? | | | |

TUS mode

- **TUS TC** - Check this to include this TC in the TUS
- **Control TC** - Depending on Instrument type refer to AMS2750 specification, section 3.3. If a TC is set to be “control TC” i.e. the input is spliced into the control TC, all functions will remain the same as for all other survey TC’s, except there will be no calibration adjustments for the Control TC.
- **Track Usage** - Check this if you wish to track the usage of this TC.
- **Serial Number** - Batch or Serial number of this sensor, 40 Alphanumeric.
- **Position** - of thermocouple, enter the position of the sensor in the furnace. Eg. Top left front or Bottom right back.
- **Manufacturer** - Enter the manufacturer of the sensor, 20 alphanumeric
- **Type** - expendable, non-expendable thermocouple. Number of uses, usually 0, this is overridden to allow reuse of salvaged thermocouples, this is clearly logged.
- **Renewed On** - Enter a date using the date selection screen for when the sensor was last renewed. i.e. the current TC was connected on this date.
- **Track Cal.** - Check this to track the calibration information of this sensor.
- **Next Cal. Date** - Enter a date using the date selection screen for when the next calibration is due for renewal.
- **Cal. Adjust** - Cal adjust for each TC up to 9 cal points. Extrapolates between those points. Calibration adjustments can be added and deleted, by selecting Add. In the Cal. Point (Deg C) column use the touch screen and the on-screen keypad to enter the calibration point value. In the Correction (Deg C) column enter the amount by which the sensor can be allowed + or - from the Cal point, in degrees C, before being regarded as out of calibration. EG. cal point 1 = 100 (-5), cal point 2 = 300 (1.0), cal point 3 = 500 (-.75). Looks for the setpoint = 150 and works out the sensor cal for 150. *See “Thermocouple Calibration Adjustments” on page 389.*
 - **Copy Cal. Adjust** - the ability to copy settings from one input to another with copy capability up to 12 TC survey with 9 TC Cal. Configure one channel completely including the adjust factors then select “Copy Cal Adjust” at the bottom of the screen..

| | | | |
|----------------|------------------|----------|---|
| Next Cal. Date | 02/11/2010 | ▼ | |
| Cal. Adjust | 0 Points | | |
| Cert. No. | | | |
| ◀ Back | Copy Cal. Adjust | ▶ Finish | ? |

When the “Copy Cal. Adjust” is pressed a multi selection screen is displayed which allows the choice of multiple channels to copy to. A channel is selected by touching the corresponding channel number, and when completed the user applies the changes by touching the tick, the finish & commit as usual.

Note that the source channel will always be blocked by a “no entry” sign as it is not possible to copy a channel to itself, as shown below. In this example channel one is being copied to channels 2 through 10.

This capability is available in both AMS2750 survey and process modes, and what is copied is listed below

TUS mode

Select Channels to Copy to:

| | | | | | | | | | |
|----|----|----|----|----|----|----|----|----|----|
| | 2 | 3 | 4 | 5 | 6 | 7 | 8 | 9 | 10 |
| 11 | 12 | 13 | 14 | 15 | 16 | 17 | 18 | 19 | 20 |
| 21 | 22 | 23 | 24 | 25 | 26 | 27 | 28 | 29 | 30 |
| 31 | 32 | 33 | 34 | 35 | 36 | 37 | 38 | 39 | 40 |
| 41 | 42 | 43 | 44 | 45 | 46 | 47 | 48 | | |

Clear
✓
✗

Each channel has a number of pieces of information that are used by the instrument and the generated survey report. The copy function does not just copy the Cal. Adjust-ment table, the following other items are copied

Table 24.1 :

| TUS Mode | Process Mode |
|---------------------------|---------------------------|
| Track usage flag | Track usage flag |
| Serial number | |
| Manufacturer | |
| Type | Type |
| Renewed On date | Renewed On date |
| Track Cal flag | Track Cal flag |
| Next Cal date | Next Cal date |
| Cal. Adjust table in full | Cal. Adjust table in full |
| Certificate number | Certificate number |

- **Cert. No.** - enter the certificate number for the sensor, 20 alphanumeric

Any sensor correction factor is deemed to be a single point cal, configured within the Analogue input configuration menu.

Note: All above information is copied from the source channel as is, and the user would need to go to each designation channel and adjust the specific information that would be different for the designation channels.

Pens for TC's (TUS Mode)

This is not available in TUS mode, available in Process mode only.

TUS survey process screen

A survey status screen is available as a standard process screen in the DR Graphic & SX recorder. it is available at all times and the screen cannot be deleted. See “AMS2750 (TUS) Screen” on page 394.

This screen is only available when TUS is selected in the credit system. See “AMS2750 (TUS) - Credit Option” on page 393.

The survey status screen displays information about the TUS and provides on-screen buttons to control the survey, Start/Stop TUS, Configure TUS and Export TUS.

Top panel - shows a summary of the survey details plus TUS operation buttons

The screenshot shows the 'Temperature Uniformity Survey (Stopped)' screen. The top panel includes a navigation bar with 'Menu', '0', '7d', '19', and 'Screen' icons, along with the title 'AMS2750 TUS' and the date/time '25 Sep 08 15:38:14'. Below this, furnace details are listed: Name: Parts Oven, Model No: XRH56748, Instrument Type: B, Username: NA, No. of TC's: 65535, Class: 2, Time Started: NA, Elapsed: NA, Condition: Stopped. Three buttons are visible: 'Start TUS', 'Configure TUS', and 'Export TUS'. The middle panel is a table with columns: Setpoint (Tol.), Status, Max TC, Min TC, Max TC Diff, Max TC/SP Diff, Max Ramp Overshoot, Ramp duration, TC Lag into Soak, Stable Soak Duration, Meets Class, and TC's Stabilized Manual Override. The table has 6 rows, with the first three rows containing data and the last three rows containing 'NA'. The 'TC's Stabilized Manual Override' column contains buttons: 'TC's Stabilized', 'Remove TC's', and 'Restart Soak'. The lower panel shows a timeline from 4:55:00 to 15:35:00 on 25 Sep 08. On the right, there are three digital readouts: 'Max TC Max TC 0.0 C', 'Min TC Min TC 0.0 C', and 'TC Diff 0.00 C'. A red arrow points from the text 'Top panel - shows a summary of the survey details plus TUS operation buttons' to the 'Start TUS' button. Another text box points to the 'TC's Stabilized Manual Override' section, stating 'Middle panel displays the setpoint information plus manual stability override button'. A third text box points to the digital readouts, stating 'Lower panel displays two thermocouples, Max and Min temperatures plus a third reading of the difference between them'.

- See “Top Panel” on page 403.
- See “TUS Survey Process screen - Middle panel” on page 406.
- See “TUS Survey Process screen - Lower panel” on page 408.

Top Panel

The top panel shows a summary of the survey including the furnace details and TUS control buttons. All information displayed here has been entered in the [See “AMS2750 Menu \(TUS\)” on page 395.](#)

Other information displayed includes: The start time is entered into the “started” field in the top panel and the elapsed timer shows how much time has passed since the survey was started, this will be updated within a 2 second period. The Condition field will display the status of running.

The Start/Stop button

This displays the configuration confirmation wizard, if accepted it starts the TUS running, see [“Configure Confirmation Wizard” on page 403.](#) This is only available when a TUS is not running and can be password protected. See [“Passwords \(AMS2750\)” on page 419.](#)

The Stop button is available when a TUS is running, it prompts the user for confirmation to stop the current TUS, this button is password protected.

When the TUS is started an event is triggered and a message is logged into the system events.

The Configure TUS button

The configure TUS button allows you to quickly check and modify the relevant TUS information before starting a TUS, this will not start the survey. It displays the TUS Configuration Confirmation wizard of which there are two screens. It is only available when a TUS is not running and is password protected.

The Export TUS button

The export button allows you to export the most recently completed TUS data file, and will prompt for a USB key, external SD card or Network Share folder (NAS) as follows. The .tus file can be loaded into a PC to be read by the AMS2750 Report Generation Tool which generates a full report.

Configure Confirmation Wizard

The “Start” and “Configure” buttons display the configuration confirmation wizard which displays the currently configured details and consists of two configuration screens.

- **Screen 1** of the wizard shows the furnace and temperature profile (ramps & soaks) details, allowing the user to edit the configuration or load a saved configuration. You can accept the details and progress or cancel out of the wizard at this point
- **Screen 2** of the wizard shows the sensor configuration, specifically the sensor ID, position and status. Changes can be made here to the sensor configuration, you can at this stage proceed or cancel the wizard.

You are prompted for additional notes as a free format text when starting a TUS.

This will display the currently configure furnace details and the target soak information for the TUS, the user has 4 options on this page.

TUS mode

TUS Configuration Confirmation

| | | |
|--------------|----------------|---|
| Name | Furnace 1 | ▲ |
| Manufacturer | XYZ Furnace Co | □ |
| Model No. | QW-234-Y-45 | □ |
| Class | 2 | ■ |
| Type | Parts | ■ |
| Shape | Rectangular | ▼ |
| Height | 5.00 Feet | |

| Name | Soak | Time |
|------------|---------------|----------|
| Setpoint 1 | 400.00 Deg F | 30 Mins. |
| Setpoint 2 | 600.00 Deg F | 30 Mins. |
| Setpoint 3 | 1000.00 Deg F | 30 Mins. |

Load Config Edit Config Cancel Next >

TUS Configuration - Screen 1

- **Load Config** - Configurations can be loaded via external media into the recorder manually, this will allow you to load in a new configuration to perform another furnace survey.
- **Edit Config** - will take you directly into a setup edit and into the AMS2750 configuration page to edit furnace and soak details, you can modify the details as required. Once completed you will be returned to the wizard page showing the newly loaded configuration details. Note – if a configuration is changed so that it requires system restart then you will not be returned to the same place in the wizard and any parked configurations will be over written.
- **Cancel** - will take you back to the TUS screen, but this will not cancel any changes made in the load or edit config options.
- **Next** - will move you onto the second page of the configuration confirmation wizard, this will provide an overview of the currently attached sensors included in the TUS and their status, the screen is as follows

Screen 2 shows the following information on the thermocouples

- **TC Number** – the number relating to the analogue input for the thermocouple.
- **Position** – The text position of the sensor within the furnace.
- **Status** – the current status of the sensor with relation to the thermocouple tracking. The status will display “good” for a thermocouple whose usage or calibration is ok and not within an expiry period. “Warning” for a thermocouple whose status is OK but a calibration or usage is due to expire shortly, or “expired” for a thermocouple that has expired on either usage or calibration.

TUS mode

If a thermocouple is included in the TUS but has been set not to be tracked the status will be shown as “good”.

| | TC | Position | Status |
|---|----|--------------------|---------|
| ● | 1 | Front Bottom Right | Good |
| ● | 2 | Front Bottom Left | Good |
| ● | 3 | Front Top Right | Warning |
| ● | 4 | Front Top Left | Expired |
| ● | 5 | Back Bottom Right | Good |
| ● | 6 | Back Bottom Left | Good |
| ● | 7 | Back Top Right | Good |
| ● | 8 | Back Top Left | Good |
| ● | 9 | Middle | Good |

Change Sensors Cancel Done

TUS Configuration - Screen 2

A coloured icon will be listed on the line of the TC as a visual aid to identify issues quickly. The colours will be defined as Green for good, Amber for warning and Red for expired.

- **Change Sensors button** - will take you directly to the sensor status page for thermocouple usage, This helps to identify the exact issue relating to a thermocouple and take the appropriate action as described in the section TC Usage status screen, see [“Thermocouple Usage Tracking \(AMS2750\)” on page 390](#).
If none of the thermocouples have been configured to be included in the usage tracking then the “Change Sensors” button will be greyed out.
- **The Cancel button** - will simply cancel the dialog and return to the process screen, but this will not cancel any changes made in “change sensors” option.
- **The Done button** - will prompt the “Start a TUS now” dialog to be displayed. Select No, to return to the process screen, or selects Yes to start TUS. The next screen to be displayed will be the start TUS note entry screen, see [“Start a Survey” on page 410](#).

TUS mode

TUS Survey Process screen - Middle panel

Middle section lists up to 6 setpoints that have been entered for the survey. This section shows the currently configured soak levels.

If you only have 2 setpoints eg. 600 and 950, this would give a temperature difference of 300. Check AMS2750 spec to see if a temperature difference of 300 is allowable, if not an additional setpoint may need to be added.

Each setpoint in the list has a tolerance width band (see table in spec)

Status shows what stage of the survey is running.

There are four stages of the survey: Detect, Soak (unstable), Stable soak and Done. These are shown in more detail in [“During survey” on page 410](#).

| Furnace | | Username: NA | | Time | | Stop TUS | | Configure TUS | | Export TUS | |
|-----------------------|--------|----------------|-------------|------------------------------|----------------|--------------------|---------------|------------------|----------------------|-------------|--|
| Name: Furnace 1 | | No. of TC's: 8 | | Started: Fri Aug 29 15:21:07 | | | | | | | |
| Model No: QW-234-Y-45 | | Class: 2 | | Elapsed: 1h:25m:53s | | | | | | | |
| Instrument Type: B | | | | Condition: Running | | | | | | | |
| Setpoint (Tol.) | Status | Max TC | Min TC | Max TC Diff | Max TC/SP Diff | Max Ramp Overshoot | Ramp duration | TC Lag into Soak | Stable Soak Duration | Meets Class | TC's Stabilized Manual Override <input type="button" value="TC's Stabilized"/> <input type="button" value="Remove TC's"/> <input type="button" value="Restart Soak"/> |
| 1 400.00F (+/-10.0) | Done | TC2 405.09F | TC1 402.66F | TC2 - TC1 2.43F | TC2 5.09F | TC7 405.29F | 2m:35s | 1s | 30 Mins. | 2 | |
| 2 600.00F (+/-10.0) | Done | TC2 600.72F | TC1 598.18F | TC2 - TC1 2.54F | TC1 1.82F | TC2 600.72F | 4m:46s | 22s | 30 Mins. | 1 | |
| 3 1000.00F (+/-10.0) | Detect | TC0 0.00F | TC0 0.00F | TC0 - TC0 0.00F | TC0 0.00F | TC0 0.00F | 10s | | 0 Mins. | -- | |
| 4 NA | | | | | | | | | | | |
| 5 NA | | | | | | | | | | | |
| 6 NA | | | | | | | | | | | |

- **Detect** (blue) is when the TC's are coming up to temperature, including any under or overshoot, and begins to level out around the setpoint.
- **Soak unstable** (magenta) begins when the first TC's are within the tolerance band and begin levelling out around the setpoint. As soon as the first TC goes into soak the setpoint turns magenta.
- **Stable soak** (yellow) is a minimum 30 minute test period of the stable TC's. Check spec for stable soak time as it depends on size of oven and load and some ovens require longer stable soak duration. It enters this stage based on the Stability criteria that was set up during the AMS2750 setup.
- **Done** – (Red or Green) the setpoint survey step has completed (minimum of 30 minutes) and recorder indicates whether that survey setpoint was successful or not.

Other colour codes are Green when the survey is complete, grey when the TUS has been stopped and not complete and Red when a TC has failed.

- **First column** - Number of the thermocouple
- **Setpoint (Tol.)** - The configured setpoint or soak level, this is the level configured for each soak within the AMS2750 setup configuration.
- **Status** - This shows the current status of the soak, and can be one of the following
 - **Blank** - A soak for the setpoint has not been started yet.

TUS mode

- **Detect** - The first stage starts when the temperature is ramping up towards the setpoint.
- **Soak** – All TC's have entered the soak level and are in tolerance, but not yet stable.
- **Stable** – All TC's within soak and stability for less than 30 minutes, if over 30 minutes will show "Done".
- **Done** – A soak has been completed where all TC's have remained within tolerance for at least 30 minutes after stability.
- **Failed** – Indicates that stability was achieved for a setpoint but did not remain within the required limits for at least 30 minutes.
- **Max. TC** - Shows the maximum temperature reached for a soak period whilst in stability and the TC that made the measurement.
- **Min. TC** - Shows the minimum temperature reached for a soak period whilst in stability and the TC that made the measurement. In the case where more than one TC is at the same level the first TC to reach this level is displayed and recorded.
- **Max. TC Diff.** - Shows the largest difference between the Maximum and Minimum TC's. In the case where more than one TC is at the same level the first TC to reach this level is displayed and recorded.
- **Max. TC/SP Diff.** - Shows the largest difference between the measured temperature and the setpoint and which TC made the measurement. In the case where more than one TC is at the same level the first TC to reach this level is displayed and recorded.
- **Max. Ramp Overshoot** - This will monitor the maximum overshoot entering soak before stability is achieved and which TC made the measurement. In the case where more than one TC is at the same level the first TC to reach this level is displayed and recorded.
- **Ramp Deviation** - The total time taken for all TC's to enter the soak from the previous setpoint or start of survey. It shows the first TC to get within the temperature tolerance eg +/- 6. This reading stops when all the TC's are within the tolerance of the setpoint.
- **T/C lag into Soak** - Shows the time difference between the first TC and the last TC comes into the tolerance band (hottest and the coldest). Lag is the time difference between the first and last TC's entering the setpoint tolerance band.
- **Stable Soak Duration** - Measures the length of time all the TC's are with in the tolerance band of the setpoint. When in stable soak show the Max TC and Min TC readings for the entire run period. TC1-10 Diff (difference) and TC/SP Diff are also displayed.
- **Meets Class** - On a successful soak period, the actual class met by the soak is shown.

The survey auto detects the next TC to test when last one has either completed or failed (out of band width) and will carry on testing the others.

The "TC's Stabilized" button

This button will only be enabled (available) when a soak has all TC's within the soak and acceptable tolerance, pressing the button will override the stability detection and put the current soak from "soak" mode to "stable" mode.

TUS mode

TUS Survey Process screen - Lower panel

The graph will display the current state of the highest and lowest temperature sensors, as the TUS is not running this will simply show the full scale i.e. not zoomed in to any specific soak.

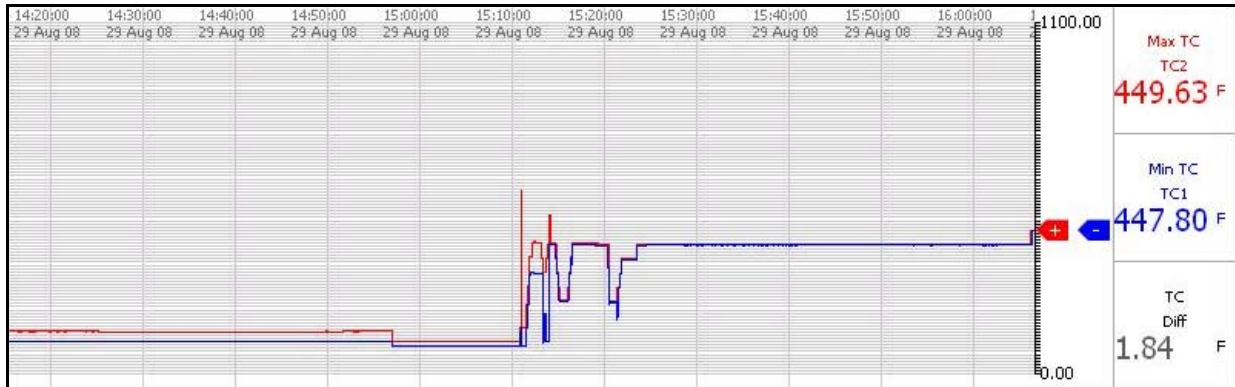

The pens on the graph area show two thermocouples, one minimum temp and one maximum temp. When the TC's reach the soak period the chart reconfigures and zooms in on the setpoint area contained inside the tolerance width band. The lower panel displays digital readings of the two TC's, Max and Min (hottest and coldest), and a third pen displays a digital reading of the difference in temperature between the two TC's.

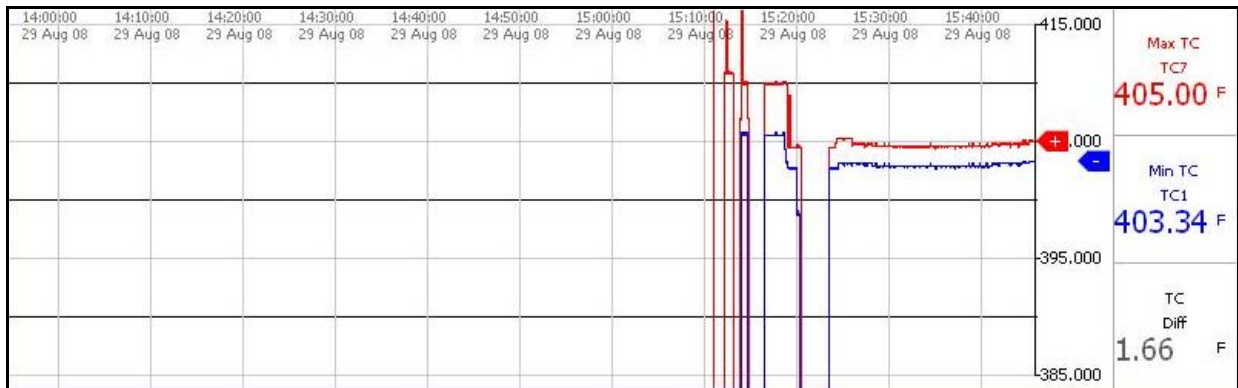

It also will automatically "Zoom-in" when the temperature reaches the lower limit as defined by the AMS2750 specification for the defined Furnace Class. So for example, if the furnace being surveyed is defined to be a Class 2 furnace and you are doing a survey SP at 600°F, the trend graph will switch from a full scale graph (say 0 to 1100°F) to a Zoomed in scale that shows the configured SP \pm the Furnace class limit.

TUS mode

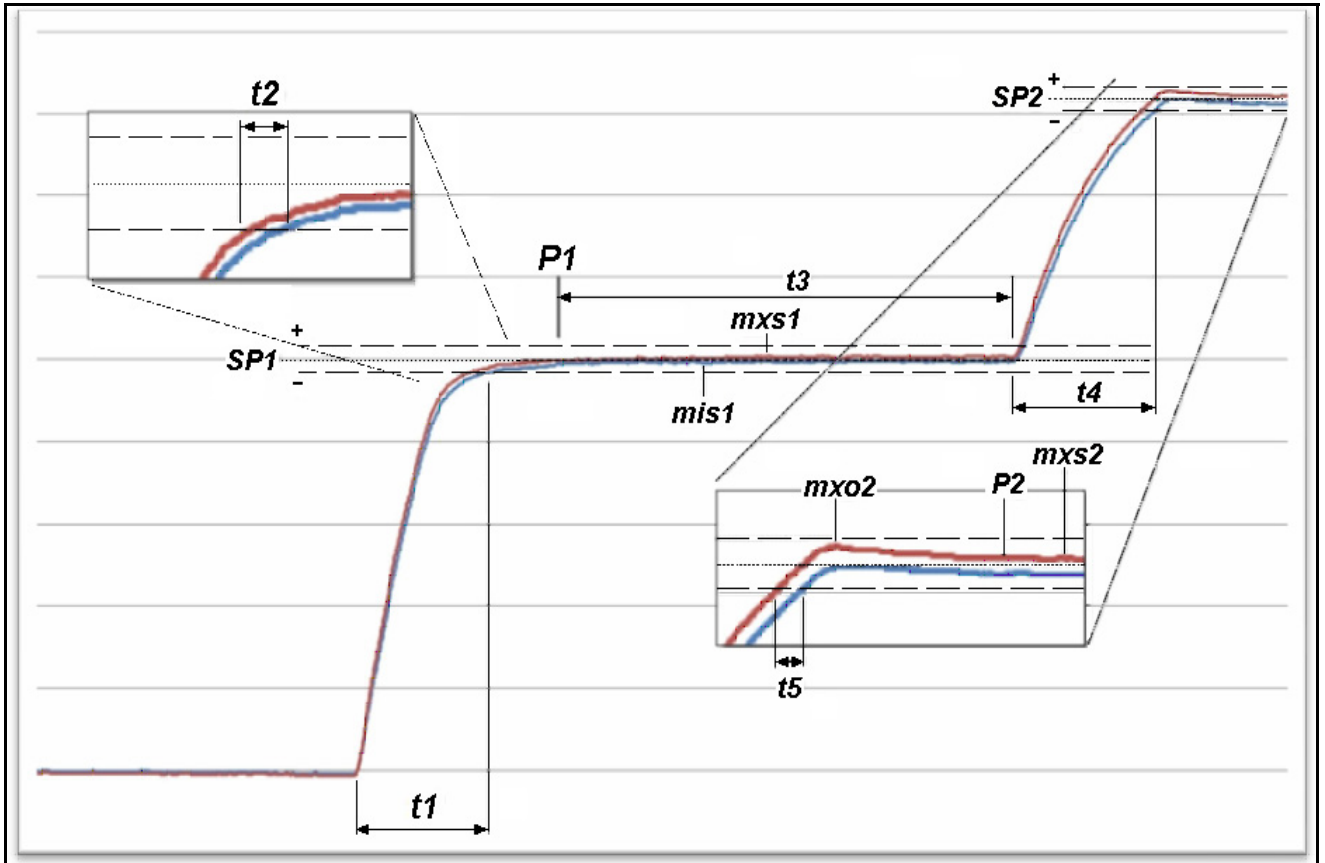

- SP1 = setpoint 1 and SP2 = setpoint 2.
- Time t1 = the ramp time for the first ramp
- Time t2 = time between first TC entering Dwell zone and Last TC entering Dwell Zone for setpoint 1 (SP1)
- Point P1 = The point where all TC's are stable and lie within the SP1 Tolerance limits. Timer t3 starts at this point
- Time t3 = the dwell time SP1. Must be at least 30 minutes within SP1 tolerance limits
- Value mxs1 = Maximum temperature value during the SP1 dwell period.
- Value mis1 = Minimum temperature value during the SP1 dwell period.
- Time t4 = the ramp time for the second ramp
- Time t5 = time between first TC entering Dwell zone and Last TC entering Dwell Zone for setpoint 2 (SP2)
- Value mxo2 = Maximum temperature overshoot recorded prior to P2. The value for mxo1 in this example would be the value of the TC at P1 as there is no measured "overshoot".
- Point P2 = The point where all TC's are stable and lie within the SP2 Tolerance limits.
- Value mxs2 = Maximum temperature value during the SP2 dwell period.

Start a Survey

The start TUS button will produce the configuration confirmation wizard, see [“Configure Confirmation Wizard” on page 403](#)

At the end of the wizard the Start TUS dialog appears. This allows you to enter 150 characters of free format notes using the SIP or a keyboard if attached, which is included in the TUS data file and the report generated by the AMS2750 Report Generation Tool.

You can select cancel to return to the process screen, but any notes that were entered will be lost.

When a TUS is running you will not be allowed to enter configuration i.e. when a survey is running you cannot enter setup. The user will have to complete or abort the TUS to enter configuration mode.

You can press the start button, this will return to the process screen and start the TUS monitoring.

When the TUS is started an event will be triggered identifying this and a message will be logged into the system events.

Warning messages may appear if a previous TUS file has not been exported. Only one TUS file is saved in the memory.

Events can be set up to Start or Stop a TUS. See [“Events \(AMS2750\)” on page 416](#).

During survey

Once a survey has been started the TUS process screen will be set to the Running condition.

Each soak is allocated a separate status line, with all soaks being shown in this fixed format.

The system will detect when all relevant TC's are within the acceptable soak limits and will populate the information in the line of the relevant soak.

The “TC's Stabilized” button will only be enabled (available) when a soak has all TC's within the soak and acceptable tolerance, pressing the button will override the stability detection and put the current soak from “soak” mode to “stable” mode.

The “Configure TUS” and “Export TUS” button will be disabled whilst a TUS is running.

Survey status

Once a TUS is started the recorder moves between three operating modes, this helps automate the process and provide feedback as to how the survey is performing.

1. See [“Detect” mode” on page 411](#).
2. See [“Soak” mode” on page 412](#).
3. See [“Stable \(in soak\)” mode” on page 413](#).

TUS mode

“Detect” mode

Detect - (Light Blue) starts when the point value for the survey setpoint begins to rise.

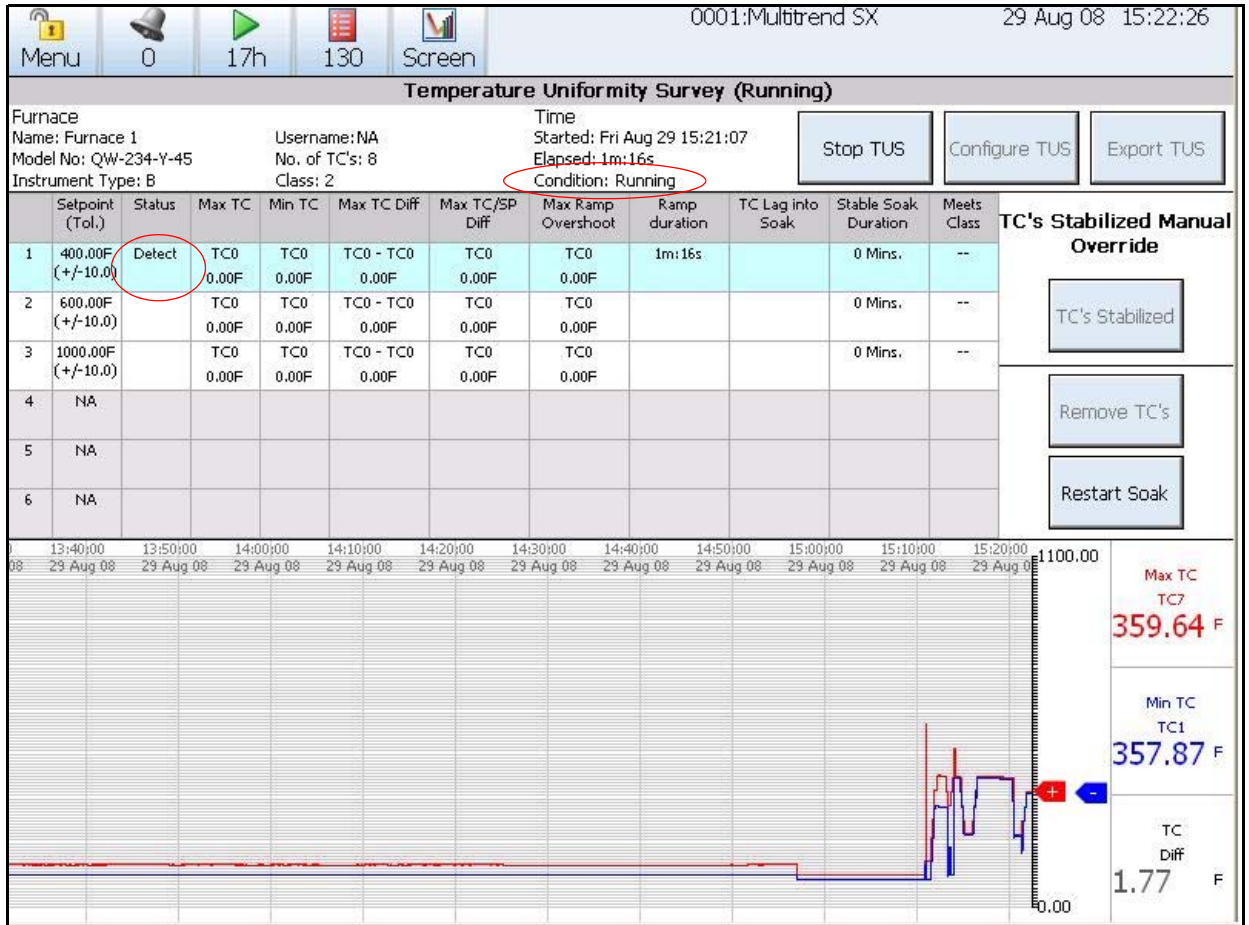

When the recorder is in Detect phase the timers for monitoring the duration of this step will start. At the top of the TUS screen. It will also indicate the process is “Running” along with other status information concerning this particular survey.

The recorder is in “Detect” mode when any or all sensors are outside any of the pre-defined soak temperatures and the point value for that survey setpoint begins to rise.

The recorder monitors all sensors in this mode checking them with each soak level, when all sensors levels fall within one of the soaks for a qualification period of 2 minutes then the recorder proceeds to “in soak” mode.

The “Detect” (out of soak) mode is timed, this tracks the ramp time until “in soak” is achieved.

Temperature overshoot

Temperature overshoot is detected, logged and displayed. An overshoot is deemed as a failure if outside the soak limits defined by the class of the furnace.

Overshoot will be the highest value recorded for a TC after it enters the soak band but before stability occurs. This could be a negative value if the TC does not reach the setpoint before stability is activated.

TUS mode

“Soak” mode

Soak – (Magenta) starts when all T/C’s for the survey are within the tolerance limits for the defined furnace class but stability period has not started.

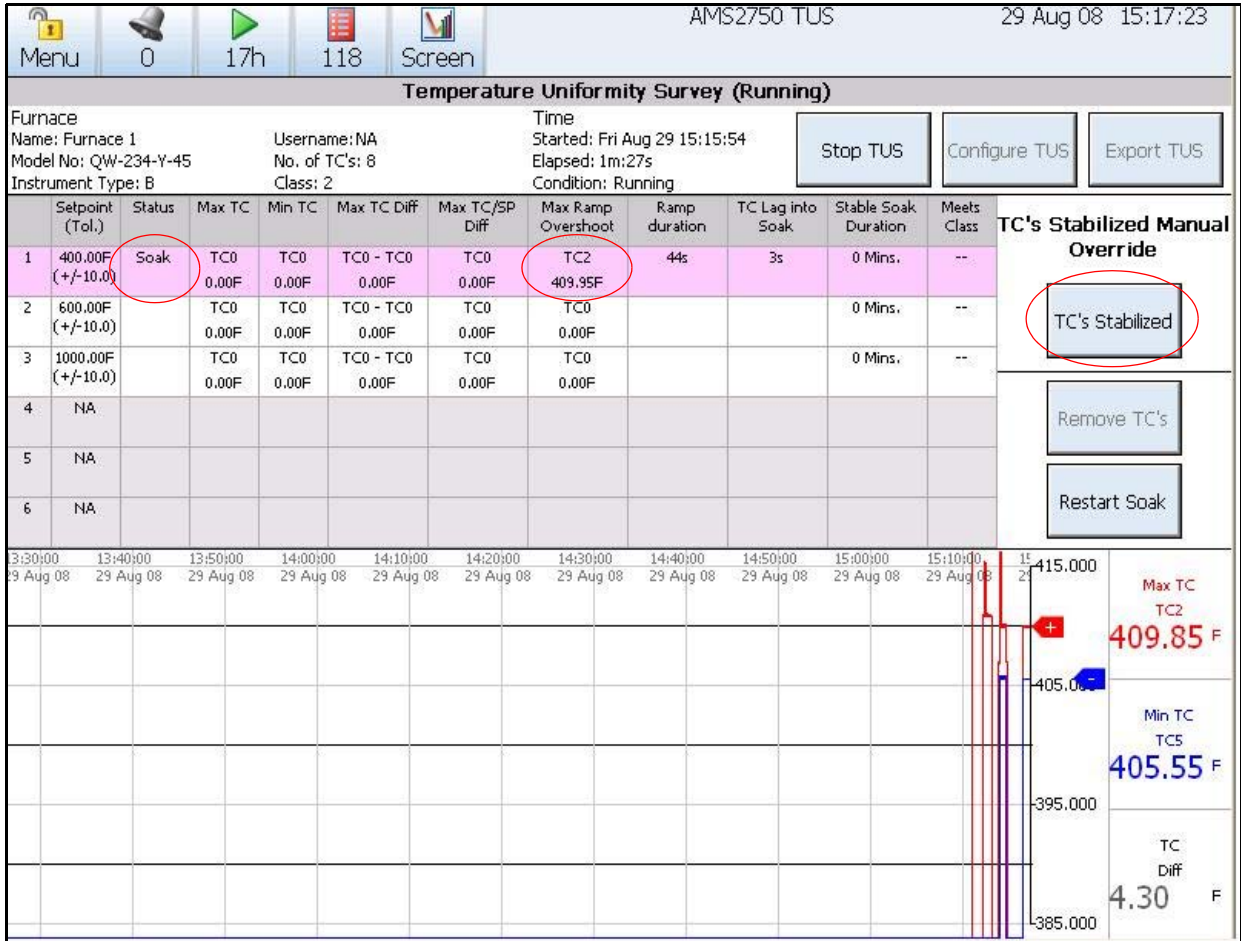

The recorder enters this mode when all sensors have been within the soak tolerance for a qualification period. This is based on the survey setpoint and the defined class of the furnace.

The recorder switches to the second survey phase defined as the “Soak” phase. When this happens the recorder changes the trend graph from a full scale graph to a “Zoomed-in” display. The recorder begins to check for the time it takes before all the survey inputs are within the soak band. The amount of overshoot, if any, and the time it took to reach this first survey setpoint. The recorder starts to monitor all sensors for stability, all sensors must remain stable for 2 minutes in order to progress to “in soak, in stability” mode.

If any sensor falls outside of the soak tolerance, then the recorder falls back to an “out of soak” mode.

The time between the first and last sensors entering soak is recorded.

TC Stabilized

A manual override of “in stability” can be performed. The T/C’s Stabilized button can be pressed if the trend graph shows all requirements are within the defined limits to start this stability run. This button is not active until the stability conditions have actually been met, but once they are achieved, it allows you to start the uniformity test rather than waiting for the pre-defined conditions to be met.

TUS mode

Restart Soak

The setpoint run can be restarted if required. Under certain conditions, the AMS2750 spec allows “bad” T/C’s to be removed from the survey and Restart Soak button provides the ability to do that. These conditions are defined within the AMS2750 spec and depends on the quantities of T/C’s that are in the survey and their relative positions.

“Stable (in soak)” mode

Stable – (Yellow) the actual period that the survey data is being collected.

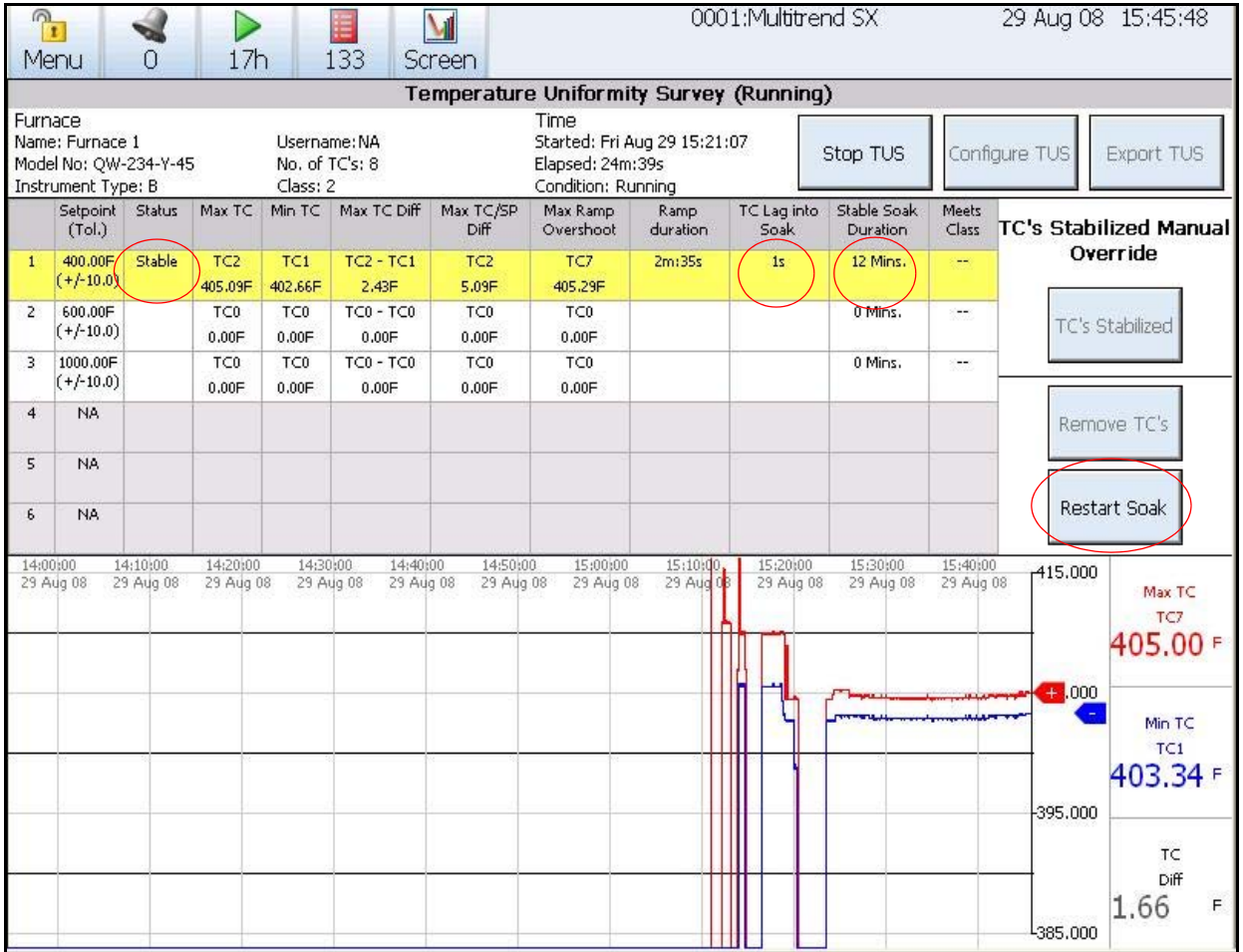

The recorder enters this mode automatically when all sensor signals are within soak AND have remained stable within tolerance limits for the qualification period.

A manual override button is available only when the “in soak” mode has been present for at least 2 minutes. [See “TC Stabilized” on page 412.](#)

A timer is started to measure the stability period achieved, this continues to count up until the configured amount of time for the TUS has been reached.

If at any time one or more sensors fail the stability, but remain “in soak” then the “in soak in stability” recorded history is checked and a new “in soak in stability” time generated. If this time is less than one minute then the mode drops back to “in soak”.

TUS mode

The recorder shows Max, Min and temperature differences for the current survey setpoint and the lag time it took for the first and last TC to enter the soak mode. It also provides a running record of the time that the recorder has been in the Stable mode. The Stable mode is the actual time and reading taken to determine the uniformity of the furnace at this particular setpoint and is the temperature readings that get documented in the Survey Report.

Done

Done – (Red or Green) the setpoint survey step has completed (minimum of 30 minutes) and recorder indicates whether that survey setpoint was successful or not.

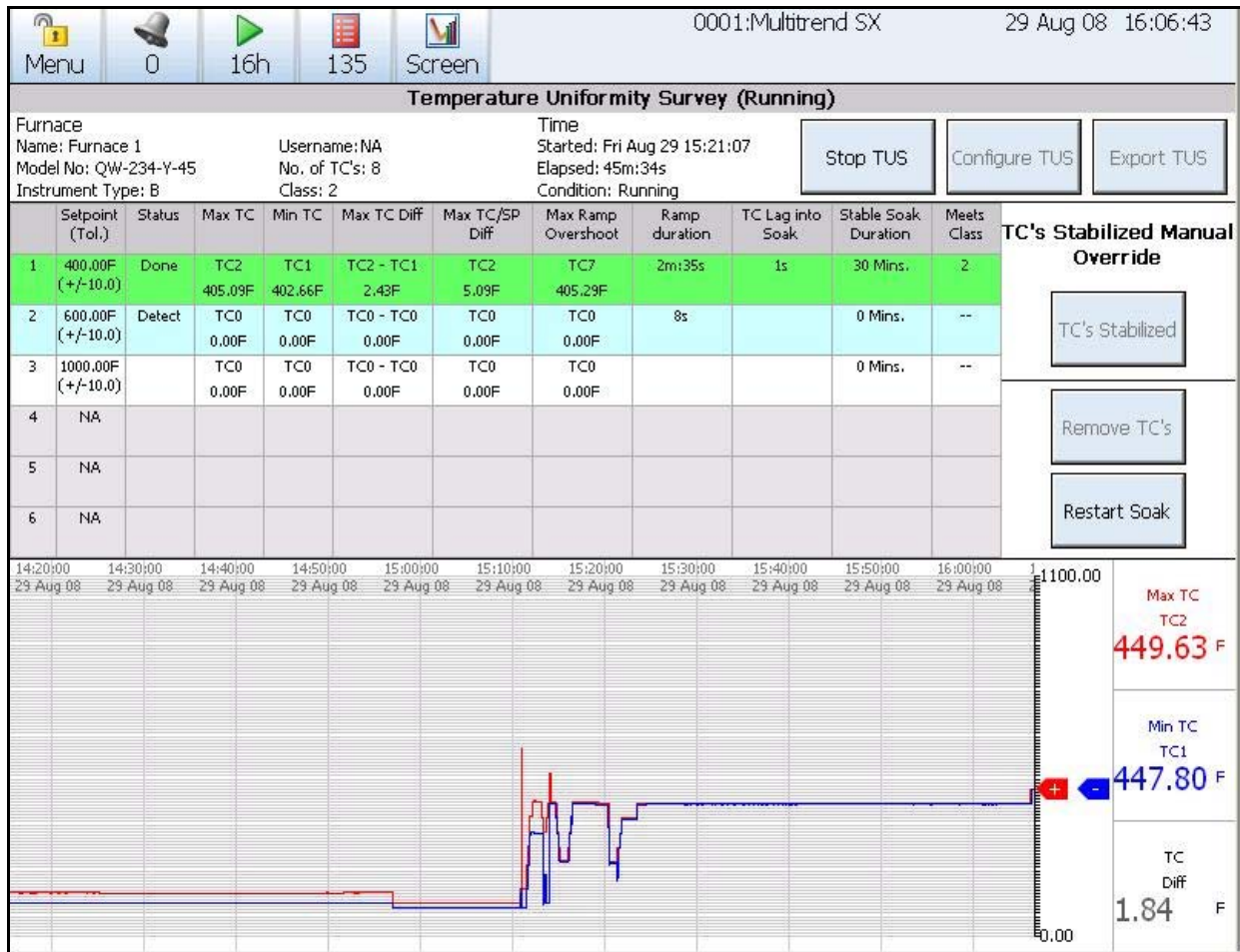

When the Stable time period specified in the recorder's configuration has been satisfied, the recorder will determine if the uniformity survey for that survey setpoint has passed or failed to meet the requirements for the defined class of furnace.

If it passes, this is indicated by setting the colour for this survey setpoint to green and indication the Status as being "Done". It also indicates the level of the furnace class that was actually achieved, which could be better than the class specified in the recorder set up.

If it fails, the indication is shown as Red.

TUS mode

Failure

If a sensor fails during a TUS causing a test “fail”, the recorder allows you to “disable” that particular TC and re run that setpoint. This action is permitted under AMS2750, but the number of TC’s that can be disabled is in accordance with AMS2750, i.e. for a 9 TC test no failures are permitted. The recorder does not take into account TC position when allowing a failed sensor to be removed, and it is your responsibility to ensure conformance with AMS2750.

Remove TC’s

If the TC fails (goes out of tolerance). The “Remove TC’s” button can be used to eliminate that TC from the calculations (setpoint rerun). This will ask you which one is to be removed and do you want to rerun.

This is to allow you to remove the “bad” T/C and redo the survey without having to replace the T/C before repeating the run.

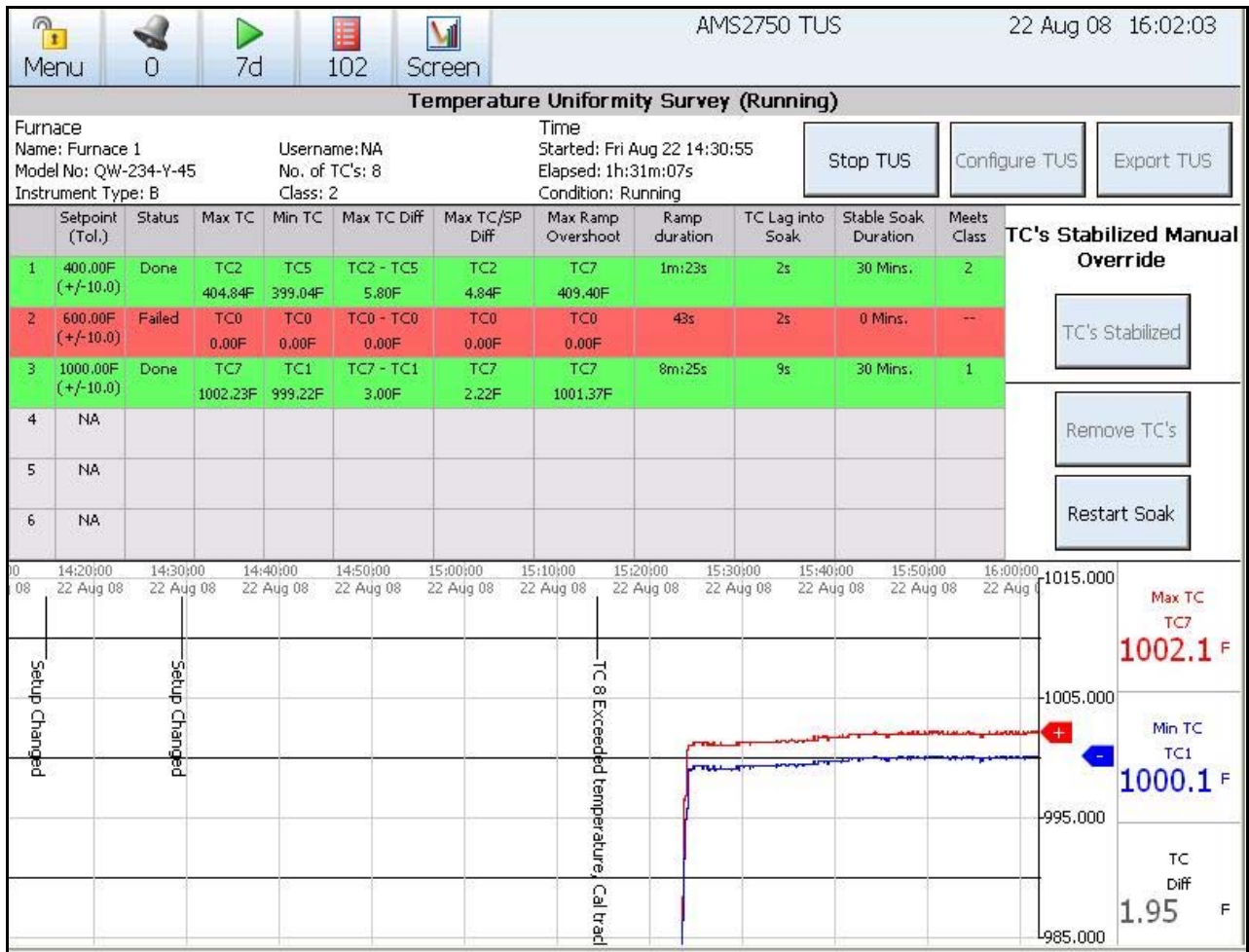

TUS can be stopped at any time. If there is a failure the survey carries on running the test on the others but it is not a valid test because of the failure. All 9 TC’s would have to run again to complete the test with no failures.

Example: 9 TC’s (+ 1 control TC) are required for an oven of a certain size. The sensors are placed in each corner of the rectangular furnace and one in the middle. The control TC is usually placed on the edge of the load. No failures allowed. With 10 -16 TC’s one failure is allowed, see AMS2750 spec for details.

Ending the Survey

This process is repeated until each of the survey setpoints has been completed.

Select Export TUS. A TUS data file is generated with all the relevant information for the AMS2750 Report Generation Tool to produce a survey report.

The user is prompted to enter free format notes which is included in the TUS.

When the entire survey has been completed you can export the TUS data file to the removable media. The file can be exported prior to the completion of all the survey setpoints but those not completed would be indicated as not having been completed when the report is generated.

The data file being exported is a completely separate data file from the recorder's normal saved data (name.tus).

When loaded on the media, this data can be imported to the AMS2750 Report Generation Tool to generate the actual hard copy Temperature Uniformity Survey report. These data files can be saved to a folder on the PC for archival purposes but the AMS275D Report Generation Tool is require to actually open these files and to create the report.

The recorder only archives a single TUS report in the recorder's buffer, the files should be archived in the PC or on a CD for permanent record retention.

The survey ends when the user presses the stop survey button, or the survey runs for a continuous period of 72 hours (including stable time).

A simple report is generated within the recorder that is available as with other recorder based reports.

An event is triggered to indicate a TUS has ended, and a message is logged into the system message list.

Events (AMS2750)

Two new Event Causes have been added:

- **TUS** (Temperature uniformity Survey) - This will only be enabled if the AMS2750 TUS or TUS Process option has been enabled in the recorder credits menu. Select either Start or Stop TUS. When a TUS is started or stopped this can be used to trigger and effect
- **AMS2750 Timer** - This will only be enabled if the AMS2750 TUS or the TUS Process option has been enabled in the recorder credits menu.

A new Event Effect has been added:

- **Update Tabular Readings** - Triggering this event causes the tabular display to update and show the latest set of readings. This does not show any periodic readings, but shows a new line when the "add tabbed data" event effect is triggered.

For full details on Event setup see ["Events Menu" on page 111](#).

Audit Trail (AMS2750)

When running a TUS on the recorder the recorder does provide an audit trail of the actions that occur during the TUS and these can be seen on the trend graph or reviewed as part of the recorder's Message screen. An actual message screen showing the system messages that occurred during the TUS.

Messages

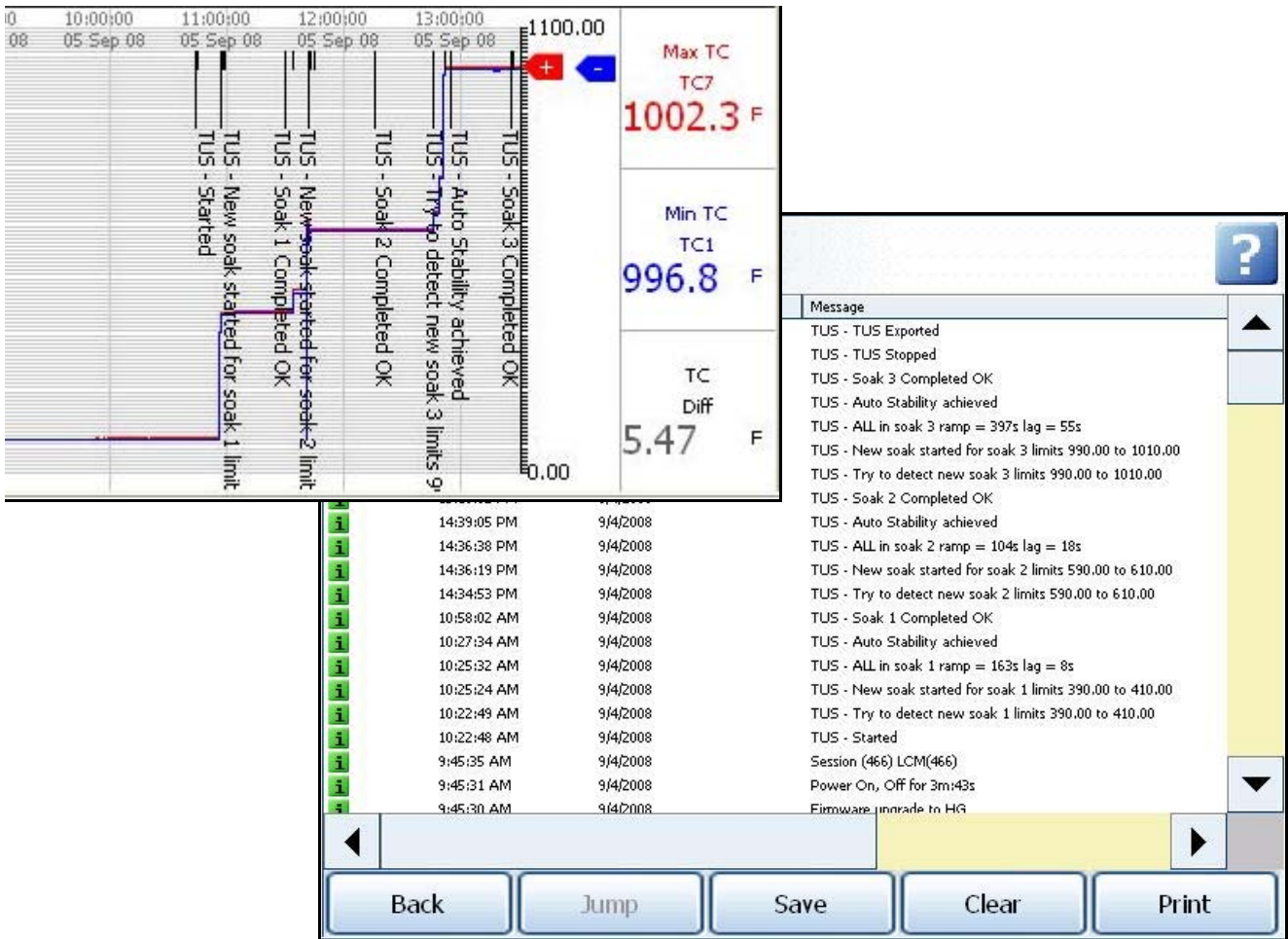

TUS Data file

Once a TUS is stopped a TUS data file is created with all the information required for the AMS2750 Report Generation Tool to produce a TUS report.

The data file is only available for export from the recorder to front CF, USB key or Network Share folder (NAS), the TUS instrument is portable and stand alone and extraction of this file via network is not a requirement.

The .tus file contains logged data at 2 minute intervals. This is independent of the logging in the recorder.

Configuration details, the furnace, sensor and ramp soak configuration details are included within the file.

TUS Logged data

Data is logged for each sensor (pen) within the TUS, at the configured rate. The data is time stamped and any power outages indicated within the format.

The algorithm in the recorder is acquiring data once per sec evaluating the Max and Min TC.

The logging in the TUS is every 2 mins. The chances of the 2 minute data point recording the highest TC reading at the same time as the recorder 1 sec data point is 1 in 120.

Looking at the recorder logged data (1 per/sec) it could show the highest temp TC at 652.3 but the TUS logged data (2 min) might miss that point and its highest recorder TC could be 651.7.

Check the recorder logged data that runs at 1 per sec to find Max & Min TC readings. TUS logged data only logs once every 2 minutes so it will only correspond to the Max Min readings for those data points.

If the logged data is set to 1 per second the readings for Max Min on the TC's are the same as the recorder logged data.

The same data can be logged to other pens for saving to **TrendManager Suite** software for additional analysis

TUS periodic data logging

The data logging for the TUS populates a single set of readings taken from the Data item table of the latest processing cycle, this is aligned to the top of an even minute 2, 4, 6 past the hour for example.

The logging runs on a TUS enabled recorder at all times so when a TUS is started the most recently populated time can be used as the first log.

The data readings are built at the end of the relevant processing cycle on the aligned 2 minute time period, they are compiled into a single record which has a total capacity for 48 inputs.

Each record contains a Date and time, an event indicator, 48 readings and a CRC.

A logged data file is generated on internal SD card, this provides the storage for the full TUS logged data, and will contain only the logged data.

TUS Soak data

The soak information is maintained in a single NV SRAM record, this stores all information relating to Max, Min, deviation and timers for all 48 channels. Only the active channels are populated.

The information will be built up over the period of the ramp/soak. Once a soak have been completed the soak record will be saved to a soak data file.

The soak data file will hold a maximum of 6 soaks and will be pre-generated on the internal SD card in the root directory.

Power loss during TUS

If power is lost during TUS, the TUS resumes when power is re-applied if the power outage has been less than 20 minutes, a power outage of more than 20 minutes automatically stops the TUS when power is re-applied.

If power is lost during TUS and is less than 20 minutes then the TUS automatically resumes, the data is marked that power was lost and the duration for which it was lost.

If power is lost during TUS and TUS is resumed, any uncompleted soak is reset.

Passwords (AMS2750)

The **GR Series** recorders provides full password system to comply with 21CFR Part 11. 50 Users with unique ID & Password, time-outs, expiry of passwords, password definitions and audit trail information.

- Extended Security and Password Capabilities
- Provides security to recorder functions, audit trail of actions
- Password expiration, reuse and password customisation
- 21CFR Part 11 compliant

For full information on the password system and setup, [“Section 5:Security” on page 207](#)

When passwords are enabled in the recorder these are the areas that are password protected.

TUS Screen

The TUS screen can be password protected, if passwords are enabled in the recorder, to prevent unauthorized individuals from starting the TUS. The TUS screen provides controls for the operator that allows them to take some actions relative to the actual data collection process.

Configuration and Start/Stop buttons on the TUS screen

The Configure TUS and Start/Stop buttons are only available when a TUS is not running. If passwords are enabled in the recorder these buttons are password protected. This will restrict unauthorized access to start/stop and configure the TUS.

Thermocouple Usage

Pressing the “configure” button will prompt for a password if passwords are enabled in the recorder. Thermocouple usage tracking is shown as a status screen within the recorder. It shows the current status of the thermocouple within the furnace in process mode.

Process mode

You can reset the date/time for SAT or TUS, providing another new target time/date for the timers. Upon reset a message will be logged into the system message list. If enabled this is password protected for tracking.

Timer reset dialog

When a SAT, TUS, Instrument Cal or Control TC button is pressed they will be challenged to enter user name and password if passwords are enabled. This is to restrict unauthorized access when resetting new dates.

TrendManager SuiteSoftware (AMS2750)

Refer to the **TrendManager SuiteSoftware** manual (43-TV-25-11) for full details on AMS2750 functionality.

AMS2750 includes

- Process or TUS Mode selection in hardware wizard setup
- Furnace configuration for Process and TUS modes
- Setpoint and Stability configuration for TUS mode
- Event Cause to set TC Timers or Alert Timers and Event Cause to Start/Stop TUS.

Screen Designer (AMS2750)

Tabular mode canned screen are configurable from within Screen Designer

The TUS process screen is not accessible from within Screen Designer, this is a fixed screen that is always within a TUS enabled **DR Graphic & Multitrend GR** recorder.

AMS2750 Report Generation Tool

The AMS2750 Report Generation Tool is a stand alone software package and operates independently of the **TrendManager Suite** software. The AMS2750 Report Generation Tool is used for generating a TUS report, using data from the recorder. The AMS2750 Report Generation Tool also provides the ability to produce a SAT template report for manual entry or populated within the tool.

Overview

TUS reports are generated using the self contained data file from the recorder and is outputted in PDF format for printing and sign off.

Data files generated by the recorder are imported directly from the SD card or USB key plugged into the PC, or Network Share folder (NAS). There is no facility for remote communications.

SAT report templates can be generated by the tool from fixed format, the templates can be stored for re-use by furnace.

SAT report templates can be output to PDF and printed for users to fill in manually.

SAT reports templates can be filled out within the AMS2750 Report Generation Tool to produce a completed SAT report, the reports can be exported in PDF format for printing and sign off.

Once a completed TUS or SAT report has been generated you can save it in a location of your choice for easy retrieval.

You are able to save the completed SAT or TUS report (in PDF format) to a specified directory/drive.

The reporting tool is currently only available in English.

Installation

The Report Generation Tool is a stand alone application that is installed separately from the **TrendManager Suites** software, and requires a separate code to enable its use; this will be supplied with the software.

The software is compatible with Windows 7 (32 and 64 bit - Professional, Enterprise and Ultimate Edition), Windows 8 and Windows Server 2008.

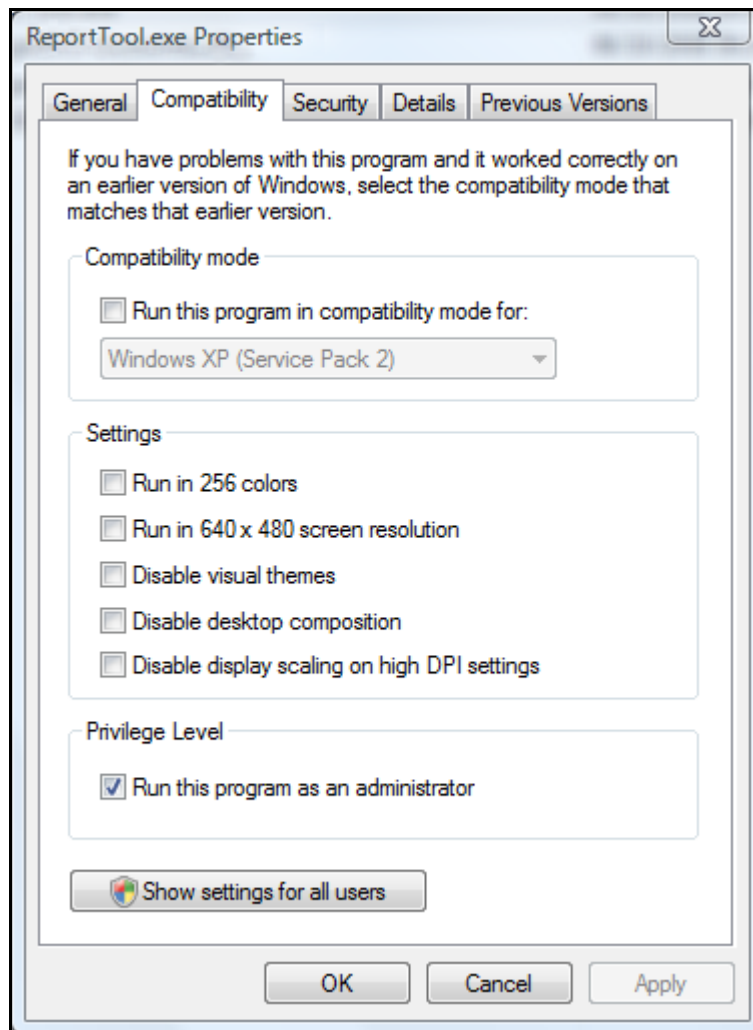

Additional install

Adobe Reader®

The AMS2750 Report Generation Tool generates files in PDF format that you can view and print on the same PC as the AMS2750 Report Generation Tool.

The installer shall prompt you to install a compatible version of Adobe Reader if it is not already installed.

If Adobe Reader is required you will be prompted to begin installation. An installable version is provided on the product envelope.

Introduction

This document provides information regarding AMS2750 Report Generation Tool user interface and will help you in understanding how this application works and what the various screens are.

This application is used to create TUS and SAT Reports based on the AMS275 standard. Reports will be created in PDF format.

Splash Screen

This is the first screen that appears when you run the application. It remains on screen for around one second and then disappears. This indicates that AMS2750 Report Generation Tool application is about to start.

Report Tool User Interface

When the tool opens it will be blank. At the top are two tabs labelled Reports and Help.

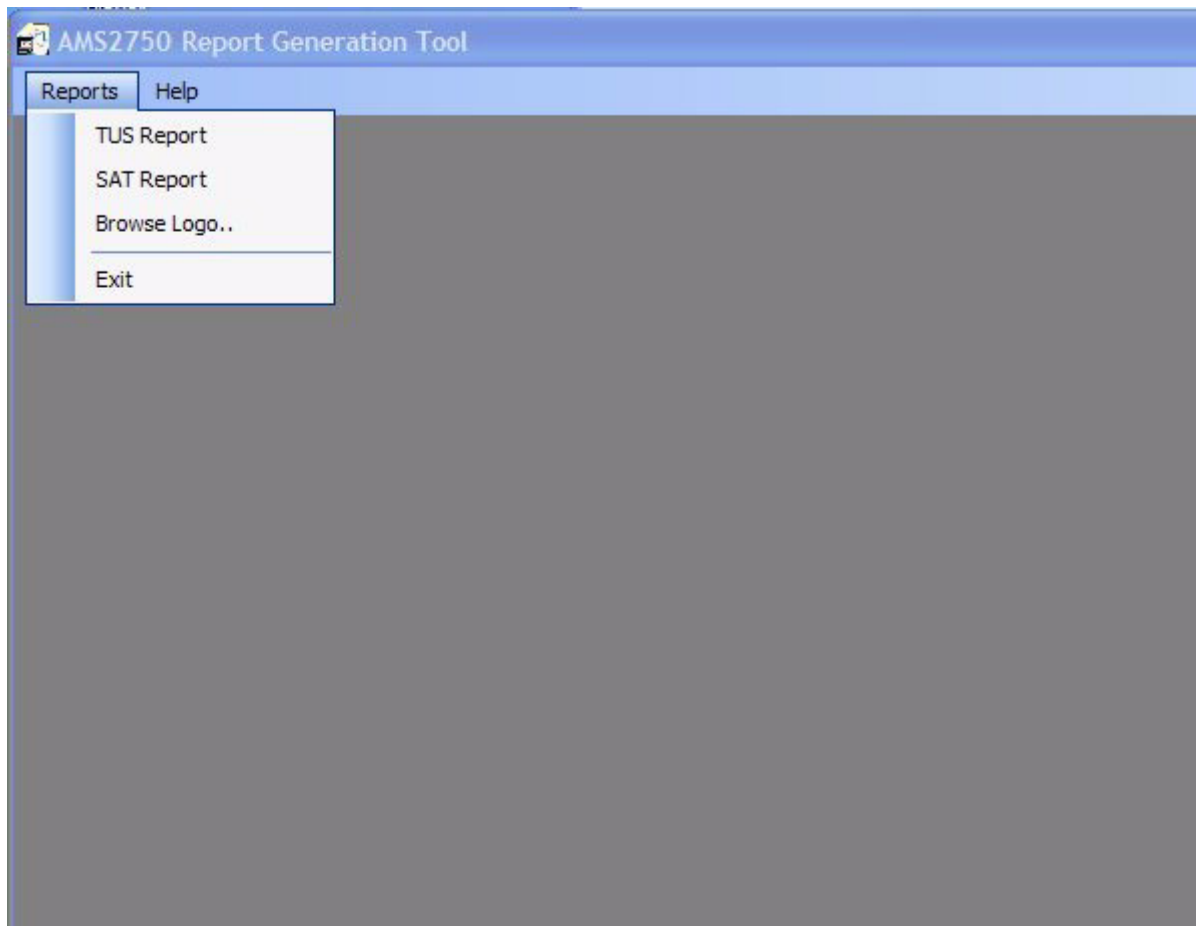

Reports tab - select to create a TUS report or a SAT report using the creation wizard. The Browse Logo option is here so you can select a logo to use as a header on your report. Exit will produce a question asking if you want to close the application, Yes will close the application.

Help Tab - this opens the Help menu and the About sub menu gives version information of the application.

Browse Logo..

You can insert your own company Logo/image which will appear on the top of every page of the generated report. A new folder “Images” will be created after you select “Browse Logo...” and be stored along with the application. When you use a logo it will be stored in this Images folder for future use.

You can select any logo image so long as it is either .bmp or .jpg format. It should not be any bigger than 14mm (0.55”) height) x 63.5 (2.5”) width. Ideal dimensions in pixels are 81x81, 96x96, 300x300.

When the first report with new logo is created, Honeywell.jpg will be saved in “images” folder as a backup for future.

After selecting any logo, another file with name logo .jpg will be created and placed in the images folder. This logo will be used for subsequent reports until user selects another image. If you select logo.jpg again from the Images folder, a message will appear informing you that this file is already selected and prompting you to select another if this one is no longer required.

A backup copy of the Honeywell logo will always be kept at this location with name “Honeywell.jpg”. This can be used at any time to re-use the logo again in the report.

Add a Logo

Select Browse Logo.. and browser the window will open.

Go to where your logo is located and select it by clicking on Open.

This logo will now appear on the top of every page of the generated report. The logo selected will be placed automatically into the Images folder and become the default for subsequent reports until another is selected.

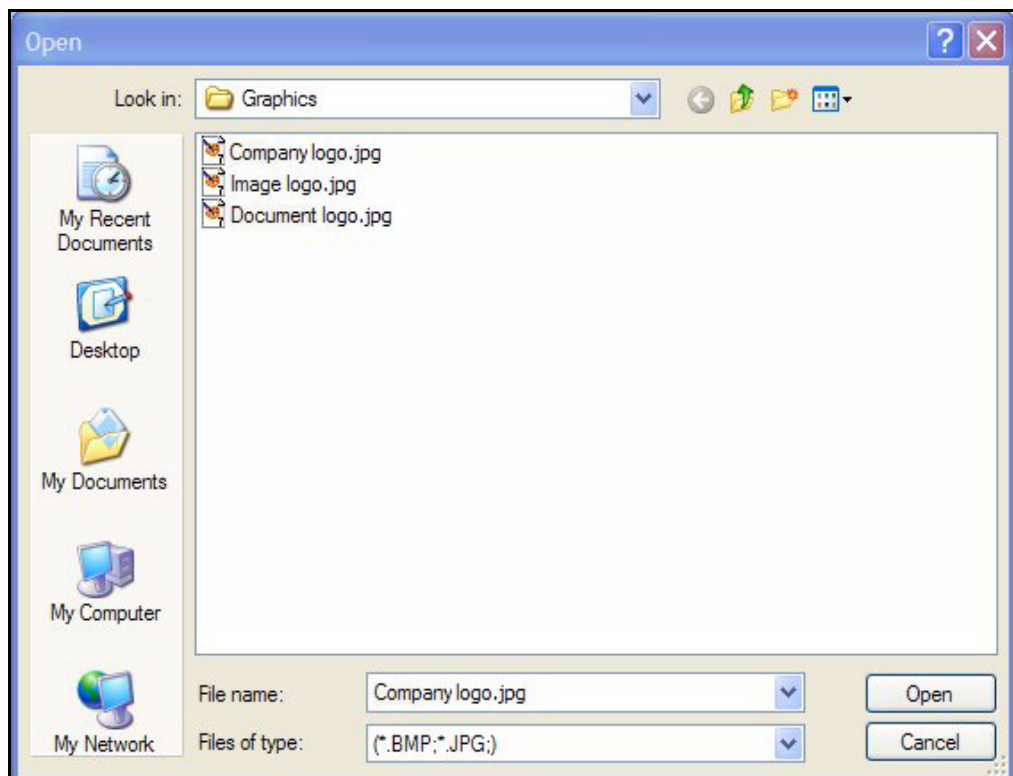

SAT Report Wizard

When you select the SAT Report menu option the wizard will be started. This will help creation of SAT Report.

Step 1 – Obtain information

This information will be printed on the SAT report.

SAT Report Wizard

Please provide information for creating SAT Report.

| | | | |
|------------------|--|---------------------|--------------------------------------|
| Oven Name/ID | <input type="text" value="Furnace 3"/> | Control Sensor | <input type="text" value="T/C 10"/> |
| Manufacturer | <input type="text" value="Big Oven Manufacturer"/> | Tolerance | <input type="text" value="+/- 10F"/> |
| Location | <input type="text" value="Ft. Washington PA"/> | Oven Class | <input type="text" value="2"/> |
| Procedure Number | <input type="text" value="P100-1A"/> | Additional Comments | <input type="text"/> |

If not performed In house

| | |
|--|----------------------|
| SAT Calibration Company Name | <input type="text"/> |
| SAT Calibration Company Representative | <input type="text"/> |

- **Oven Name/ID** - enter the name or ID of the furnace or oven
- **Control Sensor** - enter an identifier for the Control Sensor
- **Manufacturer** - enter Manufacturer of the furnace or oven
- **Tolerance** - of the furnace or oven
- **Location** - enter the location of the company site
- **Oven Class** - Refer to AMS2750
- **Procedure number** - enter a procedure number for the SAT, where applicable
- **Additional Comments** - Add any comments to appear on the report

If the SAT test is not performed In house

- enter - **SAT Calibration Company Name**
- enter - **SAT Calibration Company Representative**

Generate PDF - This will start process of generating SAT Report PDF.

Cancel - Shows message box "Do you like to exit SAT Report Wizard?" If user selects Yes then wizard will be cancelled.

Step 2 – Obtain location to save SAT Report PDF

This screen helps in obtaining the location to save PDF file. Reports can be saved on your local PC, remote machines or on any external devices attached with the machine. Reports can be saved only in the PDF format.

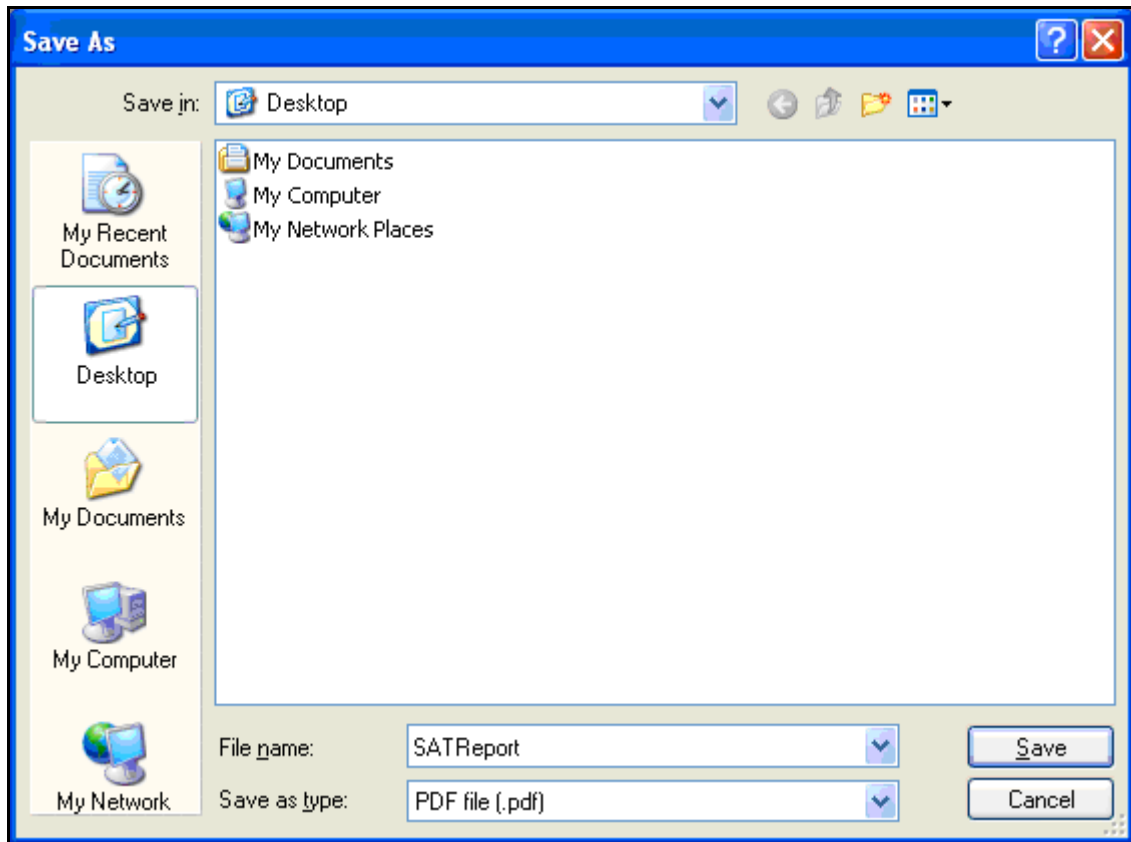

An egg timer message is produced informing you that the report is being created.

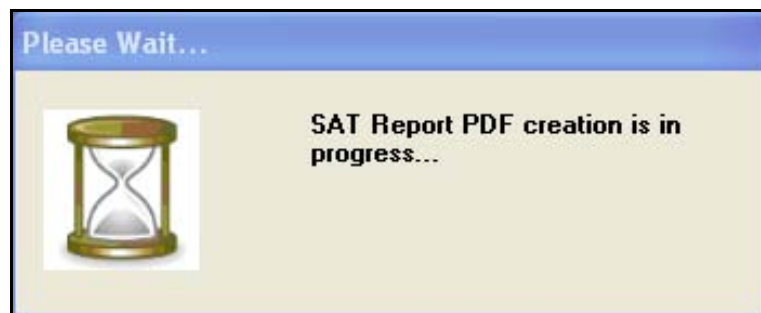

When the report is created a message is produced informing the report has been successfully created and shows the path location to where the file is now saved.

Once the report is created, if appropriate version of acrobat reader is installed then user will be prompted with the message box "Would you like to open/print the generated report?" If user selects "Yes" then report will be opened with installed Acrobat Reader.

The SAT report is complete

SAT Report example

System Accuracy Test Log

Oven Name/ID Furnace 3

Manufacturer Big Oven Manufacturer

Location FL Washington PA

Oven Class 2

SAT Calibration Company Name (If not done in - house) _____

SAT Calibration Company Representative _____

SAT Calibration Company Representative Signature _____

Control Sensor I/C 10

Tolerance +/- 10E

Additional Comments _____

Thermocouple Placement Information

| Date / Time | Controller/Recorder Indication | Uncorrected Test Instrument Reading | Correction for Test TC | Correction for Test Instrument | Corrected Test Instrument Reading | Reading Error | Pass /Fail Tech | Test sensor / Test indicator |
|-------------|--------------------------------|-------------------------------------|------------------------|--------------------------------|-----------------------------------|---------------|-----------------|------------------------------|
| | | | | | | | | |
| | | | | | | | | |
| | | | | | | | | |
| | | | | | | | | |
| | | | | | | | | |
| | | | | | | | | |
| | | | | | | | | |
| | | | | | | | | |
| | | | | | | | | |
| | | | | | | | | |
| | | | | | | | | |
| | | | | | | | | |
| | | | | | | | | |
| | | | | | | | | |
| | | | | | | | | |
| | | | | | | | | |
| | | | | | | | | |
| | | | | | | | | |
| | | | | | | | | |
| | | | | | | | | |

SAT Procedure Number: 100-1A

Approval Sign Off: _____

Engineer Name: _____

REF PROCEDURE: 100-1A

TUS Report Wizard

When you select TUS Report menu option the wizard will be started. This will help creation of the TUS Report.

Appropriate fields such as Instrument Info, Site Info and Furnace layout image are pre-populated with previously entered furnace information if the furnace ID of the currently loaded TUS data file is found to match a previously stored furnace ID. Where no stored information is found the relevant fields will be left as default (usually blank).

Step 1 – Select TUS file

TUS File Location - Enter the TUS file location/ file path or use the browse button to locate the TUS file required to create a TUS report. The file extension for the data file is .tus.

The Next button will validate the TUS file location and move you on to the next screen.

The Cancel button shows a message box “Do you like to exit TUS Report Wizard?” If Yes the wizard is cancelled.

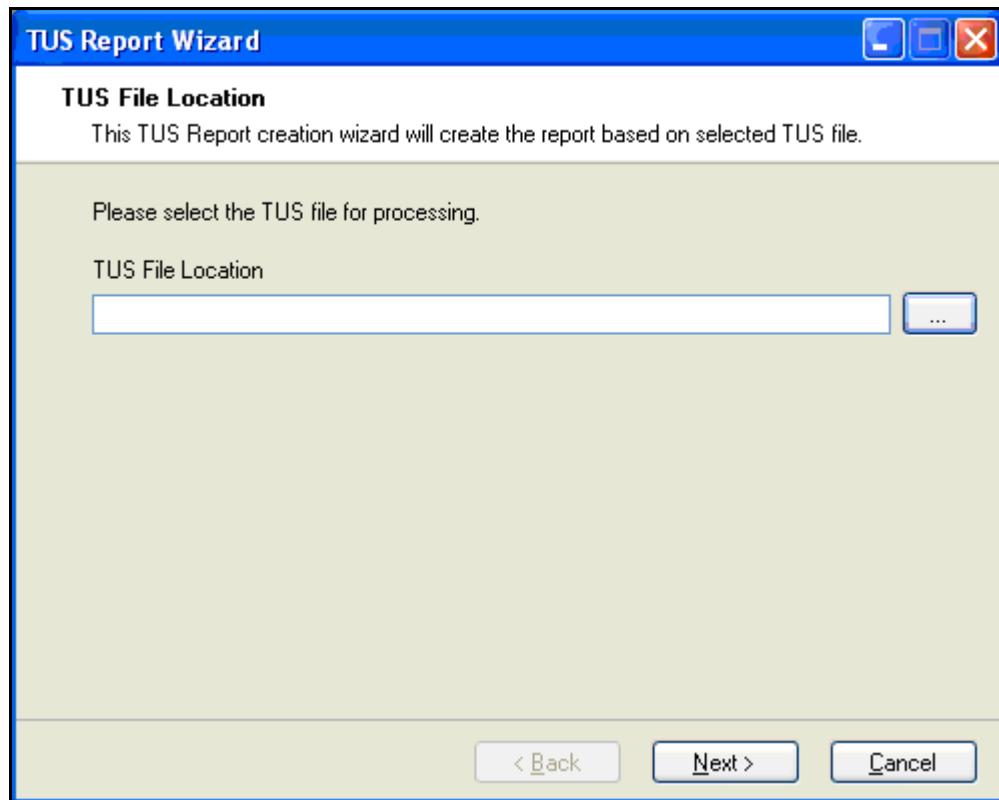

The screenshot shows a Windows-style dialog box titled "TUS Report Wizard". The title bar includes standard minimize, maximize, and close buttons. The main content area has a white header with the text "TUS File Location" and a sub-header "TUS File Location". Below this, there is a line of text: "This TUS Report creation wizard will create the report based on selected TUS file." followed by "Please select the TUS file for processing." and "TUS File Location". A text input field is provided, followed by a browse button (three dots). At the bottom of the dialog, there are three buttons: "< Back", "Next >", and "Cancel".

Step 2 - Certificate and Procedure Number

TUS Report Wizard

Certificate and Procedure Number

Please enter the Report Reference Number for this completed TUS.

Please enter the Procedure Number used for this TUS process.

Next Survey Due Date (Editable MM/DD/YYYY)

| October 2008 | | | | | | |
|--------------|-----|-----|-----|-----|-----|-----|
| Mon | Tue | Wed | Thu | Fri | Sat | Sun |
| 29 | 30 | 1 | 2 | 3 | 4 | 5 |
| 6 | 7 | 8 | 9 | 10 | 11 | 12 |
| 13 | 14 | 15 | 16 | 17 | 18 | 19 |
| 20 | 21 | 22 | 23 | 24 | 25 | 26 |
| 27 | 28 | 29 | 30 | 31 | 1 | 2 |
| 3 | 4 | 5 | 6 | 7 | 8 | 9 |

Next Survey Due Date (Editable MM/DD/YYYY)

Next Survey Date should be greater than current date

Please enter the Report Reference Number for this completed TUS.

Please enter the procedure number used for this TUS process.

Next Survey Due Date (Editable MM/DD/YYYY) - This field is derived from the TUS data file, using the fields: Instrument type (A to E), Material Type (Parts or Raw Material) and Furnace class. Calendar select button is available.

If the next Next Survey Due Date is past the Survey date, a warning box will appear "Next Survey date should be greater than current date", this will be prompted when "Next" is selected.

Step 3 Recorder Certificate Information

This refers to the recorder calibration certificate.

Please enter Calibration Certificate number of the test recorder used to complete the TUS

Enter Certificate Expiry Date (MM/DD/YYYY) - enter the expiry date of the Recorder Calibration Certificate.

If the survey date is past the certificate expiry date, a warning box will be prompted when "Next" is selected. The message says "Certificate Expiry date is past the survey date, would you like to continue?". The generated report shall also highlight the expired date.

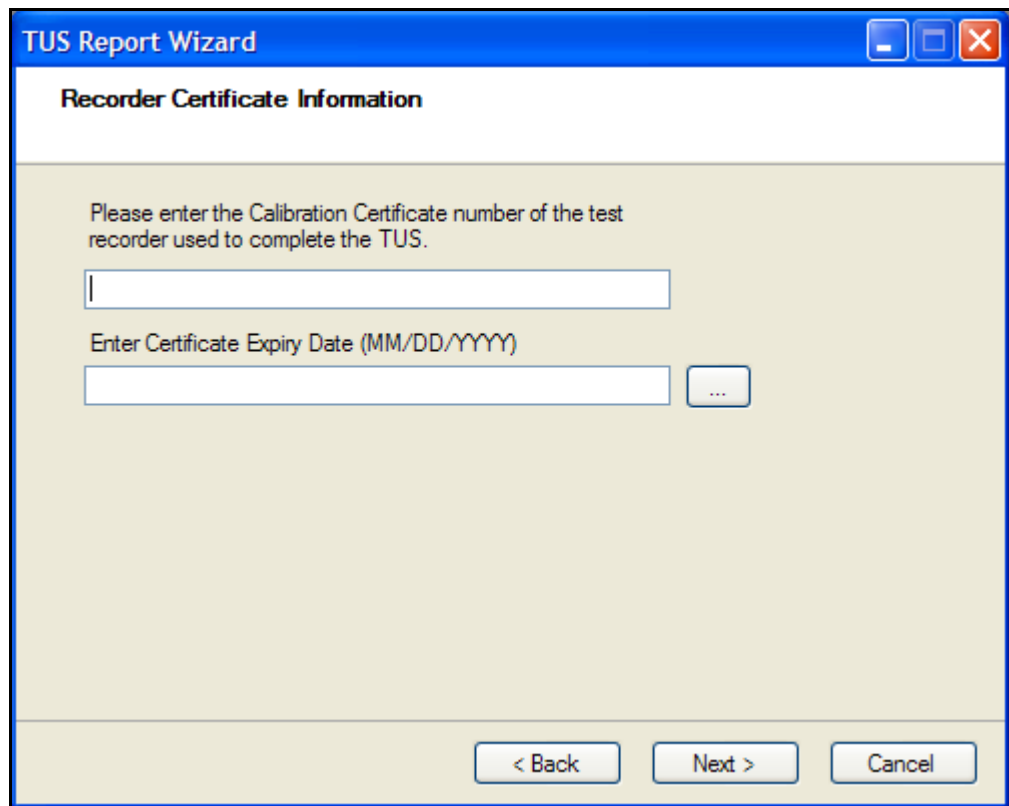

The screenshot shows a Windows-style dialog box titled "TUS Report Wizard". The title bar includes standard minimize, maximize, and close buttons. The main content area is titled "Recorder Certificate Information" and contains the following text: "Please enter the Calibration Certificate number of the test recorder used to complete the TUS." Below this is a text input field. The next line of text is "Enter Certificate Expiry Date (MM/DD/YYYY)", followed by another text input field and a small button with three dots "...". At the bottom of the dialog, there are three buttons: "< Back", "Next >", and "Cancel".

Step 4 – Furnace Instruments

Instruments 1 to 5

There are five instrument information boxes available associated with the furnace/TUS. All the screens are the same as shown here.

Enter the Furnace instrument information, including the instrumentation associated with the furnace, such as the Temperature controller, Recorder etc.

The screenshot shows a Windows-style dialog box titled "TUS Report Wizard". The main title bar is blue with standard minimize, maximize, and close buttons. Below the title bar, the text "Thermal Processing Equipment Instruments - Instrument 1" is displayed. The main area has a light beige background and contains the following text: "Please enter the details for the control, measuring and recording instrumentation of the Thermal Processing Equipment. This information will be included in the TUS report." Below this text are seven input fields, each with a label to its left: "Purpose", "Asset Tag", "Model ID", "Serial Number", "Cal. Certificate No.", "Cal. Due Date", and "(MM/DD/YYYY)". The "Cal. Due Date" field has a small "..." button to its right. At the bottom of the dialog box, there are three buttons: "< Back", "Next >", and "Cancel".

Purpose - what is it used for a part or raw material.

Asset Tag - enter for the instrument

Model ID - Model number of the instrument

Serial Number - Serial number of the instrument

Cal. Certificate No. - Calibration certificate number for the furnace/instrument

Cal. Due Date (MM/DD/YYYY) - If date is valid then it is compared with Survey Date and if the date is past the survey date then message box will be shown that "Calibration Due Date is past the Survey Date, would you like to continue?"

The number of instrument boxes to be completed depends on the furnace class and the instrumentation used on the furnace, complete as many as required based on AMS2750.

Step 5 Furnace Comments

Enter the serial number for the furnace or oven.

Allows you to enter any general comments concerning the furnace; these will be included in the report.

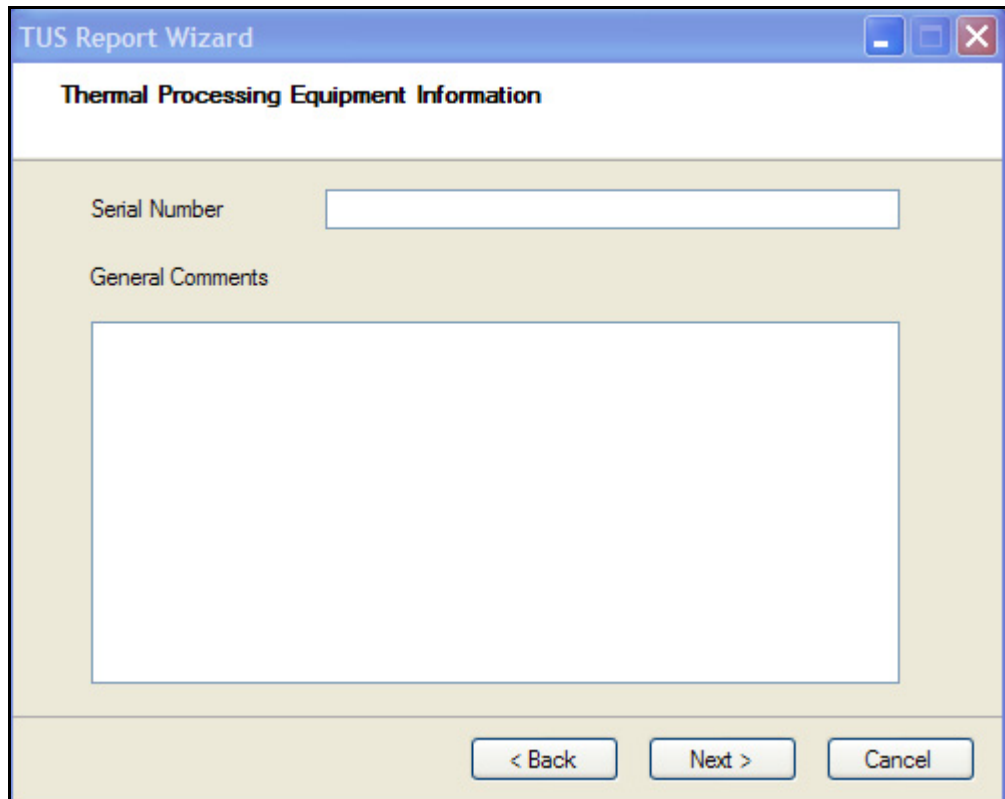

The screenshot shows a Windows-style dialog box titled "TUS Report Wizard". The main heading inside the dialog is "Thermal Processing Equipment Information". Below this heading, there are two input fields: "Serial Number" followed by a single-line text box, and "General Comments" followed by a larger multi-line text area. At the bottom of the dialog, there are three buttons: "< Back", "Next >", and "Cancel".

AMS2750 Report Generation Tool

Step 6 Site Information

Enter the Customer Name, Location Address and Contact Name that will be entered onto the report.

Please enter the name of the Survey Testing Company if the survey is not performed in-house. If the survey is performed in house this field can be left blank. Customer specific Process information can be entered for Job Name, Customer Name and Comments.

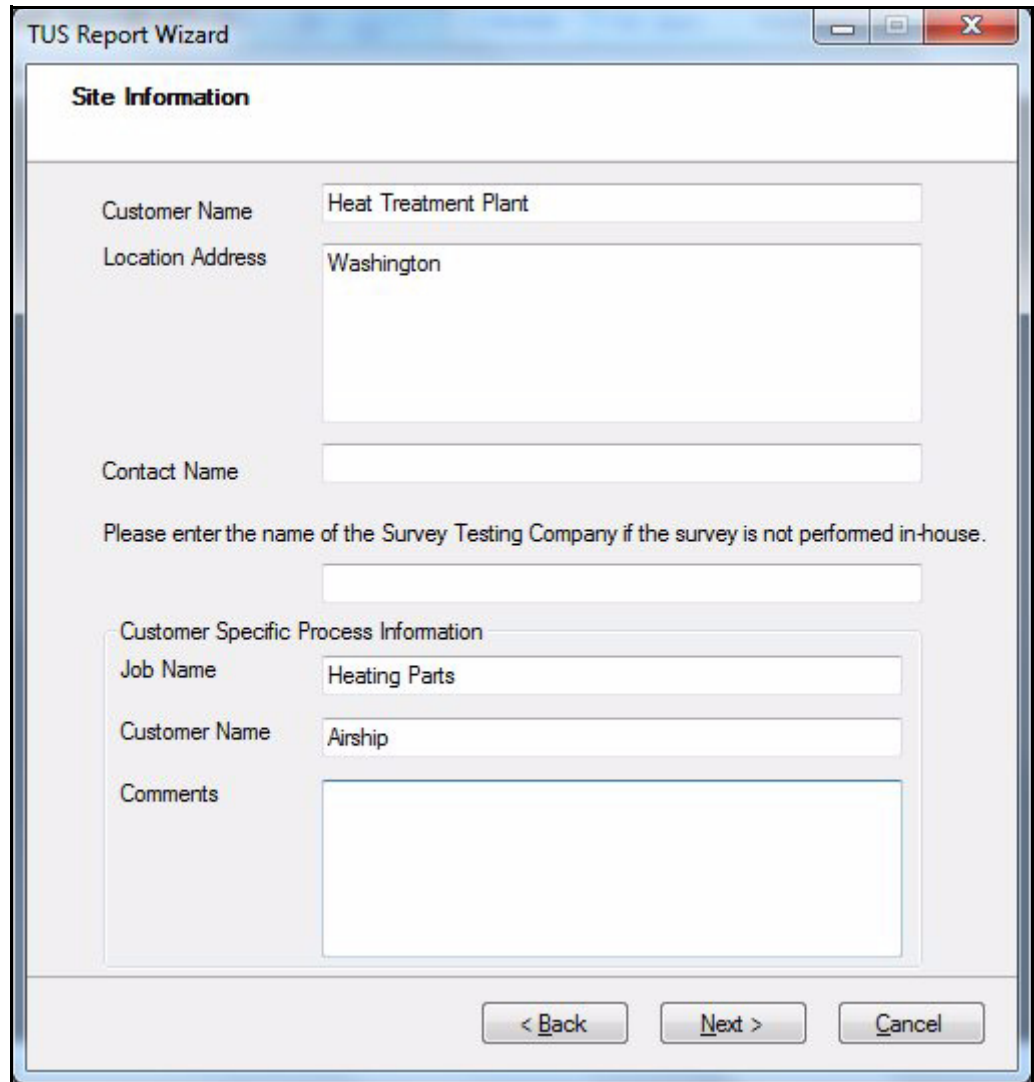

The screenshot shows a Windows-style dialog box titled "TUS Report Wizard". The main heading is "Site Information". The form contains the following fields and text:

- Customer Name: Heat Treatment Plant
- Location Address: Washington
- Contact Name: (empty)
- Please enter the name of the Survey Testing Company if the survey is not performed in-house. (empty)
- Customer Specific Process Information:
 - Job Name: Heating Parts
 - Customer Name: Airship
 - Comments: (empty)

At the bottom of the dialog box are three buttons: "< Back", "Next >", and "Cancel".

Step 7 Furnace Thermocouple Positioning

This screen is used to show the positions of thermocouples inside the furnace. This will default to the image of 9 thermocouples rectangular/square. The down arrow will provide more options for commonly used layouts found for survey layouts.

These are static bitmap images and cannot be changed; care needs to be taken to make sure that the position of the T/C as positioned in the furnace matches the diagram.

Add and references or comments in "Add Notes". These will appear in the TUS report.

Alternatively you can upload your own "Custom" layout (graphic image).

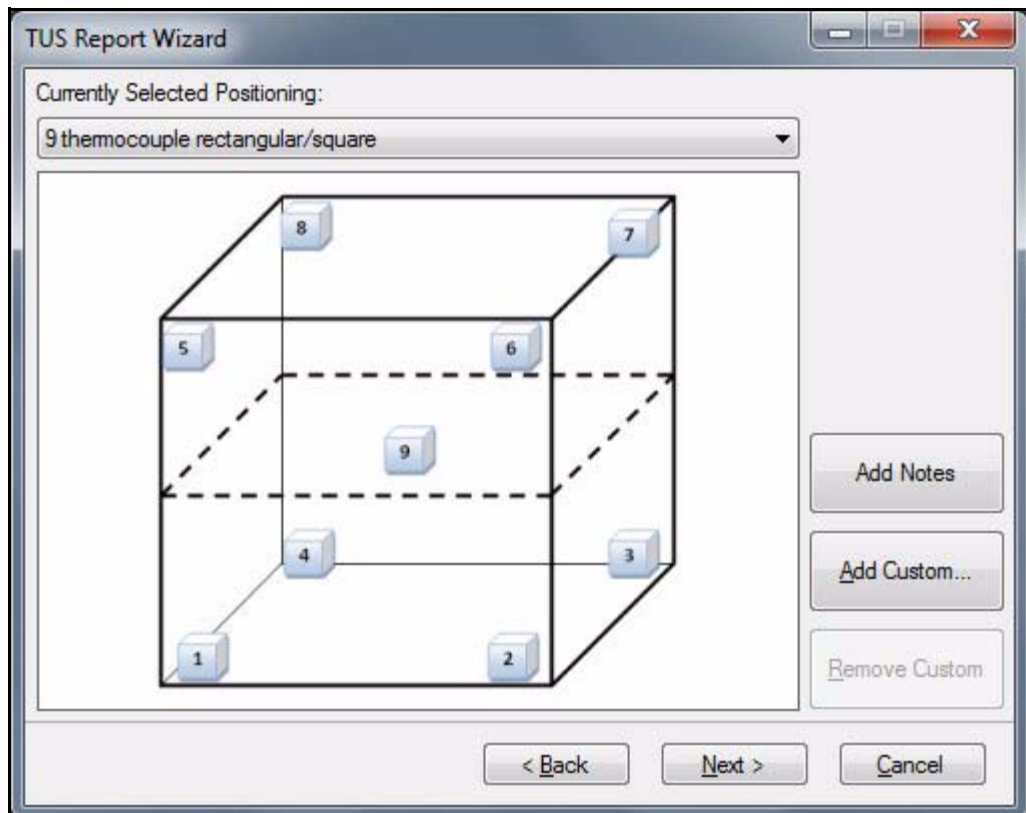

Default layouts include:

- 9 thermocouple rectangular/square
- 5 thermocouple rectangular/square
- 5 thermocouple cylindrical
- 9 thermocouple cylindrical (A)
- 9 thermocouple cylindrical (B)

Add Notes - Allows the user to add furnace identification details or other notes related. This will reflect in TUS Report.

Add Custom - Allows user to add custom images. The TC Positioning Layout Form will be displayed, see "[TC Positioning Layout Form](#)" on page 435. Custom images are the re-

AMS2750 Report Generation Tool

sponsibility of the user and the AMS2750 Report Generation Tool will notify you if the image fails to meet certain requirements ie. file type, size limitations.

Remove Custom Button - This button remains enabled for only custom images. If this button is pressed it removes the selected image from the database.

TC Positioning Layout Form

When “Add Custom” button is used the TC Positioning Layout box appears so you can upload your own image.

Enter the Layout name and then select the “Upload Image” button

Upload Image - Once image is selected it will be shown in Thermocouple Layout image box. Image should be in BMP or JPEG format. Supported image size is around 260 x 250 pixels. If the image is not supported then Error icon is shown besides the “Thermocouple Layout image” label.

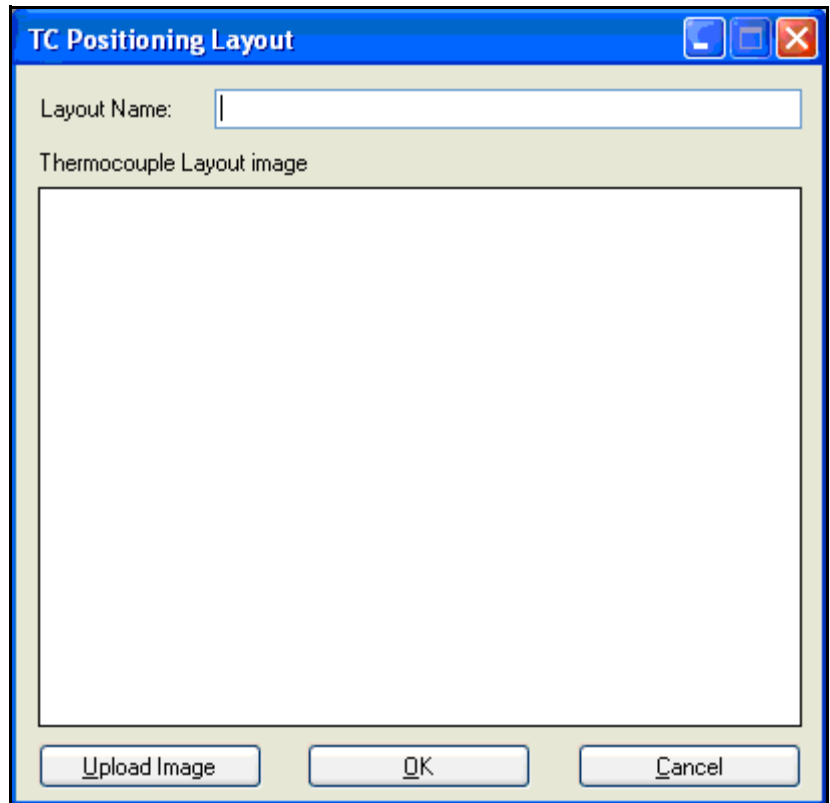

The image shows a Windows-style dialog box titled "TC Positioning Layout". It has a blue title bar with standard window controls (minimize, maximize, close). The main area is light gray and contains a text input field labeled "Layout Name:" with a vertical cursor. Below this is a label "Thermocouple Layout image" above a large, empty rectangular area intended for an image. At the bottom, there are three buttons: "Upload Image", "OK", and "Cancel".

Step 8 - TUS Offset Information

These are offsets information; "As Found" and "As Left", in which customer would put into the controller to create a bias if they needed to do.

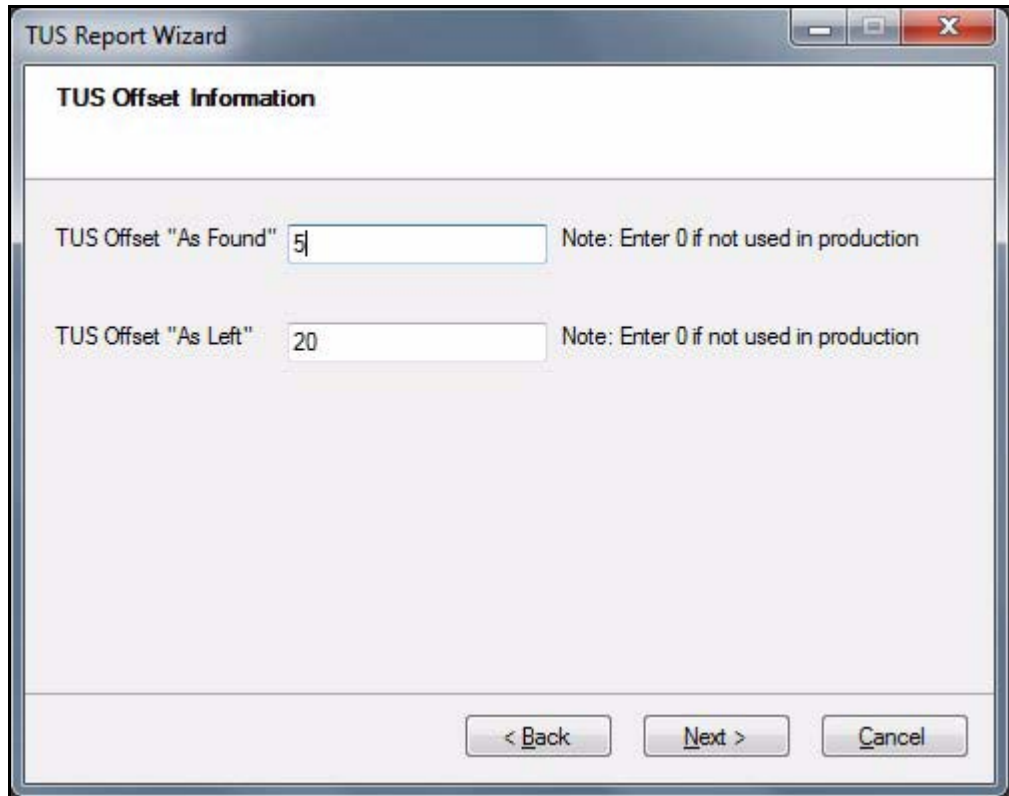

The screenshot shows a window titled "TUS Report Wizard" with a sub-header "TUS Offset Information". It contains two input fields: "TUS Offset 'As Found'" with the value "5" and "TUS Offset 'As Left'" with the value "20". Each field has a note: "Note: Enter 0 if not used in production". At the bottom, there are three buttons: "< Back", "Next >", and "Cancel".

| Field | Value | Note |
|-----------------------|-------|---|
| TUS Offset "As Found" | 5 | Note: Enter 0 if not used in production |
| TUS Offset "As Left" | 20 | Note: Enter 0 if not used in production |

Step 9 – Plot Readings Form

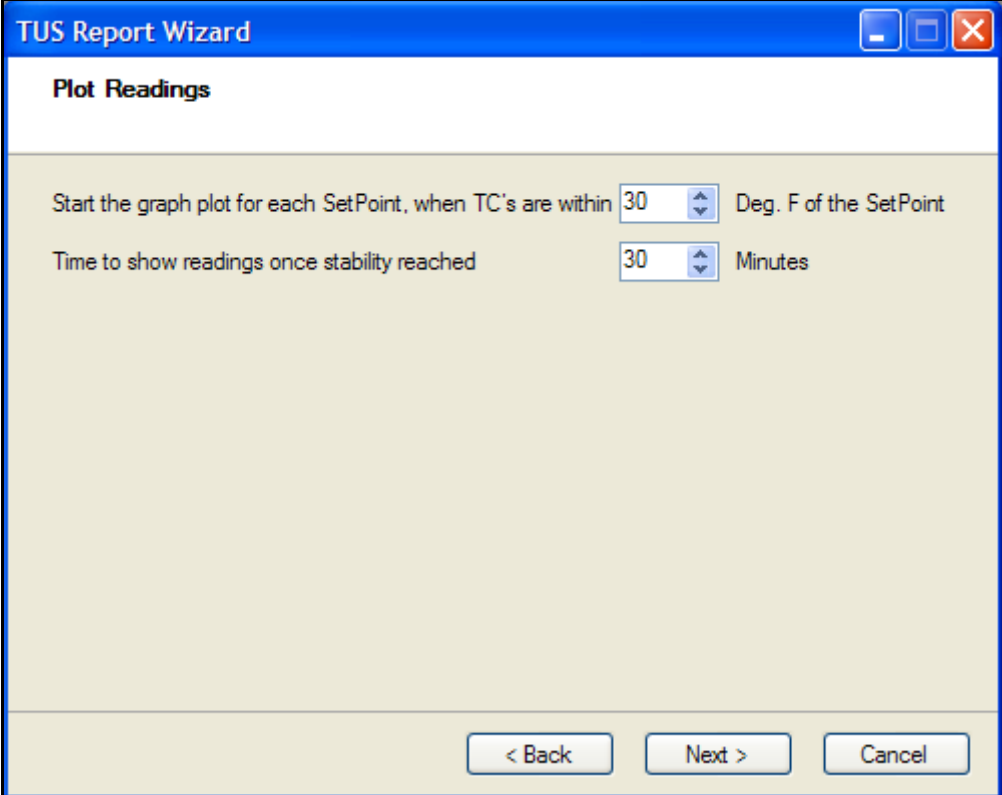

The screenshot shows a window titled "TUS Report Wizard" with a "Plot Readings" section. It contains two input fields with spinners. The first field is labeled "Start the graph plot for each SetPoint, when TC's are within" and has a value of "30" followed by "Deg. F of the SetPoint". The second field is labeled "Time to show readings once stability reached" and has a value of "30" followed by "Minutes". At the bottom of the window are three buttons: "< Back", "Next >", and "Cancel".

Start the graph plot for each Setpoint, when TC's are within "X" Deg of the Setpoint - This indicates that it will only start the readings table and graph once all thermocouples are within "X" degrees of setpoint. For example: A setpoint is at 100 Deg C and you enter 30 then it will start plotting when all thermocouple readings reach to 70 Deg C. This does not affect the data in the TUS file, only the data being graphed for the report.

Time to show readings once stability reached "X" Minutes - This is to allow only specified period of recorded data to be in tabular form after TC's are defined as "stable" or until the temperature moves outside the range detailed. For example "Only 30 minutes of data shall be in tabular form once stability has been reached"

Step 10 - Results and Affirmation

This screen summarises each setpoint temperature result by stating which furnace class it met during the TUS, and prompts you to enter general survey comments, and an affirmation field where you will make the statement as to whether the survey is a pass or fail.

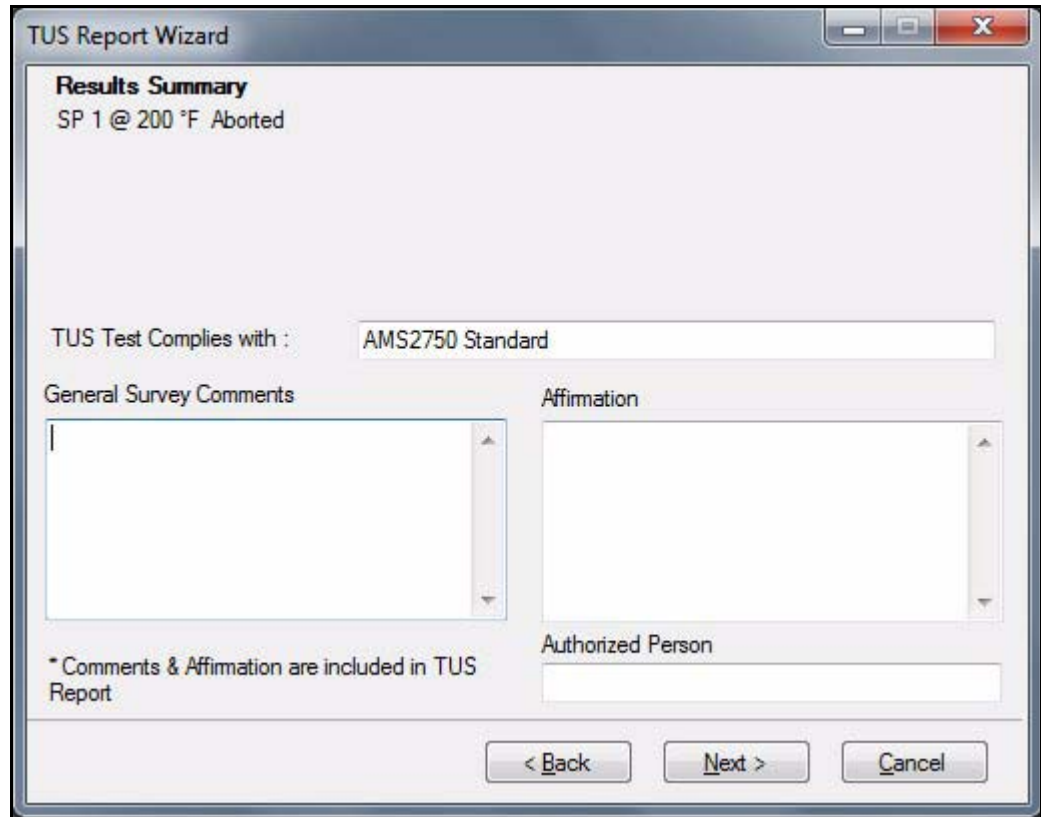

The screenshot shows a window titled "TUS Report Wizard" with a standard Windows-style title bar (minimize, maximize, close buttons). The main content area is divided into several sections:

- Results Summary:** Displays "SP 1 @ 200 °F Aborted".
- TUS Test Complies with:** A text box containing "AMS2750 Standard".
- General Survey Comments:** A large, empty text area with a vertical scrollbar.
- Affirmation:** A large, empty text area with a vertical scrollbar.
- Authorized Person:** A text box for entering the name of the person creating the report.
- Footer:** A note stating "* Comments & Affirmation are included in TUS Report" and three buttons: "< Back", "Next >", and "Cancel".

TUS Test Complies with: AMS 2750 or other processing specifications. Enter any other compliance required to additional specifications (e.g. Mil-6875, BAC-5621, etc.)

Enter any text required into the General Survey Comments & Affirmations field.

Enter the name of the Authorized Person who is creating the TUS report.

Step 11 - Save TUS Report

This screen helps in obtaining the location to save the PDF file. Reports can be saved on your local PC, remote machine or on any external devices attached with the machine. Reports can be saved only in the PDF format.

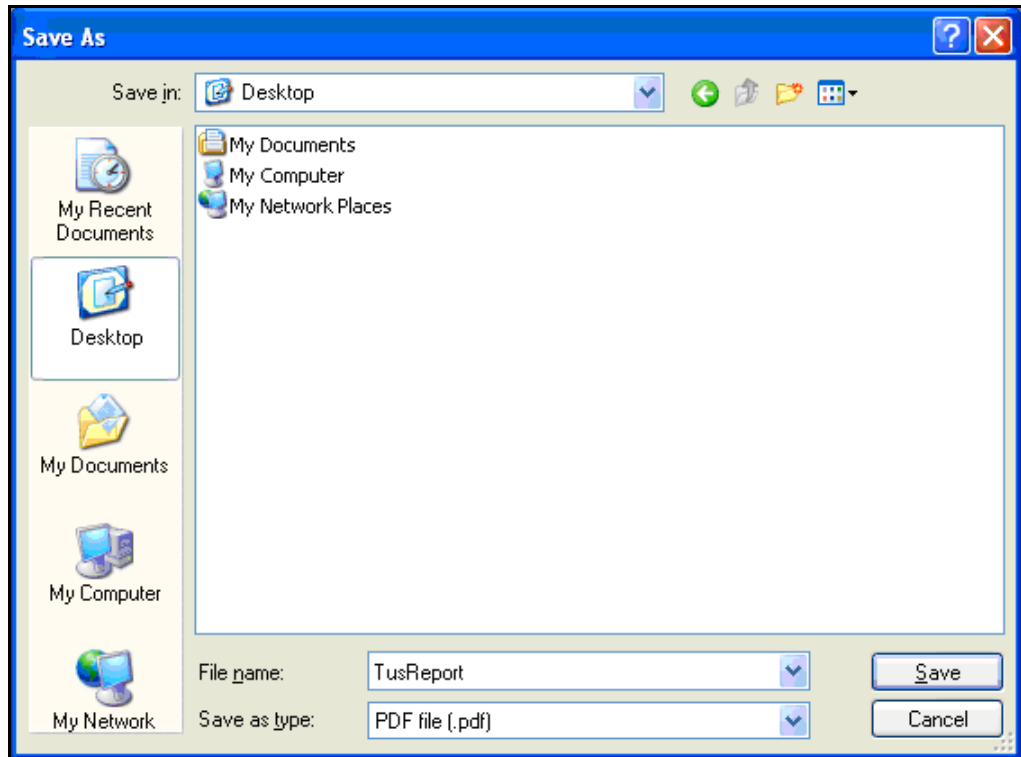

An egg timer message is produced informing you that the report is being created.

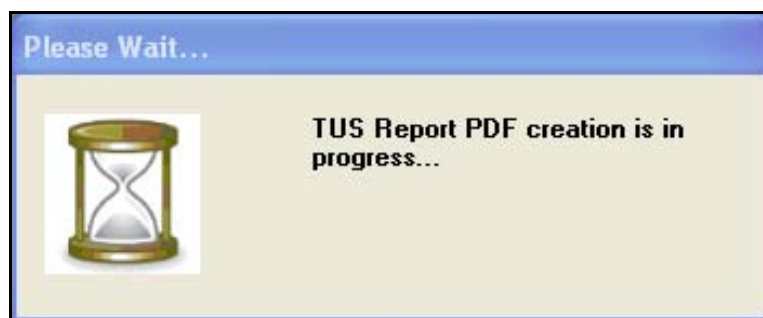

When the report is created a message is produced informing the report has been successfully created and shows the path location to where the file is now saved.

Print TUS Report

Once the report is created, if appropriate version of acrobat reader is installed then user will be prompted with the message box "Would you like to open/print the generated report?" If user selects "Yes" then report will be opened with installed acrobat reader tool.

The TUS report is complete

A final dialog appears asking if you wish to exit the application

Header and Footer report information

The header and footer information that is auto-displayed on the report includes:

Header

- Report Reference Number
- Customer Name or Reference
- Furnace Tag, Name or Reference
- Logo option

Footer

The Footer information includes:

- Page Number of total number
- Report Generated by ** TUS Report Tool"

AMS2750 Report Generation Tool

TUS Report - Example

The next few pages show selected pages from a sample test TUS report

| | | | |
|---|--|--|---|
| Report Reference Number: 345 | | | |
| Customer: Heat Treatment Plant | | | |
| Equipment: Furnace 1 | | | |
| Temperature Uniformity Survey Report | | | |
| Site Information | | | |
| Customer | | Heat Treatment Plant | |
| Location Address | | Washington | |
| Contact Name | | | |
| Customer Specific Process Information | | | |
| Job Name | | Heating Parts | |
| Customer Name | | Airship | |
| Comments | | | |
| Thermal Processing Equipment | | | |
| Equipment Name | | Furnace 1 | |
| Equipment Manufacturer | | Schindler | |
| Furnace Class | | 2 | |
| Model Number | BS001 | Serial Number | |
| Material Type | Parts | Instrument Type | B |
| Comments | | | |
| Survey Affirmation | | | |
| Report Reference Number: 345 | | | |
| Issue Date: 6/5/2013 | | | |
| Affirmation: | | | |
| TUS Test Complies with: AMS2750 Standard | | | |
| Customer Signature: | | Date: | |
| Engineer: | | Date: 6/5/2013 | |
| Approved | Signed: | Date: | |
| | Printed | | |
| Temperature Uniformity Class Achieved By Set Point | | | |
| SP1 950.0 °F | Met the requirements of Class 1 Furnace | Survey Passed <input type="checkbox"/> Failed <input type="checkbox"/> | |
| SP2 1200.0 °F | Met the requirements of Class 1 Furnace | Survey Passed <input type="checkbox"/> Failed <input type="checkbox"/> | |
| Report Generated By AMS2750 TUS Report Tool | | | |
| All measured values (except the control TC) are corrected | | | |
| Page: 1 of 12 | | | |

AMS2750 Report Generation Tool

Sample pages taken from a test TUS report

| | |
|---|--|
| Report Reference Number: 345 | |
| Customer: Heat Treatment Plant | |
| Equipment: Furnace 1 | |
| Max Difference across Survey TC's During Measurement | |
| | Difference in °F |
| SP1 950.0 °F | 2.8 |
| SP2 1200.0 °F | 4.6 |
| <i>All channels shown are corrected</i> | |
| Max Difference between Survey TC's & Controller Setpoint During Measurement | |
| | Difference in °F |
| SP1 950.0 °F | 2.6 |
| SP2 1200.0 °F | 3.8 |
| <i>All channels shown are corrected</i> | |
| Maximum Ramp Overshoot | |
| | In °F |
| SP1 950.0 °F | 2.5 |
| SP2 1200.0 °F | 3.8 |
| <i>All channels shown are corrected</i> | |
| Ramp Duration - Measured from last TC to leave Previous Dwell, to last TC to Enter Next SP | |
| | Ramp Time - HH:MM:SS |
| SP1 950.0 °F | 00:03:02 |
| SP2 1200.0 °F | 00:00:38 |
| <i>All channels shown are corrected</i> | |
| TC Lag - Time Between 1st TC to Enter Dwell Zone, to last TC to Enter Dwell Zone | |
| | Lag Time - HH:MM:SS |
| SP1 950.0 °F | 00:00:06 |
| SP2 1200.0 °F | 00:00:05 |
| <i>All channels shown are corrected</i> | |
| Survey Comments | |
| Pre TUS Instrument Comments | bld ortest1 |
| Post TUS Instrument Comments | All soaks have been completed the survey was stopped automatically |
| Survey Details | |
| Recorded Data File | 9TCS.tus |
| Temperature Units | °F |
| Survey Instrument Type | X-Series SX Recorder |
| Survey Instrument Serial No. | 806295 |
| Report Generated By AMS2750 TUS Report Tool | |
| All measured values (except the control TC) are corrected | |
| Page: 2 of 12 | |

AMS2750 Report Generation Tool

Sample pages taken from a test TUS report.

| | |
|---|-------------------|
| Report Reference Number: 345 | |
| Customer: Heat Treatment Plant | |
| Equipment: Furnace 1 | |
| Survey Instrument Certificate No. & Expiry Date | JUXA593 |
| Procedure Number | |
| Data Interval | 120 Seconds |
| Start Time & Date | 1/7/2009 15:26:46 |
| End Time & Date | 1/7/2009 16:36:03 |
| Next Survey Due | 1/21/2019 |
| Survey Engineer | NA |
| Identification Of the Testing Company (If not performed In House) | |
| Signature for the Testing company (If not performed In House) | |

| Survey SetPoint Temperatures | | | |
|------------------------------|-------------|---------------|---------------|
| | Temperature | Tolerance | Furnace Class |
| Set Point 1 | 950.0 °F | +/- 10.000 °F | 2 |
| Set Point 2 | 1200.0 °F | +/- 10.000 °F | 2 |

| Test Thermocouple Identification | | |
|----------------------------------|------------|-------------------------|
| | Serial No. | Report Reference Number |
| TC1 | Itc001 | celcr001 |
| TC2 | Itc001 | celcr001 |
| TC3 | Itc001 | celcr001 |
| TC4 | Itc001 | celcr001 |
| TC5 | Itc001 | celcr001 |
| TC6 | Itc001 | celcr001 |
| TC7 | Itc001 | |
| TC8 | Itc001 | celcr001 |
| TC9 | Itc001 | celcr001 |

| Test Thermocouple Correction Factors* | | |
|---------------------------------------|--------------|---------------|
| | SP1 950.0 °F | SP2 1200.0 °F |
| TC1 | 1.0 | 1.6 |
| TC2 | -0.9 | -2.2 |
| TC3 | -0.9 | -2.2 |
| TC4 | -0.9 | -2.2 |
| TC5 | -0.9 | -2.2 |
| TC6 | -0.9 | -2.2 |
| TC7 | -0.9 | -2.2 |
| TC8 | -0.9 | -2.2 |

Report Generated By AMS2750 TUS Report Tool All measured values (except the control TC) are corrected Page: 3 of 12

AMS2750 Report Generation Tool

Sample pages taken from a test TUS report.

Report Reference Number: 345

Customer: Heat Treatment Plant

Equipment: Furnace 1

| Test Thermocouple Correction Factors* | | |
|---------------------------------------|--------------|---------------|
| | SP1 950.0 °F | SP2 1200.0 °F |
| TC9 | -0.9 | -2.2 |

**Accuracy derived from TC Cal certs*

| Survey Recorder Correction Factors* | | |
|-------------------------------------|--------------|---------------|
| | SP1 950.0 °F | SP2 1200.0 °F |
| TC1 | 0.0 | 0.0 |
| TC2 | 0.0 | 0.0 |
| TC3 | 0.0 | 0.0 |
| TC4 | 0.0 | 0.0 |
| TC5 | -0.6 | -0.6 |
| TC6 | 0.0 | 0.0 |
| TC7 | 0.0 | 0.0 |
| TC8 | 0.0 | 0.0 |
| TC9 | 0.0 | 0.0 |

**Accuracy derived from Recorder Cal*

| Tus Offsets (As Found - As Left) | | |
|----------------------------------|----------|---------|
| | As Found | As Left |
| Tus Offsets | 5 | 20 |

AMS2750 Report Generation Tool

Sample pages taken from a test TUS report.

Report Reference Number: 345
 Customer: Heat Treatment Plant
 Equipment: Furnace 1

Thermocouple Furnace Position

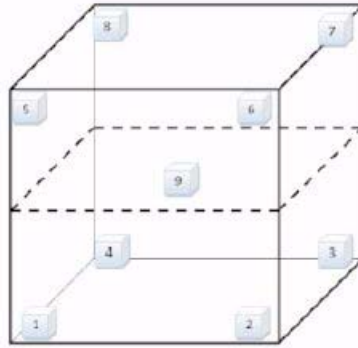

Qualified Work Area

| | | | |
|---------------|---|--------------------|-----|
| Width (x) ft | 6 | Volume Cubic ft | 240 |
| Height (y) ft | 5 | Notes | |
| Depth (z) ft | 8 | Using Only furnace | |
| TC1 | | | |
| TC2 | | | |
| TC3 | | | |
| TC4 | | | |
| TC5 | | | |
| TC6 | | | |
| TC7 | | | |
| TC8 | | | |
| TC9 | | | |

AMS2750 Report Generation Tool

Sample pages taken from a test TUS report.

Report Reference Number: 345
 Customer: Heat Treatment Plant
 Equipment: Furnace 1

Temperature Uniformity Survey Results

| Max & Min Thermocouple Temps During Measurement Period | | | | |
|--|--------------|---------|---------------|---------|
| | SP1 950.0 °F | | SP2 1200.0 °F | |
| | Min | Max | Min | Max |
| TC1 | 950.2 | 951.0 | 1200.1 | 1200.8 |
| TC2 | 949.8 | 950.2 | 1199.2 | 1199.6 |
| TC3 | 951.3 | 951.7 | 1202.6 | 1203.0 |
| TC4 | 951.3 | 951.9 | 1202.8 | 1203.1 |
| TC5 | 951.4 | 951.9 | 1202.7 | 1203.1 |
| TC6 | 952.1 | 952.6 | 1203.4 | 1203.8 |
| TC7 | 951.2 | 951.6 | 1202.6 | 1202.9 |
| TC8 | 951.0 | 951.4 | 1202.4 | 1202.8 |
| TC9 | 951.3 | 951.8 | 1202.6 | 1203.1 |
| Limit TC | TC 2 | TC 6 | TC 2 | TC 6 |
| Value | 949.8 | 952.6 | 1199.2 | 1203.8 |
| Uniformity | -0.2 °F | +2.6 °F | -0.8 °F | +3.8 °F |

All channels shown are corrected

AMS2750 Report Generation Tool

Sample pages taken from a test TUS report.

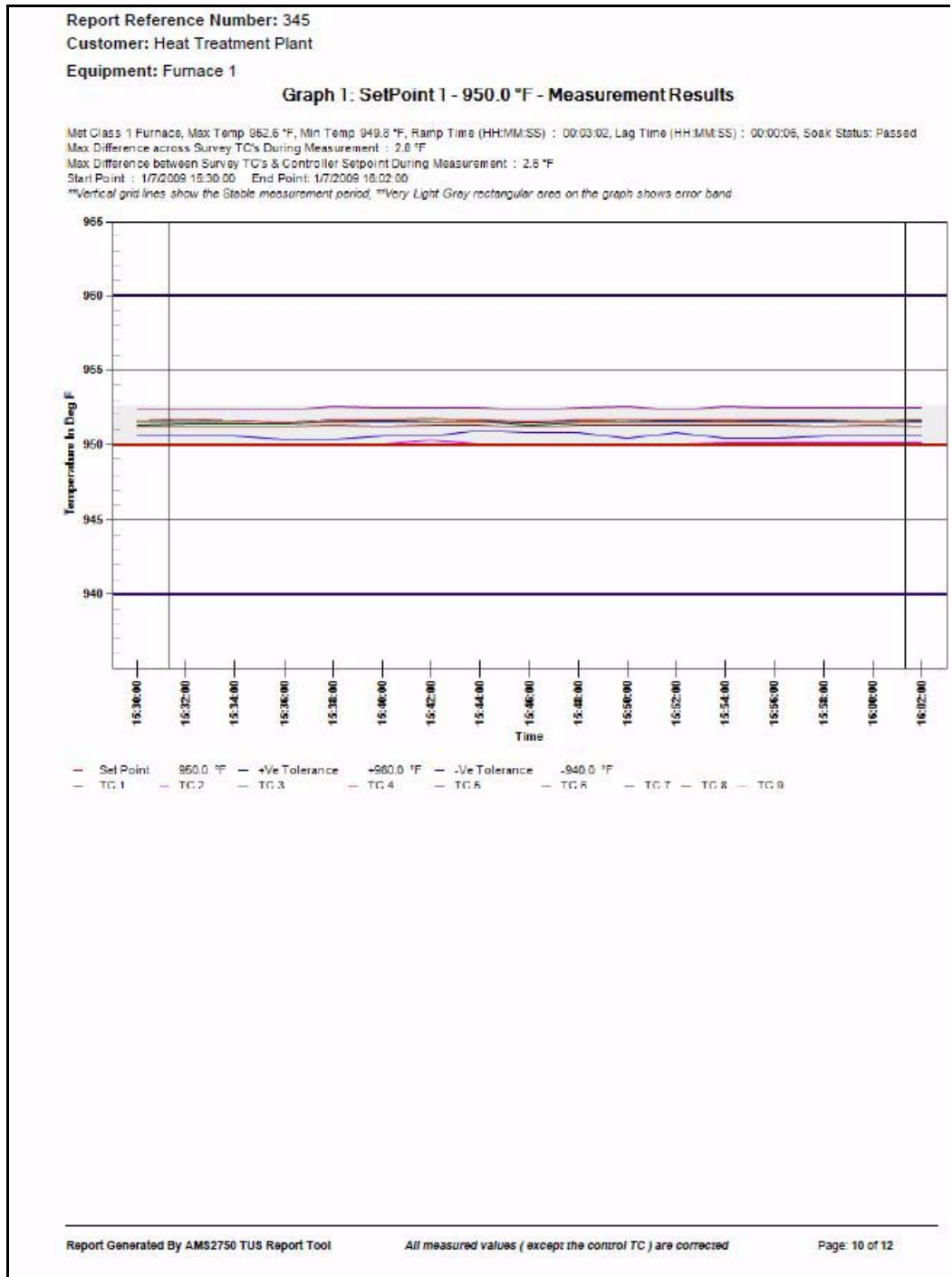

AMS2750 Report Generation Tool

Sample pages taken from a test TUS report

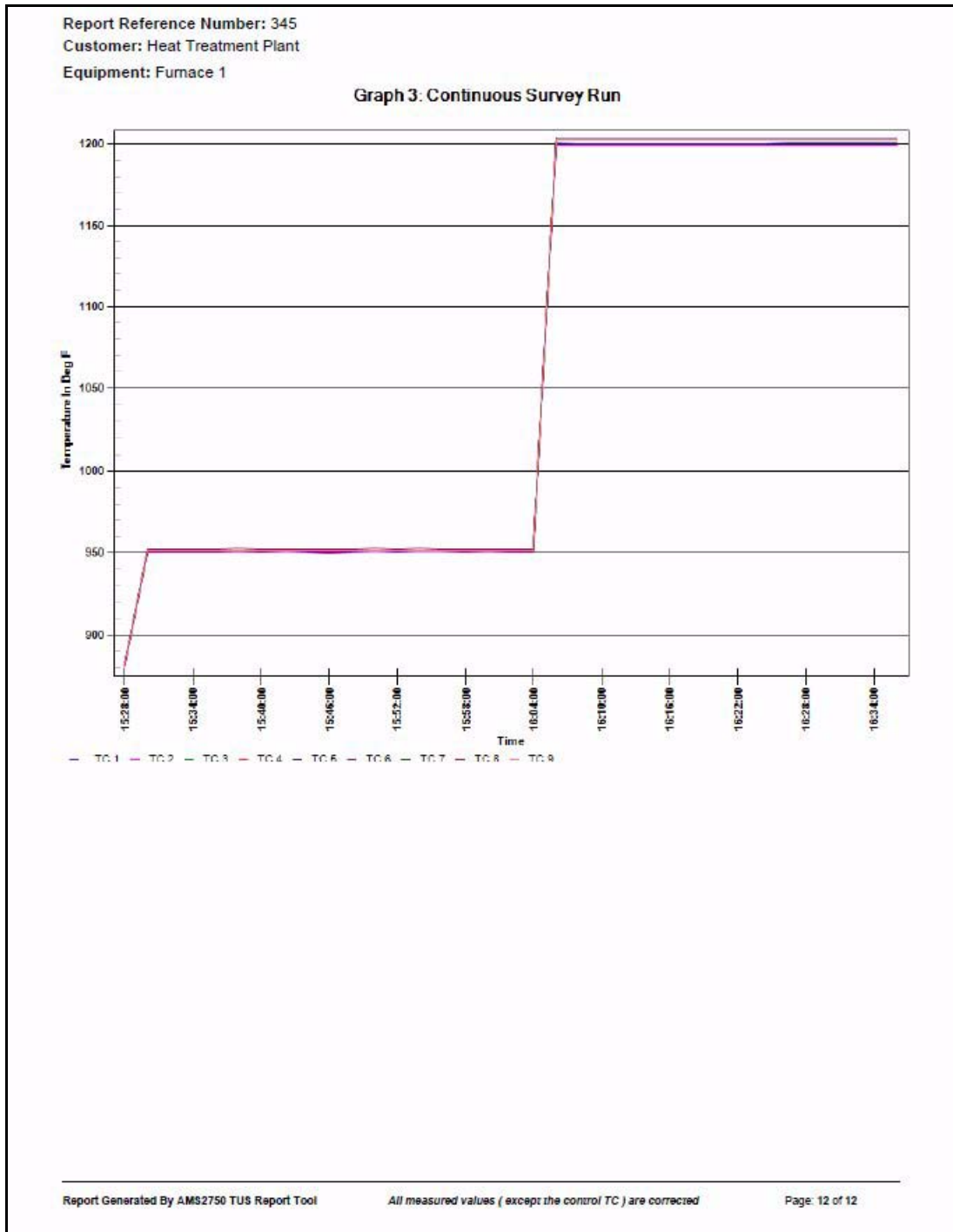

A

| | |
|--|--------|
| <i>AC Power</i> | 23 |
| <i>AI Calibration</i> | 132 |
| Factory Calibration | 132 |
| <i>AMS2750</i> | |
| Audit Trail | 417 |
| Events | 416 |
| Passwords | 419 |
| Screen Designer | 420 |
| TC Cal Adjust | 389 |
| TC Usage Tracking | 390 |
| TrendManager Pro Software | 420 |
| <i>AMS2750 (Process Mode)</i> | 385 |
| Countdown Timers (AMS2750) | 381 |
| Credit Option | 378 |
| Furnace Config. Menu | 385 |
| Info | 388 |
| Menu | 379 |
| Process Screen | 379 |
| Sensors Config. Menu | 386 |
| <i>AMS2750 (TUS Mode)</i> | 392 |
| Copy Cal. Adjust | 400 |
| Credit Option | 393 |
| Furnace Config. Menu | 396 |
| Info | 399 |
| Menu | 395 |
| Sensor Config. Menu | 399 |
| TUS Screen | 394 |
| <i>AMS2750 Capabilities</i> | 377 |
| <i>AMS2750 Process mode</i> | 378 |
| <i>AMS2750 Report Generation Tool</i> | 421 |
| <i>Acknowledge Alarm</i> | 175 |
| <i>Active X Control</i> | 277 |
| <i>Add Screen</i> | 159 |
| <i>Administrator, Passwords</i> | 165 |
| <i>Alarm</i> | |
| Event Causes | 115 |
| <i>Alarm Acknowledge</i> | |
| Event Effects | 122 |
| <i>Alarm Markers</i> | 236 |
| Alarm Marker Flash Colours | 236 |
| <i>Alarm Messages</i> | 187 |
| <i>Alarm Relay Card Connections</i> | 38 |
| 4 and 8 Alarm Relay Cards | 38 |
| Channel Numbers | 39 |
| <i>Alarm/Digital IO Diagnostics</i> | 202 |
| <i>Alarm/Digital IO Menu</i> | 77 |
| Alarm Relay Card | 77 |
| Digital IO Card | 77 |
| <i>Alarms Appendix D</i> | 341 |
| <i>Alarms Menu</i> | 175 |
| Acknowledge Alarm | 175 |
| Change Log Speed | 89 |
| Configure Alarms | 175 |
| Deviation | 88 |
| Email Alarm | 89 |
| High and Low | 88 |
| Mark Chart | 89 |
| Rate Up or Rate Down | 88 |
| View Alarms | 175 |
| <i>Alarms, Pens</i> | 88 |
| <i>All Messages</i> | 187 |
| <i>Analogue In Menu</i> | 73 |
| <i>Analogue Input Card</i> | 29, 30 |
| CJC Connectors | 32 |
| Channel Numbers | 30 |
| Connection Details | 30 |
| Current Input | 30 |
| Diagnostics | 201 |
| Signal Wiring | 31 |
| <i>Analogue Out Menu</i> | 76 |
| <i>Analogue Output Card</i> | 33 |
| Channel Numbers | 35 |
| Connection Details | 35 |
| Diagnostics | 202 |
| <i>Analogue Output Specifications</i> | 303 |
| <i>Appearance</i> | 161 |
| <i>Appendix A Quality and Safety</i> | 319 |
| <i>Appendix B Maths Expressions</i> | 321 |
| <i>Appendix C Thermocouple Connections</i> | 337 |
| <i>Appendix D Alarms</i> | 341 |
| <i>Appendix E Ethernet</i> | 343 |
| <i>Appendix F Fuzzy Logging</i> | 345 |
| <i>Appendix G F sub zero Sterilisation</i> | 349 |
| <i>Appendix H Calibration</i> | 351 |
| <i>Appendix I Battery Data</i> | 353 |
| <i>Appendix J</i> | |
| Function Codes and Memory Maps | 355 |
| <i>Appendix K Troubleshooting</i> | 363 |
| <i>Appendix L</i> | |
| AMS2750 Capabilities | 377 |
| <i>Audit Trail (AMS2750)</i> | 417 |

B

| | |
|--------------------------------------|-----|
| <i>Backlight Event Effects</i> | 123 |
| <i>Backlights</i> | 301 |
| <i>Barcodes for Batch</i> | 183 |
| <i>Batch</i> | |
| Event Causes | 115 |
| Event Effects | 125 |
| <i>Batch Commands</i> | 183 |
| <i>Batch Mark on Chart</i> | 182 |
| <i>Batch Menu</i> | 138 |
| Barcodes for Batch | 183 |
| Concurrent Batch Mode | 138 |
| <i>Batch Setup/Control</i> | 180 |
| Batch Commands | 183 |
| Batch Mark on Chart | 182 |
| <i>Batch process screens</i> | 140 |
| <i>Batch, Overview</i> | 53 |
| <i>Battery Data Appendix I</i> | 353 |
| <i>Battery Safety</i> | 353 |
| Processor Board | 353 |
| <i>Brightness</i> | |
| Screen Saver | 145 |

C

| | |
|---|-----|
| <i>CE Mark</i> | 319 |
| <i>CJC Calibration</i> | 135 |
| <i>CJC Connectors</i> | 32 |
| <i>Cables</i> | 22 |
| <i>Calibrate, Screen</i> | 179 |
| <i>Calibration</i> | 132 |
| AI Calibration | 132 |
| Appendix H | 351 |
| CJC Calibration | 135 |
| Maintenance | 302 |
| Sensor Compensation | 351 |
| User Calibration | 132 |
| <i>Calibration Input Range</i> | 134 |
| <i>Card Positions and Channel numbers</i> | 71 |
| <i>Card and Slot Positions</i> | 25 |
| <i>Change Chart Speed</i> | |
| Event Effects | 125 |
| <i>Change Log Speed, Alarms</i> | 89 |
| <i>Change Passwords</i> | 167 |
| <i>Channel Mapping</i> | |
| Map button | 177 |
| Parent Pens | 179 |
| <i>Channel Mapping Objects</i> | 178 |

| | |
|--|---------|
| <i>Channel Mapping Widgets</i> | 177 |
| <i>Characterisation Tables</i> | 81 |
| <i>Chart Control</i> | |
| Event Effects | 124 |
| <i>Chart Controls</i> | |
| Event | 272 |
| Realtime | 271 |
| <i>Chart Speeds</i> | 235 |
| <i>Charts</i> | 144 |
| <i>Clean Screen</i> | 179 |
| <i>Cleaning the Recorder</i> | 301 |
| <i>Clear All Messages</i> | |
| Event Effects | 124 |
| <i>Client/Server Network</i> | 109 |
| <i>Commit Configuration</i> | 206 |
| <i>Commit Later, Configuration</i> | 206 |
| <i>Comms</i> | |
| Data Logging and Transfer | 249 |
| Getting connected - IP Address | 248 |
| Hubs or Switches | 247 |
| Internet Security Settings | 277 |
| Local Area Network | 249 |
| Modbus Capabilities | 275 |
| PC Ethernet Connections | 247 |
| Protocols | 246 |
| Remote Networks | 249 |
| Remote Viewer | 276 |
| Software Installation | 253 |
| Standard Communications Interfaces | 245 |
| Web Browser | 276 |
| <i>Comms Connections</i> | 42 |
| <i>Comms Diagnostics</i> | 204 |
| FTP Status | 205 |
| Modbus Status | 204 |
| Peers Status | 205 |
| SMTP Status | 205 |
| <i>Comms Menu</i> | |
| DNS/WINS/MDNS | 96 |
| IP Address | 95 |
| IP Address Entry | 95 |
| Ports | 96, 101 |
| Services | 94 |
| TCP/IP | 94 |
| USB Comms Ports | 102 |
| <i>Comms Server</i> | 258 |
| Add Pens for Logging | 269 |
| Add a Database | 262 |
| Add a Database Server | 262 |
| Add a Device | 262 |
| Add a new Device | 259 |
| Administration | 259 |
| Client Connections | 270 |
| Comms Server Overview | 258 |
| Configure Database Logging | 259 |
| Connect to a Database | 262 |
| Connect to a Database Server | 259 |

| | |
|--|-----|
| Database | 258 |
| Database Logging | 270 |
| Delete a Database | 262 |
| Delete a Device | 266 |
| Diagnostics | 259 |
| Edit a Device | 266 |
| Logging Configuration | 268 |
| Network Settings | 259 |
| Preferences | 259 |
| Shutdown | 259 |
| Status Screen | 270 |
| Summary of Logging Changes | 269 |
| <i>Comms Server Database</i> | 274 |
| <i>Comms Server Overview</i> | 258 |
| <i>Comms Server Setup</i> | 261 |
| <i>Comms Server Start up</i> | 258 |
| <i>Comms Server Status Screen</i> | 270 |
| <i>Comms Services Menu</i> | 101 |
| Email | 106 |
| FTP | 109 |
| Modbus | 103 |
| Peers | 110 |
| SNTP | 108 |
| Web | 106 |
| <i>Comms, Overview</i> | 49 |
| <i>Communications Connections</i> | |
| Ethernet Connections | 42 |
| <i>Concurrent Batch Mode</i> | 138 |
| General Batch Properties | 138 |
| Group# Batch | 140 |
| <i>Configure Alarms</i> | 175 |
| <i>Configure Menu</i> | 67 |
| Edit Layout | 157 |
| Layout | 157 |
| Load Layout | 163 |
| Passwords | 164 |
| Save Layout | 162 |
| Setup Menu | 68 |
| <i>Control TC</i> | 400 |
| <i>Copy Cal. Adjust</i> | |
| AMS2750 (TUS Mode) | 400 |
| <i>Countdown Timers</i> | 381 |
| <i>Counters</i> | |
| Event Causes | 117 |
| Event Effects | 123 |
| <i>Counters - Process View and Reset</i> | 191 |
| <i>Counters Menu</i> | 126 |
| <i>Credits</i> | 131 |
| <i>Cursor</i> | 229 |
| <i>Custom Screens</i> | 239 |

D

| | |
|--|-----|
| <i>DC Input 24V</i> | 42 |
| <i>DC Power</i> | 23 |
| <i>DNS/WINS/MDNS</i> | 96 |
| <i>DR Graphic recorders Digital I/O card channel</i> | |
| <i>number mapping</i> | 41 |
| <i>DR Graphic recorders Digital I/O card slot</i> | |
| <i>position</i> | 41 |
| <i>DR Graphic recorders alarm card channel</i> | |
| <i>number mapping</i> | 39 |
| <i>DR Graphic recorders alarm card slot position</i> | 39 |
| <i>Data Logging and Transfer</i> | 249 |
| <i>Data Storage, Overview</i> | 49 |
| <i>Database Management Tool</i> | 280 |
| <i>Database Size Management</i> | 261 |
| <i>Daylight Saving</i> | 136 |
| <i>Default Time Zone</i> | 65 |
| <i>Delayed Event</i> | |
| Event Effects | 124 |
| <i>Delete Screen</i> | 159 |
| <i>Demo Traces</i> | 135 |
| <i>Deviation Alarm Markers</i> | 236 |
| <i>Deviation Alarms</i> | 88 |
| <i>Diagnostics</i> | |
| Alarm/Digital IO | 202 |
| Analogue In | 201 |
| Analogue Out | 202 |
| Comms | 204 |
| Comms Server | 259 |
| Event Status | 203 |
| Hardware Status | 201 |
| Media | 205 |
| Pulse Inputs | 203 |
| <i>Diagnostics Messages</i> | 187 |
| <i>Diagnostics Status</i> | 200 |
| <i>Digital IO Card Connections</i> | 38 |
| 8 and 16 Digital Input/Output Cards | 40 |
| Channel Numbers | 41 |
| <i>Digital Input</i> | |
| Event Causes | 115 |
| <i>Digital Outputs</i> | |
| Event Effects | 122 |
| <i>Dimensions</i> | 10 |
| <i>Discard Configuration</i> | 206 |
| <i>Display Alert</i> | |
| Event Effects | 125 |
| <i>Display, Overview</i> | 49 |
| <i>Displaying Totals</i> | 93 |
| <i>Dual Point Cal</i> | 351 |
| <i>During a Survey (AMS2750)</i> | 410 |

| | |
|---|-----|
| E | |
| <i>ESS - Extended Security System</i> | 208 |
| <i>Edit Custom Screens</i> | 176 |
| <i>Edit Layout</i> | 157 |
| Add Screen | 159 |
| Appearance | 161 |
| Delete Screen | 159 |
| Screens | 157 |
| Settings | 160 |
| <i>Edit Recording</i> | 148 |
| <i>Edit Recording Menu</i> | |
| Scheduled Export | 148 |
| Storage Alarm | 150 |
| Storage Bias | 149 |
| <i>Edit Screen Properties</i> | |
| Custom Screens | 176 |
| Standard Screens | 176 |
| <i>Edit Setup</i> | 69 |
| <i>Edit Standard Screens</i> | 176 |
| <i>Electrical Installation</i> | |
| 24V DC Input | 42 |
| AC Power | 23 |
| Alarm Relay Card Connections | 38 |
| Analogue Input Card | 29 |
| Analogue Output Card | 33 |
| Cables | 22 |
| Comms Connections | 42 |
| DC & AC Power | 23 |
| Digital IO Card Connections | 38 |
| Fuses | 22 |
| Installation Category | 22 |
| Pulse Input Card | 35 |
| SPNC Relay | 42 |
| Signal Wiring | 22 |
| Transmitter Power Supply Card | 37 |
| <i>Email</i> | 106 |
| Event Effects | 122 |
| <i>Email Alarm</i> | 89 |
| <i>Embedded Process Values</i> | 119 |
| Events Menu | 119 |
| <i>Enable Hot Button</i> | 160 |
| <i>Ending the Survey</i> | 416 |
| <i>Enter Replay Screen</i> | |
| Event Effects | 125 |
| <i>Error Alert</i> | 129 |
| <i>Error Messages</i> | 363 |
| <i>Ethernet</i> | |
| Connections | 42 |
| Rear Port | 101 |
| <i>Ethernet Appendix E</i> | 343 |
| <i>Event Causes</i> | 115 |
| AMS2750 Timer | 115 |
| Alarm | 115 |
| Batch | 115 |
| Counters | 117 |
| Digital Input | 115 |
| Hot Button | 115 |
| Max Mins (Reset) | 115 |
| Scheduled Event Causes | 116 |
| System | 115 |
| TC Burn Out | 115 |
| TUS Start | 115 |
| TUS Stop | 115 |
| Totaliser | 115 |
| User Action | 115 |
| <i>Event Chart Controls</i> | 272 |
| <i>Event Effects</i> | 119 |
| Alarm Acknowledge | 122 |
| Backlight | 123 |
| Batch | 125 |
| Change Chart Speed | 125 |
| Chart Control | 124 |
| Clear All Messages | 124 |
| Counters | 123 |
| Delayed Event | 124 |
| Digital Outputs | 122 |
| Display Alert | 125 |
| Email | 122 |
| Embedded Process Values | 119 |
| Enter Replay Screen | 125 |
| Exit Replay Screen | 125 |
| Logging | 122 |
| Mark on Chart | 119 |
| Max Mins Reset | 124 |
| Play Sound | 125 |
| Preset Markers | 127 |
| Print Screen | 123 |
| Reports | 125 |
| Screen Change | 123 |
| Script Timers | 124 |
| Time Sync | 127 |
| Totaliser | 122 |
| Update Tabular Readings | 125 |
| <i>Event Status</i> | |
| Diagnostics | 203 |
| <i>Event triggering from Scripts</i> | 125 |
| <i>Events (AMS2750)</i> | 416 |
| <i>Events Menu</i> | 111 |
| Event Causes | 115 |
| Event Effects | 119 |
| <i>Events, Overview</i> | 53 |
| <i>Events/Counters</i> | 111 |
| <i>Exit Replay Screen</i> | |
| Event Effects | 125 |
| <i>Export Format</i> | |
| File Type | 152 |
| <i>Export Now</i> | 185 |
| Network Share folder (NAS) | 185 |
| <i>Extra Pens</i> | 242 |

F

| | |
|--|-----|
| <i>F sub 0, Totaliser</i> | 90 |
| <i>F sub zero Sterilisation Appendix G</i> | 349 |
| <i>FTP</i> | 109 |
| <i>FTP Status</i> | 205 |
| <i>Factory Calibration</i> | 132 |
| <i>Factory Menu</i> | 131 |
| AI Calibration | 132 |
| CJC Calibration | 135 |
| Calibration | 132 |
| Credits | 131 |
| Daylight Saving | 136 |
| Firmware Upgrade | 132 |
| Language | 136 |
| Localisation | 136 |
| Media Config | 137 |
| Temp.Units | 136 |
| Time Zone | 136 |
| <i>Field IO Menu</i> | 70 |
| Alarm Relay | 77 |
| Alarm/Digital IO | 77 |
| Analogue In Menu | 73 |
| Analogue Out | 76 |
| Digital IO | 77 |
| Pulse Input | 80 |
| <i>Field IO Specification</i> | 303 |
| Analogue Output | 303 |
| Pulse Input Card | 303 |
| <i>Finish</i> | |
| Commit | 206 |
| Commit Later | 206 |
| Discard | 206 |
| <i>Finish button</i> | 206 |
| <i>Firmware Credit System</i> | 241 |
| <i>Firmware Options</i> | 243 |
| <i>Firmware Upgrade</i> | 132 |
| <i>First Time Password Setup - ESS</i> | 208 |
| <i>Full Maths</i> | 330 |
| <i>Full Maths & Script Processing</i> | 321 |
| <i>Function Codes and Memory Maps</i> | 355 |
| <i>Functions and Features, Overview</i> | 45 |
| <i>Furnace Config. Menu (Process Mode)</i> | 385 |
| <i>Furnace Config. Menu (TUS)</i> | 396 |
| <i>Fuses</i> | 22 |
| <i>Fuzzy Logging Appendix F</i> | 345 |

G

| | |
|---|-----|
| <i>General Batch Properties</i> | 138 |
| <i>General Menu</i> | 128 |
| Batch Menu | 138 |
| Error Alert | 129 |
| Factory | 131 |
| Groups | 142 |
| Identity | 128 |
| Printer Menu | 141 |
| <i>Getting connected - IP Address</i> | 248 |
| <i>Group# Batch</i> | 140 |
| <i>Groups</i> | 142 |

H

| | |
|---|----------|
| <i>Hardware Configuration Lock</i> | 224 |
| <i>Hardware Lock</i> | 242 |
| <i>Hardware Options, Overview</i> | 55 |
| <i>Hardware Status</i> | |
| Diagnostics | 201 |
| <i>Hazardous Voltages</i> | 4 |
| <i>Header and Footer report information</i> | 440 |
| <i>Help Files</i> | 66 |
| <i>High and Low Alarms</i> | 88 |
| <i>Hot Button</i> | 160, 235 |
| Enable | 160 |
| Event Cause | 115 |
| User Action | 115 |
| <i>Hubs or Switches</i> | 247 |

I

| | |
|---|-----|
| <i>I/O + AMS2750 (TUS)</i> | 394 |
| <i>I/O + AMS2750 Process Mode</i> | 383 |
| <i>IP Address</i> | 95 |
| <i>IP Address Entry</i> | 95 |
| <i>IP Address Troubleshooting</i> | 276 |
| <i>Identity</i> | 128 |
| <i>Installation</i> | 7 |
| 24V DC Input | 42 |
| Alarm Relay Cards | 38 |
| Analogue Input Card | 29 |
| Analogue Output Card | 33 |
| Comms Connections | 42 |

| | |
|---|-----|
| Digital IO Cards | 38 |
| Environment and Location | 7 |
| Mechanical Installation | 8 |
| Panel cut-out size | 8 |
| Pulse Input Card | 35 |
| SPNC Relay | 42 |
| Transmitter Power Supply Card | 37 |
| <i>Installation Category</i> | 22 |
| <i>Internal SD Memory</i> | 150 |
| <i>Internet Security Settings</i> | 277 |

J

| | |
|---------------------------|-----|
| <i>Jump feature</i> | 188 |
|---------------------------|-----|

K

| | |
|------------------------|----|
| <i>Keyboards</i> | 44 |
|------------------------|----|

L

| | |
|--------------------------------|-----|
| <i>LED Flash Codes</i> | 317 |
| <i>Language</i> | 136 |
| <i>Layout Menu</i> | 157 |
| Add Screen | 159 |
| Appearance | 161 |
| Delete Screen | 159 |
| Edit Layout | 157 |
| Edit Settings | 160 |
| Load Layout | 163 |
| Save Layout | 162 |
| Screens | 157 |
| <i>Layout Settings</i> | 160 |
| <i>Level</i> | |
| Permissions Table | 211 |
| <i>Levels</i> | |
| Passwords | 166 |
| <i>Linearisation Tables</i> | |
| Analogue Input | 81 |
| <i>Load Certificates</i> | 100 |
| <i>Load Layout</i> | 163 |
| <i>Load Setup</i> | 68 |
| <i>Load layout</i> | |
| NAS | 163 |
| <i>Local Area Network</i> | |
| Comms | 249 |

| | |
|-----------------------------|-----|
| <i>Local Settings</i> | 65 |
| Default Time Zone | 65 |
| <i>Localisation</i> | 136 |
| Daylight Saving | 136 |
| Language | 136 |
| Line Hz | 136 |
| Temp.Units | 136 |
| Time Zone | 136 |
| <i>Log On/Off</i> | 64 |
| <i>Logging</i> | 86 |
| Event Effects | 122 |
| <i>Look-up Tables</i> | 81 |

M

| | |
|---|---------------|
| <i>Main Menu</i> | 66 |
| Alarms Menu | 175 |
| Batch Commands | 183 |
| Batch Mark on Chart | 182 |
| Batch Setup/Control | 180 |
| Configure | 67 |
| Layout | 157 |
| Messages Menu | 187 |
| Passwords | 164 |
| Process Menu | 190 |
| Recording Menu | 184 |
| Screen Menu | 176 |
| Setup Menu | 68 |
| Status Menu | 194 |
| <i>Main Menu Access</i> | 63 |
| <i>Maintenance</i> | |
| Backlights | 301 |
| Calibration | 302 |
| Cleaning | 301 |
| Operating Temperature | 301 |
| Touch Screen | 302 |
| <i>Maintenance Status</i> | 198 |
| <i>Map button</i> | 177 |
| <i>Mark Chart, Alarms</i> | 89 |
| <i>Mark on Chart</i> | 119, 226, 237 |
| Event Effects | 119 |
| <i>Maths Credit Options</i> | 321 |
| <i>Maths Error Messages</i> | 336 |
| <i>Maths Expressions</i> | 321 |
| Full Maths | 330 |
| Full Maths & Script Processing | 321 |
| Maths Variable and Function Tables | 322 |
| Script Function Application Examples | 331 |
| <i>Maths Variable and Function Tables</i> | 322 |
| <i>Max Mins (Reset) Event Causes</i> | 115 |
| <i>Max Mins Reset</i> | |
| Event Effects | 124 |
| <i>Max/Min Reset</i> | 190 |

| | |
|--|----------|
| <i>Mechanical Installation</i> | 8 |
| Dimensions | 10 |
| Installation Instructions | 11 |
| Mounting and Viewing Angles | 8 |
| Panel Mounting | 13 |
| Panel Mounting Clamp Installation | 13 |
| Panel cut-out size | 8 |
| <i>Media Config</i> | 137 |
| <i>Media Diagnostics</i> | 205 |
| <i>Memory Maps and Function Codes</i> | 355 |
| <i>Menu Bar</i> | 226 |
| Screen | 228 |
| <i>Menu Path</i> | 65 |
| <i>Message Format</i> | 189 |
| <i>Message List</i> | 188 |
| Jump | 188 |
| <i>Message Types</i> | 187 |
| Alarms | 187 |
| All | 187 |
| Diagnostics | 187 |
| Security | 187 |
| System | 187 |
| User | 187 |
| <i>Message list printing</i> | 188 |
| <i>Messages Menu</i> | 187 |
| Alarm Messages | 187 |
| All Messages | 187 |
| Diagnostics Messages | 187 |
| Message Types | 187 |
| Messages Format | 189 |
| Messages List | 188 |
| Security Messages | 187 |
| System Messages | 187 |
| User Messages | 187 |
| <i>Messages Screen printing</i> | 187 |
| <i>Minitrend QX Rear Connections</i> | 59 |
| <i>Minitrend QX Standard Screens</i> | 57 |
| <i>Minitrend QX and QXe Portable Case</i> | 284, 294 |
| <i>Modbus</i> | 103 |
| <i>Modbus Capabilities</i> | 275 |
| <i>Modbus Function Codes</i> | 362 |
| <i>Modbus Status</i> | 204 |
| <i>Modbus profile tool, data update</i> | 265 |
| <i>Modbus, Comms</i> | 246 |
| <i>Mounting Clamp Diagram for 45mm panel thickness</i> | 17 |
| <i>Mounting and Viewing Angles</i> | 8 |
| <i>Multi Point Cal</i> | 352 |
| <i>Multitrend SX Portable Case</i> | 290 |
| <i>Multitrend SX Rear Connections</i> | 61 |
| <i>Multitrend SX Standard Screens</i> Overview | 56 |

N

| | |
|---------------------------------------|-----|
| <i>NAS</i> | |
| Export Now | 185 |
| Save or Load Layout | 163 |
| Share Path | 98 |
| <i>NAS Button</i> | |
| Device Selection | 162 |
| <i>Network Settings</i> | |
| Comms Server | 259 |
| <i>Network Share Path (NAS)</i> | 98 |

O

| | |
|--------------------------------------|-----|
| <i>Operating Temperature</i> | 301 |
| <i>Options</i> | 196 |
| <i>Overview</i> | 45 |
| Batch | 53 |
| Comms | 49 |
| Data Storage | 49 |
| Display | 49 |
| Events | 53 |
| Functions and Features | 45 |
| Minitrend QX Rear Connections | 59 |
| Minitrend QX Standard Screens | 57 |
| Multitrend SX Rear Connections | 61 |
| Multitrend SX Standard Screens | 56 |
| Options - Hardware | 55 |
| QX Rear Connections | 59 |
| QX Standard Screens | 57 |
| QXe Rear Connections | 60 |
| Recorder Functionality | 47 |
| Remote Control Viewer | 52 |
| SX Rear Connections | 61 |
| SX Standard Screens | 56 |
| Security | 52 |
| USB Devices | 50 |
| eZtrend QX Rear Connections | 60 |
| eZtrend QXe Standard Screens | 58 |

P

| | |
|---|-----|
| <i>PC Ethernet Connections</i> | 247 |
| <i>Panel Mounting</i> | 13 |
| <i>Panel cut-out size</i> | 8 |
| <i>Password Net Sync</i> | |
| Configuration | 170 |
| Rules | 168 |
| <i>Password NetSync</i> | 168 |
| <i>Password Network Synchronisation</i> | 168 |
| <i>Password Policy</i> | 210 |

| | |
|---|-----|
| <i>Password Security</i> | 207 |
| Audit Trail | 210 |
| ESS | 208 |
| First Time Password Setup - ESS | 208 |
| Level Permissions Table | 211 |
| Log On/Off | 207 |
| Users and Groups | 207 |
| <i>Passwords</i> | 164 |
| Add User | 166 |
| Administrator | 165 |
| Change Passwords | 167 |
| Delete User | 167 |
| First Time Login | 164 |
| Levels | 166 |
| Policy | 165 |
| Reset Passwords | 167 |
| User Administration | 165 |
| Users | 167 |
| <i>Passwords (AMS2750)</i> | 419 |
| <i>Passwords Setup First time ESS</i> | 208 |
| <i>Peers</i> | 110 |
| <i>Peers Status</i> | 205 |
| <i>Pen Overview Status</i> | 197 |
| <i>Pen Pointers</i> | 236 |
| <i>Pen Report Information</i> | 155 |
| <i>Pens Menu</i> | 84 |
| Alarms | 88 |
| Logging | 86 |
| Scale | 85 |
| Totaliser | 90 |
| <i>Pens for TC's (Process Mode)</i> | 389 |
| <i>Play Sound</i> | |
| Event Effects | 125 |
| <i>Policy, Passwords</i> | 165 |
| <i>Ports, Comms</i> | 96 |
| <i>Ports, Ethernet</i> | 101 |
| <i>Post-Trigger</i> | |
| Set Post-Trigger time | 151 |
| <i>Power up</i> | 63 |
| <i>Pre-Trigger</i> | 151 |
| Acquiring | 151 |
| Alarm Rate | 87 |
| Configuration | 151 |
| Enable | 87 |
| Event processing | 151 |
| Export | 151 |
| Importing | 152 |
| Logging Type | 87 |
| Post-Trigger | 151 |
| Restart | 152 |
| Set Pre-Trigger time | 151 |
| <i>Preface</i> | 1 |
| <i>Preset Markers</i> | 127 |
| <i>Print Screen Event Effects</i> | 123 |
| <i>Print Support</i> | 44 |
| <i>Printer Menu</i> | 141 |

| | |
|--------------------------------------|---------|
| <i>Printing</i> | |
| Message List | 188 |
| Messages Screens | 187 |
| Status Screens | |
| <i>Status Screen printing</i> | 195 |
| <i>Process Menu</i> | 190 |
| Counters - View and Reset | 191 |
| Max/Min | 190 |
| Reports | 192 |
| Script Timers | 192 |
| Totals - Start, Stop, Reset | 190 |
| User Variables | 192 |
| <i>Process Mode (AMS2750)</i> | 385 |
| <i>Process Screen Overview</i> | 225 |
| <i>Processor Board</i> | |
| Battery Safety | 353 |
| <i>Protocols</i> | 3, 246 |
| <i>Pulse Input Card</i> | 35, 303 |
| Channel Numbers | 36 |
| Connection Details | 36 |
| Diagnostics | 203 |
| <i>Pulse Input Menu</i> | 80 |

Q

| | |
|--|----------|
| <i>QX Rear Connections</i> | 59 |
| <i>QX Standard Screens</i> | 57 |
| <i>QX and QXe Portable Case</i> | 284, 294 |
| <i>QXe Rear Connections</i> | 60 |
| <i>Quality and Safety</i> | |
| CE Mark | 319 |
| Safety | 319 |
| <i>Quality and Safety Appendix A</i> | 319 |

R

| | |
|---|-----|
| <i>RS485 Minitrend GR2, and Multitrend GR3 and DR Graphic recorders</i> | 42 |
| <i>Rate Up or Rate Down Alarms</i> | 88 |
| <i>Re-Start Recorder</i> | 64 |
| <i>Realtime Chart Controls</i> | 271 |
| <i>Recorder Functionality, Overview</i> | 47 |
| <i>Recorder Setup</i> | 63 |
| Default Time Zone | 65 |
| Local Settings | 65 |
| LogOn/Off | 64 |
| Main Menu | 66 |
| Main Menu Access | 63 |
| Menu Path | 65 |

| | |
|--|----------|
| <i>Recording Menu</i> | 184 |
| Device Selection | 186 |
| Export Now | 185 |
| Export “busy” light | 186 |
| Recording Methodology | 184 |
| <i>Recording Methodology</i> | 184 |
| <i>Recording Status</i> | 199 |
| <i>Relay Alarm/Digital Input Specification</i> | 304 |
| <i>Remote Control Viewer, Overview</i> | 52 |
| <i>Remote Networks</i> | |
| Comms | 249 |
| <i>Remote Viewer</i> | 276 |
| <i>Replay</i> | 179, 228 |
| Cursor | 229 |
| <i>Report Generation Tool - AMS2750D</i> | 280 |
| <i>Report Tool</i> | 421 |
| Installation | 421 |
| Introduction | 423 |
| Overview | 421 |
| PDF support | 422 |
| SAT Report Wizard | 425 |
| SAT Report example | 427 |
| TUS Report - Example | 441 |
| TUS Report Wizard | 428 |
| User Interface | 423 |
| <i>Reports</i> | |
| Event Effects | 125 |
| Pen Report Information | 155 |
| Process Menu | 192 |
| Reset All | 193 |
| Run | 192 |
| View Archive | 193 |
| <i>Reports Menu</i> | 153 |
| <i>Reset</i> | |
| Setup, Layout, Data, All | 136 |
| <i>Reset Passwords</i> | 167 |
| <i>Reset at 16M</i> | |
| Totalisers | 92 |
| <i>Resistance Thermometers</i> | 30 |

S

| | |
|---|-----|
| <i>SAT Report Wizard</i> | 425 |
| <i>SD CARD</i> | 50 |
| <i>SD CARD Handling precautions</i> | 51 |
| <i>SD CardFormat</i> | 184 |
| <i>SD card</i> | 150 |
| <i>SMTP Status</i> | 205 |
| <i>SNTP</i> | 108 |
| Client / Server Network | 109 |
| <i>SX Rear Connections</i> | 61 |
| <i>SX Standard Screens</i> | |
| Overview | 56 |

| | |
|---|----------|
| <i>Safety</i> | 2, 319 |
| Battery Data | 353 |
| Hazardous Voltage | 4 |
| Static Electricity | 3 |
| Symbols | 2 |
| <i>Safety and Symbol Identification</i> | 3 |
| <i>Save Layout</i> | 162 |
| NAS | 163 |
| <i>Save Setup</i> | 68 |
| <i>Saving Message Screens</i> | 188 |
| <i>Saving Status Screens</i> | 194 |
| <i>Scale Menu</i> | 85 |
| <i>Scheduled Events</i> | |
| Event Causes | 116 |
| <i>Scheduled Export</i> | 148 |
| <i>Screen Activity</i> | |
| Alarm Markers | 236 |
| Charts Speeds | 235 |
| Deviation Alarm Markers | 236 |
| Mark on Chart | 237 |
| Pen Pointers | 236 |
| Screen Markers | 238 |
| <i>Screen Change Event Effects</i> | 123 |
| <i>Screen Configuration</i> | 225 |
| Menu Bar | 226 |
| Process Screen Overview | 225 |
| Screen Designer Screens | 239 |
| Screen Menu Bar | 227 |
| <i>Screen Designer</i> | 239 |
| Loading a Layout into a Recorder | 239 |
| Loading a Template into a Recorder | 239 |
| Software | 279 |
| <i>Screen Designer (AMS2750)</i> | 420 |
| <i>Screen List</i> | 179 |
| <i>Screen Markers</i> | 238 |
| <i>Screen Menu</i> | 143, 176 |
| Calibrate | 179 |
| Charts | 144 |
| Clean Screen | 179 |
| Replay | 179 |
| Screen List | 179 |
| Screen Saver | 143 |
| Tabular Display | 146 |
| Touch Test | 179 |
| <i>Screen Menu Bar</i> | 227 |
| Edit Screen Properties | 176 |
| Replay | 228 |
| <i>Screen Saver</i> | 143 |
| Brightness | 145 |
| Dim Saver | 144 |
| <i>Screens</i> | 157 |
| Tabular Screen | 146 |
| <i>Script Function Application Examples</i> | 331 |
| <i>Script Timers</i> | |
| Event Effects | 124 |
| Process Menu | 192 |
| <i>Scripts, Trigger Events</i> | 125 |
| <i>Secure Comms</i> | 242 |

| | | | |
|--|----------|---|----------|
| <i>Secure Communications</i> | 100 | Logging | 86 |
| Secure FTP | 100 | Modbus | 103 |
| WSD | 100 | Peers | 110 |
| <i>Secure FTP</i> | 100 | Pens | 84 |
| <i>Secure FTP for Trend Server</i> | 254 | Printer Menu | 141 |
| <i>Security</i> | 207 | Pulse Input | 80 |
| <i>Security Messages</i> | 187 | Reports | 153 |
| <i>Security, Overview</i> | 52 | SNTP | 108 |
| <i>Send Recorder Events</i> | 259 | Save Setup | 68 |
| Chart Controls | 271 | Scale Menu | 85 |
| <i>Sensor Compensation</i> | | Screen Saver | 143 |
| Analogue Input Calibration | 351 | Screen Setup | 143 |
| Dual Point Cal | 351 | Services | 94 |
| Multi Point Cal | 352 | TCP/IP | 94 |
| Single Point Cal | 351 | Tabular Display | 146 |
| <i>Sensor Config. Menu (TUS)</i> | 399 | Temp.Units | 136 |
| <i>Sensors Config. Menu (Process Mode)</i> | 386 | Time Zone | 136 |
| <i>Server Name, Email</i> | 106 | Totaliser | 90 |
| <i>Server Name, SNTP</i> | 108 | Web Enable | 106 |
| <i>Services</i> | 94 | <i>Share Path (NAS)</i> | 98 |
| <i>Settings</i> | 173 | <i>Signal Wiring</i> | 22 |
| Thermocouple Adjustment Factor, Disable | 174 | <i>Single Point Cal</i> | 351 |
| Time & Date | 173 | <i>Slave ID</i> | 105 |
| Volume, Sound Effects | 173 | <i>Software</i> | 279 |
| <i>Settings Update Sounds, Sound Effects</i> | 173 | <i>Software Installation, Comms</i> | 253 |
| <i>Setup Menu</i> | 68 | <i>Sound Effects</i> | |
| AI Calibration | 132 | Set Volume | 173 |
| Alarm Relay | 77 | Update Sounds | 173 |
| Alarm/Digital IO | 77 | <i>Spares List</i> | 281 |
| Alarms Menu | 88 | Minitrend QX | 281, 295 |
| Analogue In Menu | 73 | Minitrend QX and QXe Portable Case | 284, 294 |
| Analogue Out | 76 | Multitrend SX | 285 |
| Batch Menu | 138 | Multitrend SX Portable Case | 290 |
| CJC Calibration | 135 | QX and QXe Portable Case | 284, 294 |
| Calibration | 132 | eZtrend QXe | 291 |
| Charts | 144 | <i>Specification Tables</i> | 307 |
| Comms Services | 101 | <i>Specifications</i> | 303 |
| Counters | 126 | <i>Standard Communications Interfaces</i> | 245 |
| Credits | 131 | <i>Start Up</i> | 254 |
| Daylight Saving | 136 | <i>Start a Survey (AMS2750)</i> | 410 |
| Digital IO | 77 | <i>Static Electricity, Safety</i> | 3 |
| Edit Recording | 148 | <i>Status Menu</i> | 194 |
| Edit Setup | 69 | Alarm/Digital IO | 202 |
| Email | 106 | Analogue In | 201 |
| Error Alert | 129 | Analogue Out | 202 |
| Events Menu | 111 | Comms | 204 |
| Events/Counters Menu | 111 | Diagnostics | 200 |
| FTP | 109 | Event Status | 203 |
| Factory | 131 | General Status | 195 |
| Field IO | 70 | Hardware Status | 201 |
| Firmware Upgrade | 132 | IO Cards | 197 |
| General | 128 | Maintenance | 198 |
| Groups | 142 | Media | 205 |
| IP Address | 95 | Options | 196 |
| Identity | 128 | Pen Overview | 197 |
| Language | 136 | Pulse Inputs | 203 |
| Load Menu | 68 | Recording | 199 |
| Localisation | 136, 137 | System | 195 |

| | |
|--|-----|
| <i>Sterilisation</i> | 93 |
| <i>Storage Alarm</i> | 150 |
| <i>Storage Bias</i> | 149 |
| <i>Storage Media Format</i> | 184 |
| <i>Stylus</i> | 63 |
| <i>Survey Status (AMS2750)</i> | 410 |
| <i>Symbols, Safety</i> | 2 |
| <i>System</i> | |
| Event Causes | 115 |
| <i>System Accuracy Tests (SAT)</i> | 383 |
| <i>System Menu</i> | |
| General Status | 195 |
| IO Cards | 197 |
| Options | 196 |
| <i>System Messages</i> | 187 |
| <i>System Requirements</i> | 252 |
| <i>System, Status</i> | 195 |

T

| | |
|--|---------------|
| <i>TC Burn Out, Event Causes</i> | 115 |
| <i>TC Cal. Adjust (AMS2750)</i> | 389 |
| <i>TC Usage Tracking (AMS2750)</i> | 390 |
| <i>TCP/IP</i> | 94 |
| DNS/WINS/MDNS | 96 |
| IP Address | 95 |
| Ports | 96 |
| <i>TUS Data file</i> | 417 |
| <i>TUS Logged data</i> | 418 |
| <i>TUS Mode (AMS2750)</i> | 392 |
| <i>TUS Report Wizard</i> | 428 |
| <i>TUS Start</i> | |
| Event Causes | 115 |
| <i>TUS Stop</i> | |
| Event Causes | 115 |
| <i>TUS survey process screen</i> | 402 |
| <i>Tabular Display</i> | 146 |
| <i>Tabular Screen</i> | 146 |
| <i>Technical Data & Specifications</i> | 303 |
| Analogue Output | 303 |
| Field IO | 303 |
| Input Range Performance Accuracy Table | 312 |
| Pulse Input Card | 303 |
| Relay Alarm/Digital Input | 304 |
| Specification Tables | 307 |
| <i>Temp.Units</i> | 136 |
| <i>Temperature Uniformity Survey (TUS)</i> | 392 |
| During a Survey | 410 |
| Ending the Survey | 416 |
| Start a Survey | 410 |
| Survey status | 410, 414, 415 |
| <i>Detect Mode</i> | 411 |
| <i>Soak Mode</i> | 412 |
| <i>Stable (in soak) Mode</i> | 413 |
| <i>TC Stabilized</i> | 412 |
| <i>Temperature overshoot</i> | 411 |

| | |
|--|-----|
| TUS Logged data | 418 |
| <i>Thermocouple Adjustment Factor, Disable</i> 174 | |
| <i>Thermocouple Connections</i> | |
| External Reference | 339 |
| How Thermocouples work | 337 |
| Internal Reference | 338 |
| Thermocouple CJC Compensation | 338 |
| <i>Thermocouple Connections Appendix C</i> . | 337 |
| <i>Time & Date</i> | |
| Settings | 173 |
| <i>Time Sync</i> | 127 |
| <i>Time Zone</i> | 136 |
| <i>Timer (AMS2750)</i> | |
| Event Causes | 115 |
| <i>Totaliser</i> | 90 |
| Displaying Totals | 93 |
| Event Causes | 115 |
| Event Effects | 122 |
| F sub 0 | 90 |
| Sterilisation | 93 |
| <i>Totals - Start, Stop, Reset</i> | 190 |
| <i>Touch Screen</i> | 302 |
| <i>Touch Test</i> | 179 |
| <i>Trademarks</i> | 1 |
| <i>Transmitter Power Supply Card</i> | 37 |
| <i>TrendManager Pro Software</i> | 279 |
| (AMS2750) | 420 |
| TrendManager Pro | 279 |
| TrendServer Pro | 279 |
| TrendViewer | 279 |
| <i>Troubleshooting</i> | |
| Error Messages | 363 |

U

| | |
|---|-----|
| <i>USB Comms Ports</i> | 102 |
| <i>USB Devices</i> | 44 |
| Keyboards | 44 |
| Print Support | 44 |
| USB Keys | 44 |
| <i>USB Devices, Overview</i> | 50 |
| <i>USB Key Format</i> | 184 |
| <i>USB Keys</i> | 44 |
| <i>Update Tabular Readings</i> | |
| Event Effects | 125 |
| <i>User Action</i> | |
| Event Causes | 115 |
| Hot Button | 115 |
| <i>User Calibration</i> | 132 |
| <i>User Counters, Event Cause</i> | 117 |
| <i>User Messages</i> | 187 |
| <i>User Variables</i> | |
| Process Menu | 192 |
| <i>Users, Passwords</i> | 167 |



V,W,X,Y,Z

| | |
|--|-----|
| <i>View Alarms</i> | 175 |
| <i>WSD (Web Services on Devices)</i> | 100 |
| <i>Warnings and Precautions</i> | 3 |
| <i>Web Browser</i> | 276 |
| Auto DNS | 94 |
| <i>Web Enable</i> | 106 |
| <i>Zoom In</i> | 229 |
| <i>Zoom Out</i> | 230 |
| <i>Zooming</i> | 232 |
| <i>Zooming Capabilities</i> | 233 |
| <i>xs-nnnnnn, Auto DNS</i> | 94 |

Sales and Service

For application assistance, current specifications, pricing, or name of the nearest Authorized Distributor, contact one of the offices below.

ASIA PACIFIC

Honeywell Process Solutions,
(TAC)
dfs-tac-support@honeywell.com

Australia
Honeywell Limited
Phone: +(61) 7-3846 1255
FAX: +(61) 7-3840 6481
Toll Free 1300-36-39-36
Toll Free Fax:
1300-36-04-70

China – PRC - Shanghai
Honeywell China Inc.
Phone: (86-21) 5257-4568
Fax: (86-21) 6237-2826

Singapore
Honeywell Pte Ltd.
Phone: +(65) 6580 3278
Fax: +(65) 6445-3033

South Korea
Honeywell Korea Co Ltd
Phone: +(822) 799 6114
Fax: +(822) 792 9015

EMEA

Honeywell Process Solutions,
Phone: + 80012026455 or
+44 (0)1344 656000

Email: (Sales)
FP-Sales-Apps@Honeywell.com
or
(TAC)
dfs-tac-support@honeywell.com

AMERICA's

Honeywell Process Solutions,
Phone: 1-800-423-9883
Or 215/641-3610
(Sales) 1-800-343-0228

Email: (Sales)
FP-Sales-Apps@Honeywell.com
or
(TAC)
dfs-tac-support@honeywell.com

Specifications are subject to change without notice.

For more information

To learn more about Paperless Recorders,
visit www.honeywellprocess.com
Or contact your Honeywell Account Manager

Process Solutions Honeywell

1250 W Sam Houston Pkwy S
Houston, TX 77042

Honeywell Control Systems Ltd
Honeywell House, Skimped Hill Lane
Bracknell, England, RG12 1EB

Shanghai City Centre, 100 Jungi Road
Shanghai, China 20061

